



# USER MANUAL

GNSS Time Server NTS-x000 Family of Products

**NTS-3000**  
**NTS-4000** OCXO  
**NTS-5000 LITE** OCXO  
**NTS-5000** RUBIDIUM & OCXO  
**NTS-9000** CESIUM MIL & METROLOGY



Updated: May 6<sup>th</sup>, 2020

<b>IMPORTANT SAFETY INSTUCTIONS</b>	<b>4</b>
.	4
<b>ACRONYMS</b>	<b>5</b>
<b>SYNCHRONIZATION TERMS</b>	<b>6</b>
<b>UNDERSTANDING HOLDOVER</b>	<b>8</b>
<b>QUICK START</b>	<b>9</b>
<b>1. QUICK INFO – ABOUT</b>	<b>10</b>
<b>2. QUICK INFO – INTRODUCTION TO NTS SERIES</b>	<b>11</b>
<b>3. QUICK INFO – PRODUCT AT ARRIVAL</b>	<b>12</b>
<b>4. QUICK INFO – INSTALLING HARDWARE</b>	<b>13</b>
<b>5. QUICK INFO – POWERING SERVER OFF/ON</b>	<b>14</b>
<b>6. QUICK INFO – LED INDICATORS ON BOOTING</b>	<b>15</b>
<b>7. QUICK INFO – PANEL KEYBOARD SETUP</b>	<b>17</b>
<b>8. QUICK INFO – LCD MESSAGES</b>	<b>19</b>
<b>9. QUICK INFO – SOFTWARE SETUP LAN (SSH)</b>	<b>20</b>
<b>10. QUICK INFO – TROUBLESHOOTING</b>	<b>23</b>
<b>11. QUICK INFO – UPDATING FIRMWARE</b>	<b>26</b>
<b>12. QUICK INFO – UPDATING EXPANDERS 1-4</b>	<b>27</b>
<b>13. QUICK INFO – RESTORING FACTORY DEFAULTS</b>	<b>30</b>
.	31
<b>HARDWARE</b>	<b>32</b>
<b>14. HARDWARE OF NTS-X000 FAMILY</b>	<b>33</b>
<b>15. HARDWARE OF NTS-3000</b>	<b>35</b>
<b>16. HARDWARE OF NTS-4000 OCXO</b>	<b>36</b>
<b>17. HARDWARE OF NTS-5000 RB &amp; OCXO</b>	<b>37</b>
<b>18. HARDWARE OF NTS-5000 LITE (OCXO ONLY)</b>	<b>39</b>
<b>19. HARDWARE OF NTS-5000 CUSTOM</b>	<b>40</b>
<b>20. HARDWARE OF NTS -5000 IRIG-B DCLS</b>	<b>41</b>
<b>21. HARDWARE OF NTS – THE DSUB9 INTERFACE</b>	<b>42</b>
<b>22. HARDWARE OF NTS-TC (TIME CONVERTER)</b>	<b>43</b>
<b>23. EXTRA HARDWARE – REDUNDANT PWR SUPPLY</b>	<b>44</b>
<b>24. EXTRA HARDWARE – CONNECTING TO CESIUM</b>	<b>45</b>
<b>25. EXTRA HARDWARE – CONNECTING TO 5071A</b>	<b>46</b>
<b>26. EXTRA HARDWARE – GNSS NTS-ANTENNA</b>	<b>55</b>
<b>27. EXTRA HARDWARE – LIGHTING NTS-PROTECT</b>	<b>59</b>
<b>28. EXTRA HARDWARE – FIBER OPTIC CONVERTER</b>	<b>64</b>
.	64
<b>INTRODUCTION</b>	<b>64</b>
.	65
<b>INTERCOM MULTI-MODE FIBER CONNECTION</b>	<b>65</b>
.	65
<b>CONNECTION CONVERTER TO SERVER</b>	<b>65</b>
.	66
<b>CONNECTION CONVERTER TO ANTENNA</b>	<b>66</b>
<b>SOFTWARE SETUP WWW</b>	<b>67</b>
<b>29. SOFTWARE WWW – LOGIN</b>	<b>68</b>
<b>30. SOFTWARE WWW – MAIN SCREEN (SCADA)</b>	<b>69</b>
<b>31. SOFTWARE WWW – NAVIGATING MENU</b>	<b>75</b>
<b>32. SOFTWARE WWW – SAVING &amp; EXIT CONFIG</b>	<b>76</b>
<b>33. SOFTWARE WWW – SETTING GNSS &amp; ANTENNA</b>	<b>78</b>
.	78
<b>SINGLE NTS-ANTENNA SYSTEM</b>	<b>78</b>
.	80
<b>REDUNDANT NTS-ANTENNA SYSTEM (2X ANTENNA)</b>	<b>80</b>
.	82
<b>ANTENNA MODES: IN, OUT (EMULATING NMEA 183)</b>	<b>82</b>
.	84
<b>PRESENTING VISIBILITY OF GNSS SATELLITES</b>	<b>84</b>

. COMPENSATING CABLE LENGTH DELAY	87
. SETTING SYNCHRONIZATION PRIORITY OF ANTENNA	88
. MONITORING SYNCHRONIZATION STATUS OF ANTENNA	88
<b>34. SOFTWARE WWW – SETTING NETWORK</b>	<b>89</b>
. LAN1-LAN2 (STD.)	90
. LAN3-LAN10 (OPTIONAL EXPANDER 1-4 FOR NTS-5000/TC)	90
. PTP IEEE1588 CONFIGURATION LAN3-LAN10	91
<b>35. SOFTWARE WWW – SERVICES</b>	<b>96</b>
. NTP BACKUP SERVERS	96
. IRIG-B/PPS-X MANAGEMENT	98
. SYSLOG/SNTP	101
<b>36. SOFTWARE WWW – SYSTEM SECURITY &amp; DNS</b>	<b>102</b>
.	103
.	103
<b>SOFTWARE SSH</b>	<b>104</b>
<b>37. SOFTWARE SSH - SETUP LAN1-LAN2</b>	<b>105</b>
<b>38. SOFTWARE SSH - SETUP LAN3-LAN10</b>	<b>113</b>
<b>39. NTP SYMMETRIC AUTHENTICATION (MD5)</b>	<b>130</b>
<b>40. SYSLOG</b>	<b>138</b>
<b>41. APPLICATION NOTES HFT (MIFID II)</b>	<b>142</b>
.	144
.	144
<b>USER GUIDE &amp; TUTORIALS</b>	<b>146</b>
<b>42. PTP (PRECISION TIME PROTOCOL) IEEE1588</b>	<b>147</b>
. HOW MANY SLAVES SUPPORTS PTP MASTER?	148
<b>43. SOFTWARE TIME PROTOCOLS</b>	<b>149</b>
. NTP – NETWORK TIME PROTOCOL	149
. SNTP - SIMPLE NETWORK TIME PROTOCOL	150
. PTP – PRECISION TIME PROTOCOL (IEEE1588)	151
. DEYTIME RFC867 RFC868	152
<b>APPENDIX</b>	<b>153</b>

# IMPORTANT SAFETY INSTRUCTIONS

## ATTENTION!

These are the important Safety Instructions that should be followed during installation and maintenance of the ELPROMA timeserver family product.

### IMPORTANT NOTE

This equipment contains hazardous AC and DC voltages. Do not handle any metallic part until the power has been disconnected. Do not assemble, disassemble set when the power is ON. Making wiring and touching cables is strongly prohibited when power is ON. Please refer to your RACK'19 safety instruction to learn more about connecting power to equipment. The NTS-protection system requires PE line to be connected into RACK'19 din rails.

### Elproma safety advises:

1. Safety first! Never work alone under hazardous voltage conditions
2. High short circuit current through conductive materials can cause server burns
3. Check that the power cord(s), plug(s), and sockets are in good conditions
4. Always use qualified service personnel to install permanently wired equipment
5. Do not handle any metallic part before the main power has been disconnected
6. Take care your power lines and rack'19 frame is properly PE grounded

ELPROMA Electronics Poland Sp. z o.o.  
Szymanowskiego Str. 13 PL05092 Lomianki near Warsaw POLAND (EU)  
Phone: +48 227517680  
Fax: +48 227517681  
Internet: <http://www.elpromatime.com>  
e-mail: [info@elpromatime.com](mailto:info@elpromatime.com)

# ACRONYMS

<b>1PPS</b>	1 Pulse Per Second	<b>ITU</b>	International Telecom Union
<b>AIV</b>	Assembly, Integration and Validation	<b>KPI</b>	Key Performance Indicator
<b>BIPM</b>	Bureau International des Poids et Mesures	<b>MCT</b>	Modular Coherent Transfer
<b>CA</b>	Certificate Authority	<b>NMI</b>	National Metrological Institutes
<b>CCTF</b>	Consultative Committee for Time and Frequency	<b>NTA</b>	National Time Authority (mostly the same as NMI)
<b>CIF</b>	Core Infrastructure Facilities	<b>NTP</b>	Network Time Protocol
<b>COTS</b>	Commercial Off-the-Shelf	<b>OFT</b>	Optical Fibber Technology
<b>CV</b>	Common View	<b>OSC</b>	Oscillators (OCXO, Rubidium, Cs)
<b>DAB</b>	Digital Audio Broadcasting	<b>PPP</b>	Point Precise Positioning
<b>DEMETRA</b>	Demonstrator for EGNSS services based on Time Reference Architecture	<b>PTP</b> <b>PTPv2</b>	Precise Time Protocol IEEE 1588 (WR –White Rabbit profile of PTP)
<b>DB</b>	Database (mostly SQL)	<b>QR</b>	Quality Report
<b>DVB</b>	Digital Video Broadcasting	<b>RINEX</b>	Receiver Independent Exchange Format
<b>ETH</b>	Ethernet	<b>RMO</b>	Regional Metrological Organization
<b>EBU</b>	European Broadcast Union	<b>SFN</b>	Single Frequency Network
<b>EGNOS</b>	European geostationary navigation overlay system	<b>SIS</b>	Signal In Space
<b>EGNSS</b>	European GNSS	<b>SPF</b>	Service Provision Facility
<b>EURAMET</b>	European Regional Metrological Organisation	<b>SV</b> <b>SVN#</b>	Satellite Vehicle Satellite Vehicle Number
<b>EWR</b>	Extended White Rabbit	<b>SVF</b>	Service Validation Facility
<b>FO</b>	Fibber Optic	<b>SW</b>	Software
<b>FR</b>	FREE-RUN mode	<b>T&amp;F</b>	Time and(&) Frequency
<b>GCC</b>	Galileo Control Centre	<b>TAI</b>	International Atomic Time
<b>FTP</b>	File Transfer Protocol	<b>TA(PL)</b>	Polish Atomic Time
<b>GDO</b>	GPS Disciplined Oscillator	<b>TDMA</b>	Time Division Multiple Access
<b>GGTO</b>	Galileo GPS Time Offset	<b>TFL</b>	Time and Frequency Laboratory
<b>GMT</b>	Greenwich Mean Time	<b>TLC</b>	Time Local Clock (the same as UT)
<b>GNSS</b>	Global Navigation Satellite System	<b>TMC</b>	Time Master Clock (see TSG)
<b>GPS</b>	Global Positioning System	<b>TRF</b>	Time Reference Facility (see TMC)
<b>GPST</b>	GPS Time Scale	<b>TSA</b>	Time Stamping Authority
<b>GSA</b>	GNSS Supervising Authority	<b>TSI</b>	Time Service Infrastructures
<b>GST</b>	Galileo System Time	<b>TWSTF</b>	Two Way Satellite Time and Frequency Transfer
<b>HTTP</b> <b>HTTPS</b>	Hypertext Transfer Protocol Hypertext Transfer Protocol Secure	<b>UT</b>	User Terminal (see also TLC)
<b>HO</b>	HOLDOVER mode (e.g. operating w/o GNSS)	<b>UTC</b>	Universal Time Coordinated
<b>HW</b>	Hardware	<b>WP</b>	Work Package
<b>IPR</b>	Intellectual Property Rights	<b>WR</b>	White Rabbit (see PTP)
<b>IRIG-B</b>	Time Code (AM or DM)	<b>WPL</b>	Work Package Leader

# SYNCHRONIZATION TERMS

**Accuracy** - The degree of conformity of a measured or calculated value to its definition or with respect to a standard reference time. In the meaning of NTP (Network Time Protocol) the accuracy determines how close the PC clock is to UTC reference (GNSS or external atomic clock).

**Atomic Time Scale (TA)** - a time scale based on atomic or molecular resonance phenomena. Elapsed time is measured by counting cycles of a frequency locked to an atomic or molecular transition. Earlier time scales were based on the rotational rate of the earth.

**GBEIDOU**– (see COMPASS)

**Calibration** - The process of identifying and measuring time or frequency errors, offsets, or deviations of a clock/oscillator relative to an established standard, such as UTC(NIST).

**Clock** - a device for maintaining and displaying time.

**GOMPASS (BEIDOU)**– is Chinese satellite navigation system. It consists of two separate satellite constellations – a limited test system that has been operating since 2000, and a full-scale global navigation system that is currently under construction. The first BeiDou system, officially called the BeiDou Satellite Navigation Experimental System.

**Coordinated Universal Time (UTC)** - a coordinated time scale, maintained by the Bureau International des Poids et Mesures (BIPM), which forms the basis of a coordinated dissemination of standard frequencies and time signals. A UTC clock has the same rate as a Temps Atomique International (TAI) clock or international atomic time clock but differs by an integral number of seconds called leap seconds. The UTC scale is adjusted by the insertion or deletion of leap seconds to ensure approximate agreement with UT1.

**Drift (frequency)** - the linear (first-order) component of a systematic change in frequency of an oscillator over time.

**Frequency** - the rate at which a periodic phenomenon occurs over time. **Frequency drift** - see drift. **Frequency offset** - the frequency difference between the measured value and the defined value. **Frequency shift** - change in frequency from a standard reference. **Frequency stability** - statistical estimate of the frequency fluctuations of a signal over a given time interval.

**Frequency standard** - an oscillator such as a rubidium (Rb), cesium (Cs), or hydrogen (H) maser whose output is used as a frequency.

**GALILEO** – is a global navigation satellite system (GNSS) currently being built by the European Union (EU) and European Space Agency (ESA). One of the aims of Galileo is to provide a high-precision positioning system upon which European nations can rely, independently from the Russian GLONASS, US GPS, and Chinese COMPASS (BEIDOU) which can be disabled in times of war or conflict. Galileo is compatible to US GPS (see GPS).

**GLONASS** – acronym for **Globalnaya navigatsionnaya sputnikovaya sistema** or **Global Navigation Satellite System**, is a space-based satellite navigation system operated by the Russian Aerospace Defence Forces. It provides an alternative to Global Positioning System (GPS) and is the only alternative navigational system in operation with global coverage and of comparable precision. Glonass use L1-1575.42MHz with additional frequency margin between 1597.50-1609.50Mhz.

**GPS (Global Positioning System)** - a highly accurate, global satellite navigation system based on a constellation of at 24 satellites orbiting the earth at a very high altitude 20000 km. GPS signals are: L1-1575.42MHz;L2-1227.6MHz;L3-1381.05 MHz

**GMT (Greenwich Mean Time)** - a 24 Hour system based on mean solar time plus 12 hours at Greenwich, England. Greenwich Mean Time can be considered approximately equivalent to Coordinated Universal Time (UTC), which is broadcast from all standard time and frequency radio stations. However, GMT is now obsolete and has been replaced by UTC.

**International Atomic Time (TAI)** - an atomic time scale based on data from a worldwide set of atomic clocks. It is the internationally agreed upon time reference conforming to the definition of the second, the fundamental unit of atomic time in the International System of Units (SI). It is defined as the duration

of 9 192 631 770 periods of the radiation corresponding to the transition between two hyperfine levels of the ground state of the cesium - 133 atom.

**Synchronization** - The process of measuring the difference in time of two time scales such as the output signals generated by two clocks. In the context of timing, synchronization means to bring two clocks or data streams into phase so that their difference is 0 (see time scales in synchronism).

**Synchronization** - Relative adjustment of two frequency sources with the purpose of canceling their frequency difference but not necessarily their phase difference.

**Stability (frequency)** - statistical estimate of the frequency fluctuations of a signal over a given time interval: **Long term** stability usually involves measurement averages beyond 100s. **Short term** stability usually involves measurement averages from a few tenths of a second to 100s.

**Stratum** - indicates how far from cesium ref. the clock is in the chain of synchronization.

**Time code** - a system of symbols (digital or analog) used for identifying specific instants of time. An information format used to convey time information. IRIG-B is example of Time Code.

**Time interval** - The duration between two instants read on the same time scale.

**Time scale** - a system of unambiguous ordering of events. A time scale is meant to be stable and homogeneous.

**Time standard** - a continuously operated device used for the realization of a time scale in accordance with the definition of the second and with an appropriately chosen origin.

**Time step** - a discontinuity in a time scale at some instant. A step is positive (+) if the time scale reading is increased and negative (-) if the reading is decreased at that instant.

# UNDERSTANDING HOLDOVER

Customers frequently ask the question “How long timeserver can operate holdover w/o GNSS signals”. The answer depends on built-in oscillator and requested output NTP/PTP accuracy to UTC. Depends on server model, Elproma supports following oscillators:

- NTS-3000 **quartz** (optionally OCXO)
- NTS-4000 **OCXO**
- NTS-5000 LITE **OCXO**
- NTS-5000 **RUBIDIUM & OCXO**

Higher accuracy request means shorter holdover time interval supported by the same oscillator. Independently, each of product can be extra-ordinary equipped with TCXO chip clocking ensuring the low-noise operation. As a side effect the TCXO can be considered as alternative holdover. It also can be used simultaneously with other oscillators.

Holdover Time (NO GNSS)	MAX. TIME ERROR WHEN BASIS ON OSCILLATOR		
	Rubidium	OCXO	TCXO
1 second	0,1 [ns]	5 [ns]	900 [ns]
1 minute	0,01 [μs]	0,3 [μs]	54 [μs]
1 hour	0,03 [μs]	0,5 [μs]	3 240 [μs]
1 day	0,76 [μs]	47 [μs]	77 760 [μs]
1 week	0,01 [ms]	2,2 [ms]	544 [ms]
1 month	0,15 [ms]	39 [ms]	2 000 [ms]
6 months	5 [ms]	400 [ms]	14 000 [ms]
1 year	0,016 [s]	1,6 [s]	28 [s]

### IMPORTANT NOTE!

Above figures basis on several important assumptions:

- **Server operates in constant temperature**
- **No initial phase and frequency error**
- **Time server device has been powered for one month and locked to GNSS for 72 hours**

## Difference between Accuracy and Stability of Synchronization



ACCURATE & STABLE

STABLE BUT NOT ACCURATE

NOT ACCURATE - NOT STABLE

JITTER



**QUICK START**

# **Configure In 5 Minutes**

# 1. QUICK INFO – About

If you currently are reading this manual, you have probably found below card sticked to your new owned ELPROMA NTS-3000, 4000 5000 timeservers (called also later in this manual shortly, the NTS-x000).



This is very good, because:

- 1) First of all, we would like to thank you very much for choosing ELPROMA
- 2) Secondly, please recheck periodically and download latest version of this User Manual from:  
[www.download.elpromatime.com](http://www.download.elpromatime.com)
- 3) But also, it is very important to let us know your feedback e-mail address, so we can inform you about new firmware releases and software patches. This can be done as simple as sending below text message to e-mail address: [ntp@elpromatime.com](mailto:ntp@elpromatime.com) :

*“Hi, I have just owned Elproma NTS-3000 S/N 0023876”*

- 4) You can use any time your free support e-mails asking questions:  
[support@elpromatime.com](mailto:support@elpromatime.com) - Note! It is requiring providing server model and S/N

## 2. QUICK INFO – Introduction to NTS series

This manual cover ELPROMA time servers (shortly **NTS-x000**): **NTS-3000, NTS-4000, NTS-5000, NTS-5000LITE, NTS-9000, NTS-TC** time converter.

All servers are STRATUM-1 NTP time servers. All servers are PTP IEEE1588 Grand Masters Clocks. They are synchronized to STRATUM-0 sources of UTC. The default ref. source of time is GNSS L1 carrier supporting GPS + GLONASS. Other satellite systems as BEIDOU\* or GALILEO\* are optional.

Servers can be also synchronized to any other local or remote UTC ref. clocks using additional I/O interfaces: 1PPS (PPM\*, PPH\*), 10MHz, IRIG-B AM or DCLS, IBM SYSPLEX. Other not std. interfaces are available on request too.

The main difference between models is a built-in **holdover** (HO) **oscillator** (OSC) type. Oscillator ensures synchronization continuum when timeserver cannot receive GNSS satellite signals. To operate in HO mode, the OSC must be synchronized to GNSS first. Please ref. to begin of this manual to understand holdover operation.

Server model **NTS5000/NTS5000LITE** optionally supports additional **Expander 1-4** Network Interface Card. Each Expander NIC supports 2x GE Ethernet with low level hardware timestamping. Cards are 100% information isolated from each other. Expander nr. 1 (NIC) is very special one. It can operate in Slave mode for synchronization to other PTP IEEE1588 devices. The hardware PHY timestamping ensures ultra-high accuracy of synchronization represented in level of tens of nanoseconds [ns].

All Elproma servers support simultaneously I/O inputs providing ref. sources of UTC time. However, only one reference is taken in time following user-definable PRIORITY TABLE and other stays ready for backup. There is a special priority management system in the WEB SETUP that is letting you maintain all resources and its priorities. Time ref. sources can be defined into 3 groups of ref. time:

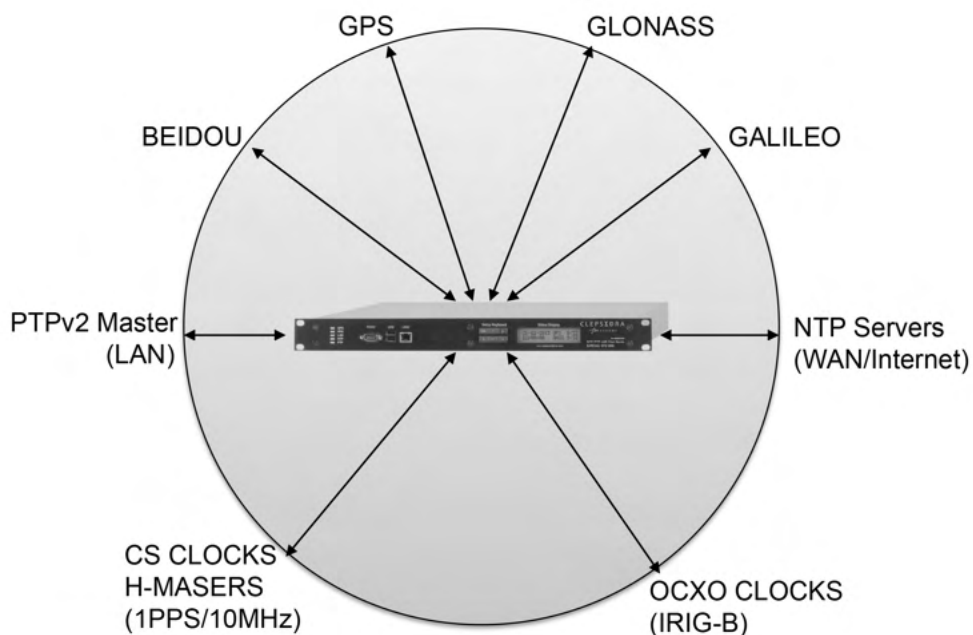

- |                        |   |
|------------------------|---|
| 1) <b>GNSS</b>         | using sub-systems: <i>GPS, GLONASS, GALILEO*, BEIDOU*</i> |
| 2) <b>NETWORK</b>      | using protocols: <i>NTP, PTP IEEE1588</i>                 |
| 3) <b>LOCAL CLOCKS</b> | using signals: <i>PPS, RS-232, RS-485, IRIG-B</i>         |



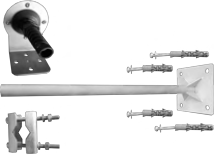

*Elproma Time Servers are unique – they take ref. time simultaneously from all available I/O sources*

### 3. QUICK INFO – Product at arrival

Standard product pack includes:

1.	NTS-x000 Network Time Server	1pcs.	
2.	NTS-antenna w/ built-in GNSS receiver	1pcs.	
3.	Roof Mounting Kit Incl. mast H=0,5m, Set of screws, handlers etc.	1set	
5.	Ethernet patch cord UTP cat. 5 (2m)	2pcs.	
6.	Power cable (1.5m)	1pcs.	

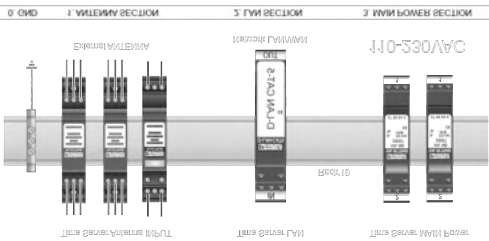
Extra options\* (need to be ordered separately):

a.	2 <sup>nd</sup> NTS-antenna	extra 1pcs.	(see above table)
b.	2 <sup>nd</sup> Roof Mounting Kit	extra 1set.	(see above table)
c.	NTS-protect surge/overvoltage arresters	1 set.	
d.	FO-01 Converter electric-2-fibber	2pcs. (1set)	

#### Important Notes!

The antenna cable is not included to product and should be purchased locally (min UTP or STP cat 5).  
Manual and software need to be downloaded from web page [www.elpromatime.com](http://www.elpromatime.com).

## 4. QUICK INFO – Installing hardware

Quick unpacking/mounting steps:

1. Remove all parts from shipped box. Prepare additional tools: (1) RJ45 connectors (pcs.2), (2) UTC/STP cable cat.5 or above (not included to shipment), (3) Ethernet crimping tool, (4) screwdriver & scissors.

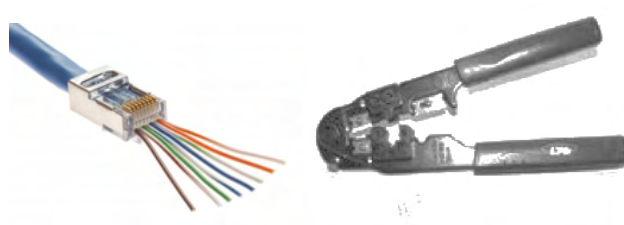

2. Always mount GNSS receiver (NTS-antenna) on the top point of the roof of building. Antenna should access possible a 360° sky view (unobstructed view of the sky) to receive all available, not reflected satellite signals. Do not mount GNSS receiver: on the building wall, on chimney, near electric engines (e.g. air-condition). Always avoid reflections from any other structures. The minimum recommended distance from other antennas is at least 2 meters.

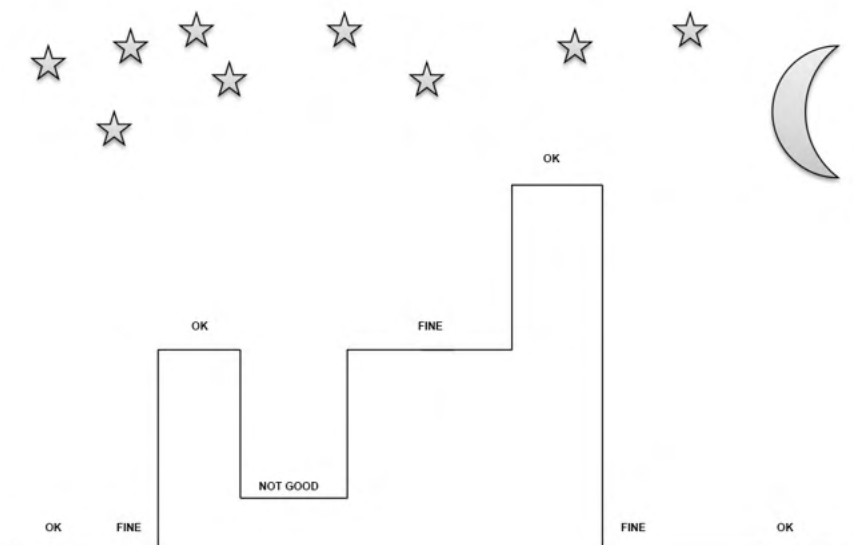

3. Lunch UTP (STP) antenna cable down to datacenter room. Measure and note a total length of used a cable for future signal delay compensation (4ns/m to be set at server www setup-level). Cables should not be located in direct neighborhood to any power line. Well done cable installation should be tested for connectivity and resistance before using. Ensure that building fire regulations do not volatile. Always consider using overvoltage protection and surge arresters.
4. Mount NTS-surge protection on the back of rack'19 shell. Ensure, it is properly grounded to PE line (yellow-green marked). Ask, certified authority to assist you at this step, especially if you are not qualified for electric installations. Always read all safety instructions first!
5. Crimp RJ45 connectors to terminate antenna cables at time-server side and test connections.
6. Locate Time Server in rack"19 shell. Please keep min. 1U space to neighborhood other products that can unexpectedly hit your NTS-x000 time-server from top and bottom surface.

## 5. QUICK INFO – Powering Server OFF/ON

Turn ON the power switch located on the back panel of NTS-x000 server. In case of redundant power each power supply has own ON-OFF separate **switch**.

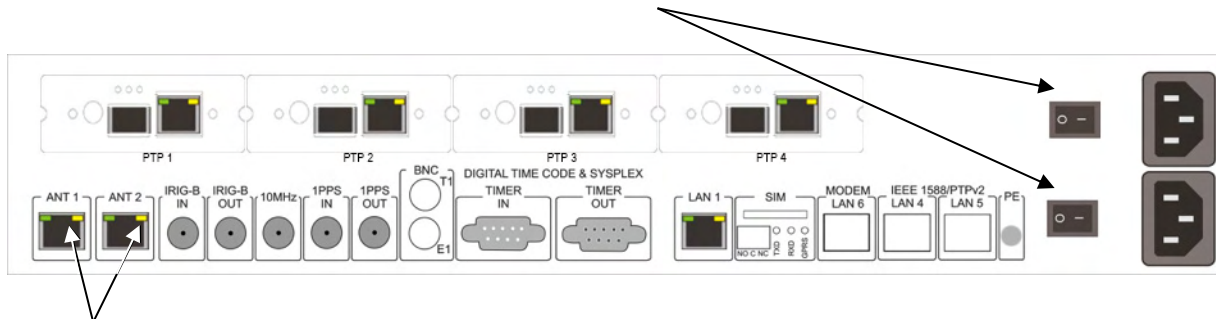

The ANT1/ANT2 RJ45 YELLO LED starts pulse (PPS) max. 1 minute after switching power ON. Typical firmware start-up time duration takes 1 minute, but this can take longer too. Firmware BOOT progress can be **traced on front panel 6x LED** and **2x20 LCD display** of front panel.

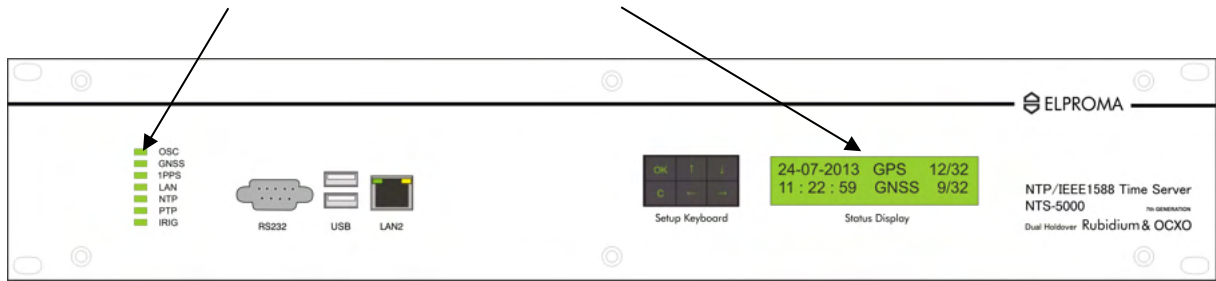





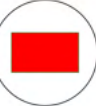
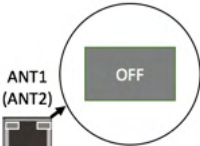

Observe LCD and LED during BOOT process. Ensure GNSS synchronization is indicated by OK status (LCD) and green color LED too.

Use front panel KEYBOARD and SETUP device by entering LAN1-2 basic IPv4 configuration.

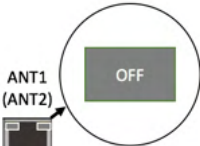
## 6. QUICK INFO – LED Indicators On Booting

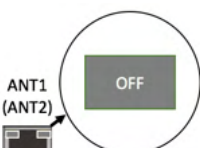
Following **boot sequence** can be observed:

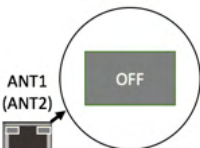
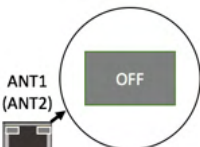
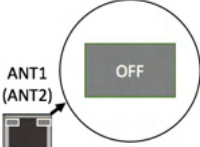
#Lp	Process	Time duration	6x LED (Front Panel - left)	LCD display (Front Panel right side)	ANT1/ANT2 (Back Panel)																																
1	OFF-ON	1s	<ul style="list-style-type: none"> <li><span style="color: red;">■</span> OSC</li> <li><span style="color: red;">■</span> GNSS</li> <li><span style="color: red;">■</span> 1PPS</li> <li><span style="color: red;">■</span> LAN</li> <li><span style="color: red;">■</span> NTP</li> <li><span style="color: red;">■</span> PTP</li> <li><span style="color: red;">■</span> IRIG</li> </ul> 	<div style="background-color: #90EE90; padding: 5px; border: 1px solid black; text-align: center;"> <b>(C) 2019 ELPROMA</b>  <b>www.ntp-servers.com</b> </div>	 <p>Yellow LED is OFF</p>																																
2	HW INIT	1s	<ul style="list-style-type: none"> <li><span style="color: yellow;">■</span> OSC</li> <li><span style="color: yellow;">■</span> GNSS</li> <li><span style="color: yellow;">■</span> 1PPS</li> <li><span style="color: yellow;">■</span> LAN</li> <li><span style="color: yellow;">■</span> NTP</li> <li><span style="color: yellow;">■</span> PTP</li> <li><span style="color: yellow;">■</span> IRIG</li> </ul> 	<div style="background-color: #90EE90; padding: 5px; border: 1px solid black; text-align: center;"> <b>(C) 2019 ELPROMA</b>  <b>www.ntp-servers.com</b> </div>	 <p>Yellow LED is OFF</p>																																
3	SW INIT	1s	<ul style="list-style-type: none"> <li><span style="color: green;">■</span> OSC</li> <li><span style="color: green;">■</span> GNSS</li> <li><span style="color: green;">■</span> 1PPS</li> <li><span style="color: green;">■</span> LAN</li> <li><span style="color: green;">■</span> NTP</li> <li><span style="color: green;">■</span> PTP</li> <li><span style="color: green;">■</span> IRIG</li> </ul> 	<div style="background-color: #90EE90; padding: 5px; border: 1px solid black; text-align: center;"> <b>Boot Loader V16.0120</b>  <b>Loading</b> </div>	 <p>Yellow LED is OFF</p>																																
4	BOOT LOADER	<1min (60s)	<ul style="list-style-type: none"> <li><span style="color: green;">■</span> OSC</li> <li><span style="color: green;">■</span> GNSS</li> <li><span style="color: green;">■</span> 1PPS</li> <li><span style="color: green;">■</span> LAN</li> <li><span style="color: green;">■</span> NTP</li> <li><span style="color: green;">■</span> PTP</li> <li><span style="color: green;">■</span> IRIG</li> </ul> 	<div style="background-color: #90EE90; padding: 5px; border: 1px solid black; text-align: center;"> <b>Loading      NTS-5000</b>              .....         </div>	 <p>Yellow LED is OFF</p>																																
5	OS INIT	<5s	<table style="font-size: small; border-collapse: collapse; width: 100%;"> <tr> <td style="border: 1px solid black; padding: 2px;">Down</td> <td style="border: 1px solid black; padding: 2px;">Up ↑</td> <td style="border: 1px solid black; padding: 2px;">Down</td> <td style="border: 1px solid black; padding: 2px;">OSC</td> </tr> <tr> <td style="border: 1px solid black; padding: 2px;">■</td> <td style="border: 1px solid black; padding: 2px;">■</td> <td style="border: 1px solid black; padding: 2px;">■</td> <td style="border: 1px solid black; padding: 2px;">■</td> </tr> <tr> <td style="border: 1px solid black; padding: 2px;">■</td> <td style="border: 1px solid black; padding: 2px;">■</td> <td style="border: 1px solid black; padding: 2px;">■</td> <td style="border: 1px solid black; padding: 2px;">GNSS</td> </tr> <tr> <td style="border: 1px solid black; padding: 2px;">■</td> <td style="border: 1px solid black; padding: 2px;">■</td> <td style="border: 1px solid black; padding: 2px;">■</td> <td style="border: 1px solid black; padding: 2px;">1PPS</td> </tr> <tr> <td style="border: 1px solid black; padding: 2px;">■</td> <td style="border: 1px solid black; padding: 2px;">■</td> <td style="border: 1px solid black; padding: 2px;">■</td> <td style="border: 1px solid black; padding: 2px;">LAN</td> </tr> <tr> <td style="border: 1px solid black; padding: 2px;">■</td> <td style="border: 1px solid black; padding: 2px;">■</td> <td style="border: 1px solid black; padding: 2px;">■</td> <td style="border: 1px solid black; padding: 2px;">NTP</td> </tr> <tr> <td style="border: 1px solid black; padding: 2px;">■</td> <td style="border: 1px solid black; padding: 2px;">■</td> <td style="border: 1px solid black; padding: 2px;">■</td> <td style="border: 1px solid black; padding: 2px;">PTP</td> </tr> <tr> <td style="border: 1px solid black; padding: 2px;">■</td> <td style="border: 1px solid black; padding: 2px;">■</td> <td style="border: 1px solid black; padding: 2px;">■</td> <td style="border: 1px solid black; padding: 2px;">IRIG</td> </tr> </table>	Down	Up ↑	Down	OSC	■	■	■	■	■	■	■	GNSS	■	■	■	1PPS	■	■	■	LAN	■	■	■	NTP	■	■	■	PTP	■	■	■	IRIG	<div style="background-color: #90EE90; padding: 5px; border: 1px solid black; text-align: center;"> <b>Press &amp; hold [OK]</b>  <b>to enter setup</b> </div>	 <p>Yellow LED is OFF</p>
Down	Up ↑	Down	OSC																																		
■	■	■	■																																		
■	■	■	GNSS																																		
■	■	■	1PPS																																		
■	■	■	LAN																																		
■	■	■	NTP																																		
■	■	■	PTP																																		
■	■	■	IRIG																																		
6	OS READY	<2s	<ul style="list-style-type: none"> <li><span style="background-color: gray; border: 1px solid black; padding: 2px;">OFF</span> OSC</li> <li><span style="background-color: gray; border: 1px solid black; padding: 2px;">OFF</span> GNSS</li> <li><span style="background-color: gray; border: 1px solid black; padding: 2px;">OFF</span> 1PPS</li> <li><span style="background-color: gray; border: 1px solid black; padding: 2px;">OFF</span> LAN</li> <li><span style="background-color: gray; border: 1px solid black; padding: 2px;">OFF</span> NTP</li> <li><span style="background-color: gray; border: 1px solid black; padding: 2px;">OFF</span> PTP</li> <li><span style="background-color: gray; border: 1px solid black; padding: 2px;">OFF</span> IRIG</li> </ul>	<div style="background-color: #90EE90; padding: 5px; border: 1px solid black; text-align: center;"> <b>Press &amp; hold [OK] [C]</b>  <b>to reset to defaults</b> </div>	 <p>Yellow LED is OFF</p>																																

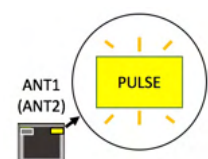
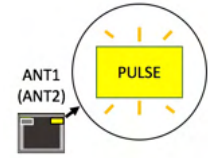
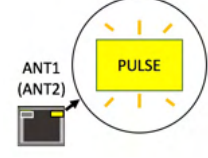
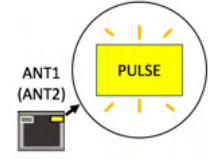
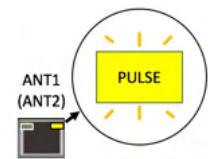
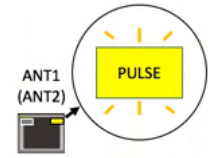
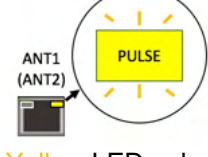
7	NET INIT	<2s	<ul style="list-style-type: none"> <li><input type="checkbox"/> OFF <input checked="" type="checkbox"/> ON <input checked="" type="checkbox"/> OSC</li> <li><input type="checkbox"/> OFF <input checked="" type="checkbox"/> ON <input checked="" type="checkbox"/> GNSS</li> <li><input type="checkbox"/> OFF <input checked="" type="checkbox"/> ON <input checked="" type="checkbox"/> 1PPS</li> <li><input type="checkbox"/> OFF <input checked="" type="checkbox"/> ON <input checked="" type="checkbox"/> LAN</li> <li><input type="checkbox"/> OFF <input checked="" type="checkbox"/> ON <input checked="" type="checkbox"/> NTP</li> <li><input type="checkbox"/> OFF <input checked="" type="checkbox"/> ON <input checked="" type="checkbox"/> PTP</li> <li><input type="checkbox"/> OFF <input checked="" type="checkbox"/> ON <input checked="" type="checkbox"/> IRIG</li> </ul>	<div style="border: 1px solid black; background-color: #90EE90; padding: 5px; text-align: center;"> <b>15-06-2019 OK</b>  <b>17:17:37 SAT A=0/0</b> </div> <p style="text-align: center;">GNSS RECEIVING IF  <b>YELLOW LED PULSE 1PPS</b></p>	 <p>Yellow LED pulse</p>
8	NTP READY LAN Link (-)	+1min (+60s)	<ul style="list-style-type: none"> <li><input checked="" type="checkbox"/> OSC</li> <li><input checked="" type="checkbox"/> GNSS</li> <li><input checked="" type="checkbox"/> 1PPS</li> <li><input checked="" type="checkbox"/> LAN</li> <li><input checked="" type="checkbox"/> NTP</li> <li><input type="checkbox"/> OFF PTP</li> <li><input checked="" type="checkbox"/> IRIG</li> </ul>	<div style="border: 1px solid black; background-color: #90EE90; padding: 5px; text-align: center;"> <b>15-06-2019 INIT</b>  <b>17:17:37 SAT A=0/0</b> </div>	 <p>Yellow LED pulse</p>
9	GNSS READY	+6min (+360s) max	<ul style="list-style-type: none"> <li><input checked="" type="checkbox"/> OSC</li> <li><input checked="" type="checkbox"/> GNSS</li> <li><input checked="" type="checkbox"/> 1PPS</li> <li><input checked="" type="checkbox"/> LAN</li> <li><input checked="" type="checkbox"/> NTP</li> <li><input type="checkbox"/> OFF PTP</li> <li><input checked="" type="checkbox"/> IRIG</li> </ul>	<div style="border: 1px solid black; background-color: #90EE90; padding: 5px; text-align: center;"> <b>15-06-2019 OK</b>  <b>17:17:37 SAT A=17/30</b> </div> <p style="text-align: center;"><i>ToD millisecond accuracy of synchronization has been started</i></p>	 <p>Yellow LED pulse</p>
10	1PPS READY	+6min (+360s) max	<ul style="list-style-type: none"> <li><input checked="" type="checkbox"/> OSC</li> <li><input checked="" type="checkbox"/> GNSS</li> <li><input checked="" type="checkbox"/> 1PPS</li> <li><input checked="" type="checkbox"/> LAN</li> <li><input checked="" type="checkbox"/> NTP</li> <li><input type="checkbox"/> OFF PTP</li> <li><input checked="" type="checkbox"/> IRIG</li> </ul>	<div style="border: 1px solid black; background-color: #90EE90; padding: 5px; text-align: center;"> <b>15-06-2019 OK</b>  <b>17:18:47 SAT A=19/30</b> </div> <p style="text-align: center;"><i>Microsecond [us] to nanosecond [ns] high accuracy of 1 PPS synchronization has started now</i></p>	 <p>Yellow LED pulse</p>
11	IRIG READY	+2min (+180s) max	<ul style="list-style-type: none"> <li><input checked="" type="checkbox"/> OSC</li> <li><input checked="" type="checkbox"/> GNSS</li> <li><input checked="" type="checkbox"/> 1PPS</li> <li><input checked="" type="checkbox"/> LAN</li> <li><input checked="" type="checkbox"/> NTP</li> <li><input type="checkbox"/> OFF PTP</li> <li><input checked="" type="checkbox"/> IRIG</li> </ul>	<div style="border: 1px solid black; background-color: #90EE90; padding: 5px; text-align: center;"> <b>15-06-2019 OK</b>  <b>17:18:47 SAT A=19/30</b> </div>	 <p>Yellow LED pulse</p>
12	OSC READY	+10min (+600s) max	<ul style="list-style-type: none"> <li><input checked="" type="checkbox"/> OSC</li> <li><input checked="" type="checkbox"/> GNSS</li> <li><input checked="" type="checkbox"/> 1PPS</li> <li><input checked="" type="checkbox"/> LAN</li> <li><input checked="" type="checkbox"/> NTP</li> <li><input type="checkbox"/> OFF PTP</li> <li><input checked="" type="checkbox"/> IRIG</li> </ul>	<div style="border: 1px solid black; background-color: #90EE90; padding: 5px; text-align: center;"> <b>15-06-2019 OK</b>  <b>17:18:47 SAT A=19/30</b> </div>	 <p>Yellow LED pulse</p>
13	ETH Link (+) LAN1 or LAN2		<ul style="list-style-type: none"> <li><input checked="" type="checkbox"/> OSC</li> <li><input checked="" type="checkbox"/> GNSS</li> <li><input checked="" type="checkbox"/> 1PPS</li> <li><input checked="" type="checkbox"/> LAN</li> <li><input checked="" type="checkbox"/> NTP</li> <li><input type="checkbox"/> OFF PTP</li> <li><input checked="" type="checkbox"/> IRIG</li> </ul>	<div style="border: 1px solid black; background-color: #90EE90; padding: 5px; text-align: center;"> <b>15-06-2019 OK</b>  <b>17:18:47 SAT A=19/30</b> </div>	 <p>Yellow LED pulse</p>



## 7. QUICK INFO – Panel Keyboard SETUP

After **switching ON** power the following screen sequence will appear on LCD display:



When booting, the following message will be displayed while dots indicates booting progress:

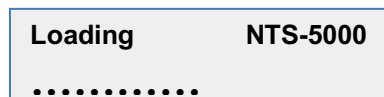

You are now able to configure IPv4 address of LAN1 and LAN2. Both LAN1/LAN2 are std. network interfaces available at all Elproma time servers. Expander LAN3-LAN10 cannot be configured from front panel keyboard.

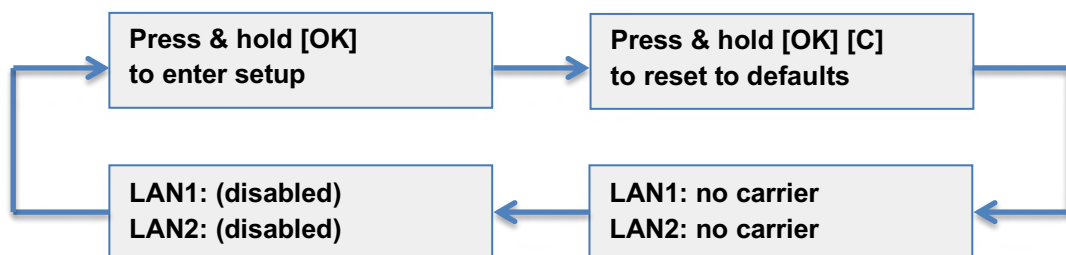

Press & hold [OK] for min. 5s. The **LAN1** IP address will appear on LCD. Use arrow keys [**←→**] to select IPv4 position, and [**↑↓**] to assign requested value 0-9.

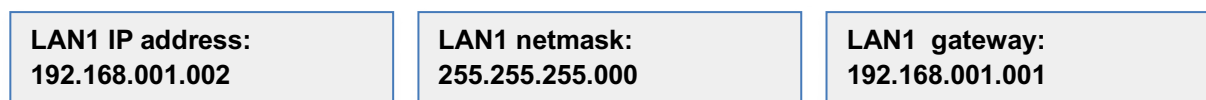

Press [OK] to switch to next screen or **press & hold [OK]** for 5s to save configuration. You can always interrupt and quit SETUP w/o saving at any moment by **pressing & holding [C]**. Repeat above steps to configure LAN2 IP address:

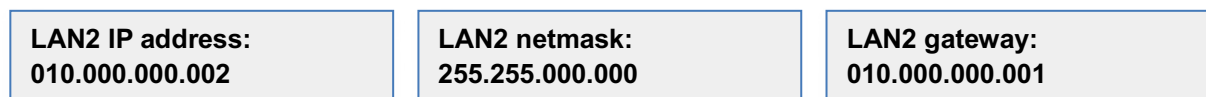

Once IPv4 address is set, the following screen request is displayed to save setting:

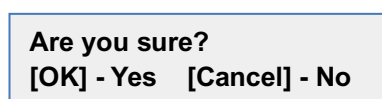

Now NTS-x000 timeserver is ready to communicate via LAN1 (LAN2). Unless you like to provide more advances setting, the above simple IPv4 configuration is the minimum required to start working server.

If the GNSS receiver remains not synchronized the following INIT information will be displayed on LCD:

```
15-07-2018    INIT
23:00:11
```

Once more than 3 satellites are in view, the GNSS receiver is ready and synchronization is pending:

```
15-07-2018    OK
23:01:00  SAT  A= 18/32
```

If you use 2 redundant GNSS receivers (Ant1 & Ant2), additional information will be displayed too for B:

```
15-07-2018    OK
23:01:01  SAT  B= 19/32
```

It is frequently that both GNSS receivers can show a different volume of visible satellites.

```
15-07-2018    GPS 11/32
23:01:17    GNSS 9/32
```

Following additional information can be provided any time:

```
Firmware release
NTS-5000    15/06/2019
```

Environmental DATA is provided periodically:

```
CPU temperature [C]
+41.5 +36.8 +25.1
```

```
CPU temperature [F]
+106,7 +98,2 +77,1
```

```
Onboard voltage [V]
+3.32 +5.03 +15.54
```

Plugging Ethernet cable to LAN1 will trigger Link(+) and following message will be displayed on LCD:

```
LAN1: no carrier
LAN2: no carrier
```

```
LAN1: active
LAN2: no carrier
```

```
LAN1: 192.168.1.2
LAN2: (disabled)
```

## 8. QUICK INFO – LCD Messages

If there is **no antenna** connected to server, the following error screen is displayed on LCD front panel:

```
15-07-2018 ERRsats
23:35:21 ANT ERROR
```

*Error: no antenna detected, antenna error or cable connection is broken*

Time server is requiring min. 3 satellites in order to set localization and time from GNSS. If it receives less than 3 satellites or quality of satellite signals is not good enough, server will display ERRsats with specific number of visible satellites at receiver A or B:

```
15-07-2018 ERRsats
23:38:28sat A=1/12
```

*Error: missing GNSS satellites or bad GNSS geometry (should be min 5-sat visible)*

Nevertheless, in both above cases the NTS-x000 automatically switch to HOLDOVER mode. In HOLDOVER mode, a time is not provided from GNSS but from built-in oscillator OSC (OCXO or RUBIDIUM – if supported). The Rubidium (Rb) is available for NTS-5000 only. NTS-4000 supports OCXO. Standard version of NTS-3000 does not include any oscillator and therefore it does not support HOLDOVER mode.

To provide accurate time in HOLDOVER mode, oscillators (OCXO and Rubidium) must be synchronized to GNSS first. If server has never reached synchronization to GNSS, the oscillators reminds FREE-RUN mode and they cannot be use. The NTS-x000 state machine never use oscillators when previously not synchronized to GNSS. However, if HOLDOVER mode is overdue, the oscillator can drift providing growing large error to UTC. In some cases the time overdue is also called a FREE-RUN mode.

The LCD shows only a status of the GNSS antennas. It does not show status of the other time sources like 1PPS, IRIG, SYSPLEX etc. However, all other time ref. UTC sources can be traced remotely using built-in software (**ntpq**). The **ntpq** is built-in to NTS server and can be accessed by SSH/TELNET setup.

Another kind of “ERR sync” message is possible, if a quality of received satellite signals is not fine enough. This problem might happen when GNSS signal is noisy, reflected or jammed/spoofed.

```
17-02-2018 ERRsync
08:02:21sat A=5/12
```

*Error: GNSS not in sync mode*

The last, but not least is critical error message - “**Error call service**”. It highlights device is not operating.

```
Error call service
+48 (22) 7517680
```

*Error: Device out of order*

## 9. QUICK INFO – Software Setup LAN (SSH)

NTS-x000 configuration can be done using **LAN1** or **LAN2** network interface. This also including the configuration of LAN3-LAN10 (Expander1-4) interfaces of NTS-5000/TC models. We recommend to use SSH protocol. The factory defaults for software SETUP are: *Username -> admin; Password -> 12345*

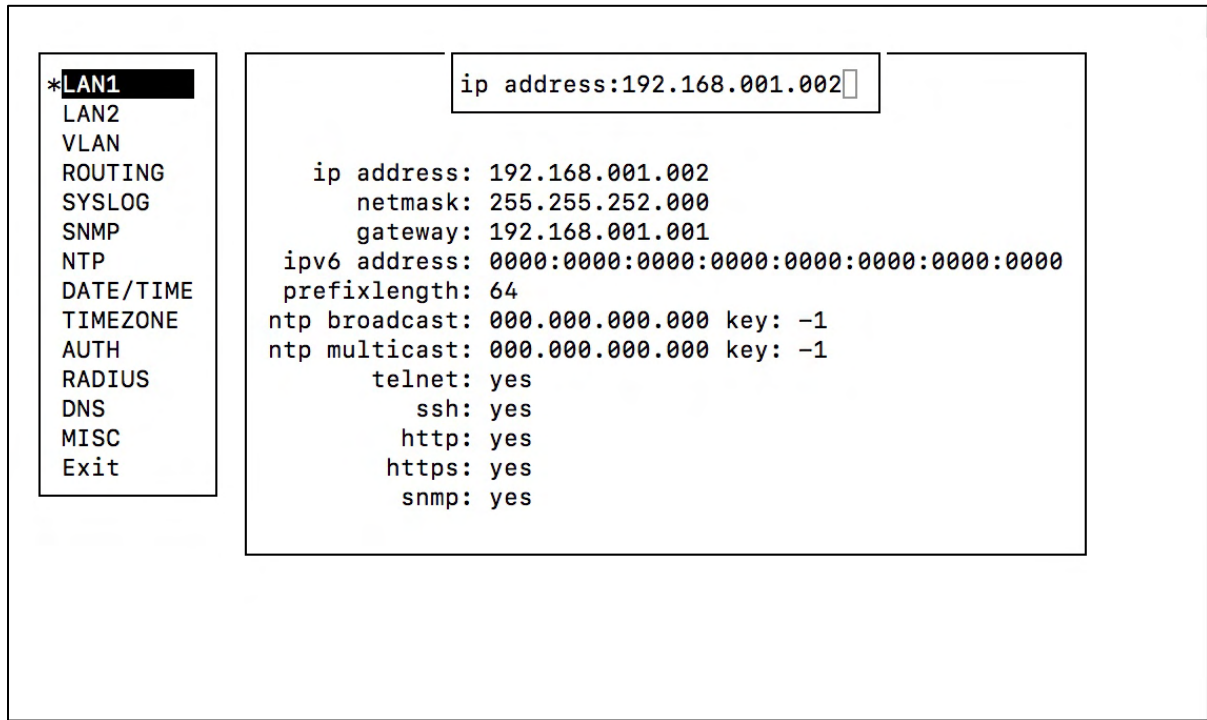

The screenshot shows a configuration menu with a sidebar on the left and a main configuration area on the right. The sidebar contains the following options: \*LAN1 (highlighted), LAN2, VLAN, ROUTING, SYSLOG, SNMP, NTP, DATE/TIME, TIMEZONE, AUTH, RADIUS, DNS, MISC, and Exit. The main area displays the IP address configuration for LAN1: ip address: 192.168.001.002. Below this, a list of network parameters is shown: ip address: 192.168.001.002, netmask: 255.255.252.000, gateway: 192.168.001.001, ipv6 address: 0000:0000:0000:0000:0000:0000:0000:0000, prefixlength: 64, ntp broadcast: 000.000.000.000 key: -1, ntp multicast: 000.000.000.000 key: -1, telnet: yes, ssh: yes, http: yes, https: yes, and snmp: yes.

Since, LAN3-LAN10 interfaces are physically isolated from each other, the Expander 1-4 configuration goes in special protected mode and via LAN1-LAN2. To configure LAN3-LAN10 please select PTP:



The screenshot shows the same configuration menu as above, but with the sidebar options changed. The options are: LAN1, LAN2, ROUTING, SYSLOG, SNMP, NTP, DATE/TIME, TIMEZONE, AUTH, RADIUS, DNS, MISC, \*PTP (highlighted), and Exit. The main configuration area is currently empty.



The new setup (different color) screen appears after selecting PTP item from main setup menu. Different color indicates fact that you have entered the security zone of NTS-5000/TC. New menu style includes automatically recognized Expander 1-4 NIC cards. Cards are numbered: PTP1 (Expander 1), PTP2 (Expander 2), PTP3 (Expander 3), PTP4 (Expander 4). Only cards that are recognized by NTS system are displayed.

You will need to configure each 1-4 Expander NIC card separately. Each card includes 2 independent network interfaces: 1x electric (RJ45) and 1x SFP – that can be set to operate fiber-optic or electric Ethernet signals. The Expander 1-4 NIC are numbered:

- Expander #1** supported by: NTS-5000, NTS-TC  
LAN3: RJ45 electric GE interface  
LAN4: SFP fiber or electric GE interface
- Expander #2** supported by: NTS-5000, NTS-TC  
LAN5: RJ45 electric GE interface  
LAN6: SFP fiber or electric GE interface
- Expander #3** supported by: NTS-5000 only  
LAN3: RJ45 electric GE interface  
LAN4: SFP fiber or electric GE interface
- Expander #4** supported by: NTS-5000 only  
LAN5: RJ45 electric GE interface  
LAN6: SFP fiber or electric GE interface

Each of LAN3-LAN10 (Expander 1-4) network interface supports own: IP, MASK and GATEWAY. If GENTEWAY is not used please keep field empty (filled by zero). Each of Expander 1-4 NIC is independent microprocessor MASTER with own CPU, RAM, IP-stack and PTP-stack.

Example IP configuration of Expander #1 (LAN3-LAN4).  
 The LAN3 is labeled ETH  
 The LAN4 is labeled SFP

```

NTS Network Time Server

PTP 1
PTP 2
PTP 3
PTP 4
Exit

Reference time: 2019-03-25 18:03:00 Mode : MASTER
PTP UTC time : 2019-03-25 18:03:00 Link ETH : Down
PTP TAI time : 2019-03-25 18:03:37 Link SFP : Disabled
PTP UTC offset: 37 sec MAC ETH : fc:af:6a:ff:66:7c
Clk states : FREE MAC SFP : fc:af:6a:ff:66:7d
Clk sync : NO S/N : 026236.5.29151
TOD input : Unstable
PPS input : Unstable
PPS source: UNKNOWN
NTP offset: -163.802 ms

PTP Profile
(*) Default E2E
( ) Default P2P
( ) Tel G.8265.1
( ) Tel G.8275.1
( ) Power C37.238 v1
( ) Power C37.238 v2
( ) Custom

Port
Mechanism (*) E2E
( ) P2P
Protocol (*) UDP
( ) ETH
( ) UDP6
Compatibility (*) Auto
( ) On
( ) Off
timeout 0
Unicast (*) Master
( ) Slave
( ) Disable
Asymetry [sec]
Sync 0
Delay 0
Pdelay 0
Announce 0
Receipt 0
DSCP 0
SNTP server [x] enable
( ) Unicast
( ) Multicast
( ) Broadcast
(*) Mixed
Poll 0

Network
IP eth 10.112.0.254
Netmask 255.255.255.0
Gateway 10.112.0.1
IP sfp 192.168.1.211
Netmask 255.255.255.0
Gateway 0.0.0.0
IP node
Mode (*) ETH
( ) SFP
( ) ETH & SFP

Clock
Description NTSPTP1
Type (*) Ordinary
( ) boundary
Two step [x] enable
Slave only [ ] enable
Priority 1 128
Priority 2 128
Domain 0
Time
UTC offset [ ] enable
seconds 0
Quality
Class 6
Accuracy 33
Variance 65535

<Apply> <Save> <Cancel>

Clepsydra Time Systems (2016)
Esc/F12 - Cancel | F2 - Firmware upgrade | F5 - Apply | F10 - Save
  
```

Expander #1 configuration view (SSH setup via LAN1 or LAN2)

# 10. QUICK INFO – Troubleshooting

## Problems with PC communication to server.

If any problem with LAN1 or LAN2, the software SETUP can be executed via **RS232** (front panel)  
Always keep note, only one interface (LAN1, LAN2, rs232) can be exclusively used for SETUP in time.

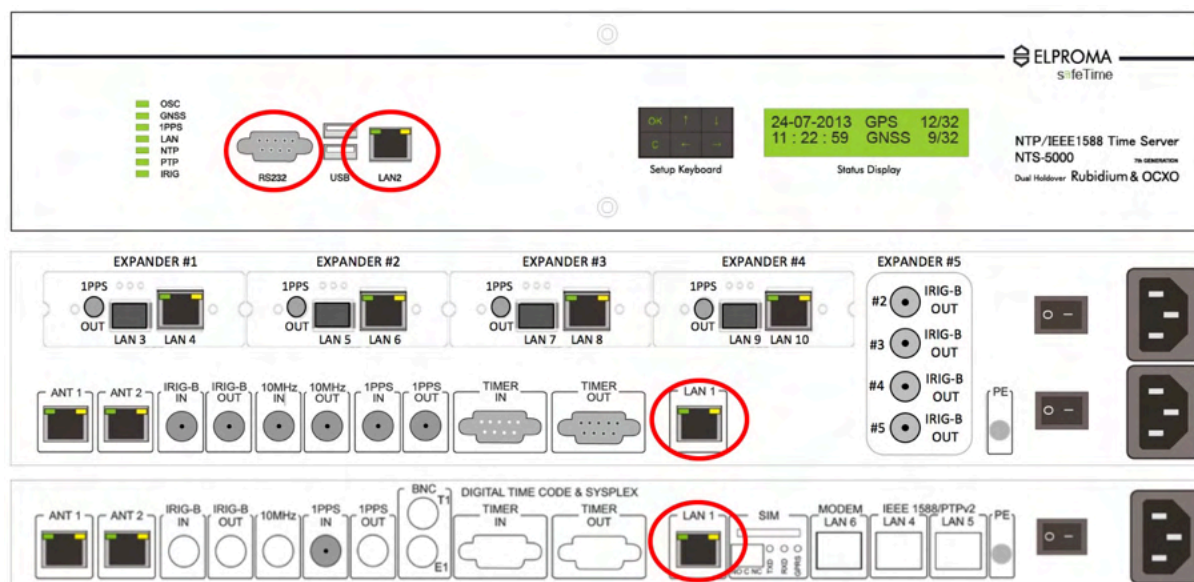

Only front panel **RS232 & LAN2** or back panel **LAN1** can be used for text mode terminal **SETUP** configuration.

For RS232 terminal communication, please use cross serial cable and connect it to DSUB-9 front panel connector. Please use on PC following serial configuration set to: **9600,8,1,n**.

**WARNING!** You cannot access SETUP using LAN3 - LAN10 (NTS-5000 and LITE only. Expander 1-4).

**Note!** For Microsoft Windows operating system you might like to choose **PUTTY** software available **FREE** to download from: <http://www.putty.org>. To ensure displaying correct character set, please choose in configuration Category->Window->Translation->Remote Character Set the correct setting to your region. In case e.g. of Central European the correct options will be Win1250 (Central European)

The factory default setting is:

**User name: admin**  
**Password: 12345**

### Problems with 2 antennas connected to server (very important)

If using 2x redundant antennas simultaneously, please set 1<sup>st</sup> to BIN mode (DIR-A sub-menu), and 2<sup>nd</sup> to NMEA text mode (DIR-B sub-menu). Otherwise both antennas can be marked 'x' (FALSE TICKER).

### Tracing visibility of satellite signals

To trace satellites signals, please choose MISC and then GPS option. You should be able to observe at least min. 5 satellites otherwise synchronization to GNSS is not pending and server is FREE-RUN.

```
LAN1
LAN2
VLAN
ROUTING
SYSLOG
SNMP
NTP
DATE/TIME
TIMEZONE
AUTH
RADIUS
DNS
*MISC
Exit

UPGRADE -- try firmware upgrade by USB
GPS     -- show GPS status data
ANT A DIR -- antenna A socket direction (I)
ANT B DIR -- antenna B socket direction (I)
NTPQ    -- console ntpq
Return  -- return to main menu

UPGRADE GPS DIR-A DIR-B NTPQ Return
```

```
LAN1
LAN2
VLAN
ROUTING
SYSLOG
SNMP
NTP
DATE/TIME
TIMEZONE
AUTH
RADIUS
DNS
*MISC
Exit

ANTENNA A GPS 6/10 GLN 0/0
TIME VALID, LEAP NO WARNING
GPS SNR 50 00 46 00 38 44 00 00 39 29 00 00
GLN SNR 00 00 00 00 00 00 00 00 00 00 00 00
Lat = 52.346390 N 52°20'47.00"
Long = 20.892353 E 20°53'32.47"
Alt = 89.00

ANTENNA B NOT CONNECTED
```

If GNSS connection is OK, you should see the screen similar to above. If values of signal strength are zero (00) it means GNSS receiver is not receiving signals. In such case please recheck antenna installation and restart (power OFF-ON) server. Once the strength is no-zero value, it is good to select



NTPQ menu and trace NTP internal synchronization. The description of using NTPQ is not a part of this manual and can be find at site [www.ntp.org](http://www.ntp.org)

<pre> LAN1 LAN2 VLAN ROUTING SYSLOG SNMP NTP DATE/TIME TIMEZONE AUTH RADIUS DNS *MISC Exit         </pre>	<pre> UPGRADE -- try firmware upgrade by USB GPS     -- show GPS status data ANT A DIR -- antenna A socket direction (I) ANT B DIR -- antenna B socket direction (I) NTPQ    -- console ntpq Return  -- return to main menu         </pre> <hr style="border: 0.5px solid black;"/> <pre> UPGRADE GPS DIR-A DIR-B NTPQ Return         </pre>
---	--

```

[ntpq> pe
  remote          refid      st t when poll reach  delay  offset  jitter
=====
xGPS_NMEA(0)     .ANT1.      0 1  7  8 377  0.000  -0.008  0.004
oGPS_NMEA(1)     .ANT2.      0 1  5  8 377  0.000   0.001  0.004
*SHM(0)          .OCXO.      0 1  6  8 377  0.000   0.011  0.004
PPS(2)          .EXT.       0 1  -  8  0  0.000   0.000  0.000
SHM(4)          .IRIG.      0 1  -  8  0  0.000   0.000  0.000
[ntpq> rv
associd=0 status=0415 leap_none, sync_uhf_radio, 1 event, clock_sync,
version="ntpd 4.2.8p10@1.3728-o Thu May 18 21:16:59 UTC 2017 (2)",
processor="i386", system="UNIX", leap=00, stratum=1, precision=-18,
rootdelay=0.000, rootdisp=1.105, refid=ANT2,
reftime=dd5ff144.a1dd82f2 Sun, Sep 10 2017 19:13:40.632,
clock=dd5ff14b.be022b81 Sun, Sep 10 2017 19:13:47.742, peer=63009, tc=3,
mintc=3, offset=0.001099, frequency=49.815, sys_jitter=0.003815,
clk_jitter=0.004, clk_wander=0.000, tai=37, leapsec=201701010000,
expire=201706280000, ELPROMA=NTS-4000/20161020/SN14418028
ntpq>
    
```

*Tracing time ref. resources inside NTS time server using built-in NTPq diagnostic*

Normal operation of server (when antennas are installed correct, and the receiver is decoding satellite signals fine) the REACH column of NTPQ should not be zero (0). After several minutes of server being uptime this octal value should REACH number 377. This means GNSS data is correct and the server synchronization is pending to GNSS. The synchronization is confirmed by displaying displays '\*' or 'o' located at the very first column of a table. Once it is done, server starts to synchronize local oscillators. It will take another 10-20min to synchronize first OCXO (NTS-4000), and another 10-20 minutes to do PLL on RUBIDIUM (Rb) oscillator (NTS-5000 only). A HOLDOVER oscillator is ready and locked (PLL/FLL) to GNSS once NTPQ "pe" command displays '\*', 'o', '+' or '-' character at the very first column of a table. This means oscillator belongs to group of NTP Truechimers (time ref. candidate).

# 11. QUICK INFO – Updating Firmware

NTS-x000 firmware update can arrive neither on USB memory or it can be downloaded from cryptographically protected cloud. For security reasons firmware updates are not available public web service. You will be informed about new firmware and software patches releases by e-mail. Please ref. to very first chapter “QUICK INFO - About” for details how to register your e-mail and NTS-x000 product.

Below steps informs how to provide firmware update step by step, and using SSH protocols:

1. Prepare USB flash drive with minimum 128Mb free space (FAT32 formatted)
2. Download **nts345.v-yymmdd.img** file from cloud and copy it to root folder of USB flash drive
3. Plug-in to NTS-x000 front panel USB connector (upper or lower)
4. Login to NTS-x000 using **LAN1** or **LAN2** and SSH protocol
5. Go to **MISC** menu, and select **UPGRADE** submenu using arrow-keys
6. Follow information on the screen (do not interrupt upgrading process)
7. Once firmware update is done, please **EXIT** and **LOGOUT**
8. **VERY IMPORTANT!** Clear your web browser history and delete all cookies. Restart web broser.
9. Restart your timeserver (power OFF-ON) or make hardware reset
10. The new firmware version should be displayed on LCD after restarting

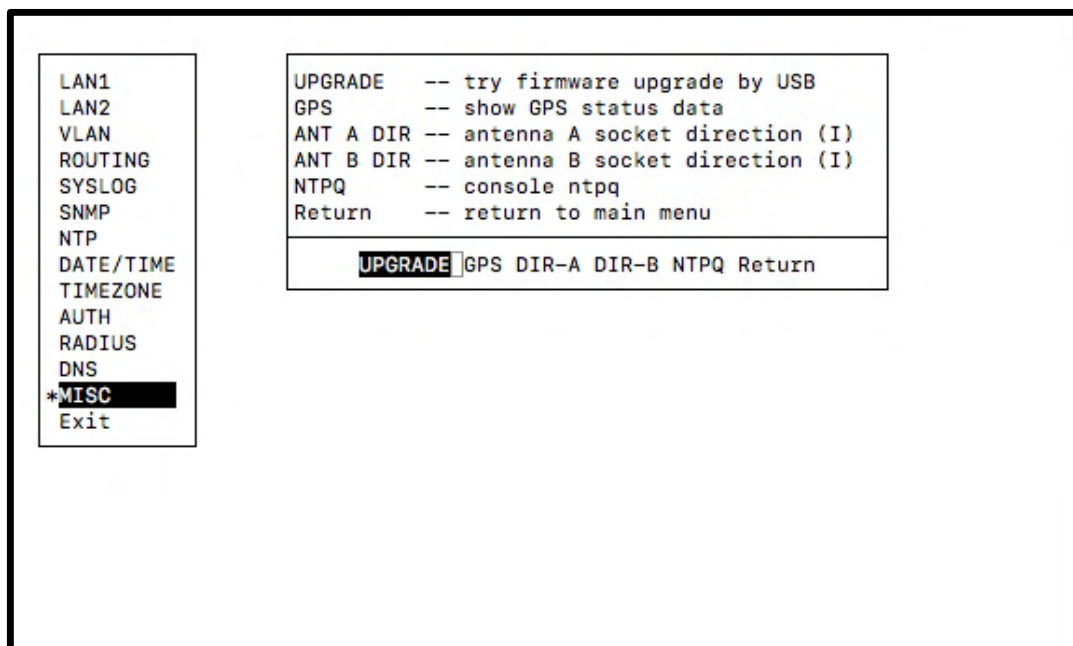

Server SETUP via SSH (display view)

<b>Firmware release</b> NTS-5000      05/04/2019
---

Note!

The firmware upgrades can be also provided via web browser GUI setup (www). For more details please ref. to SOFTWARE SETUP chapter.

## 12. QUICK INFO – Updating Expanders 1-4

Disclaimer. This chapter is only for NTS-5000 and NTS-5000LITE users who have purchased product equipped with special EXPANDER 1-4 network cards. The strong cybersecurity nature of NTS-5000 forces all (max. 4) EXPANDER cards to be physically isolated (no TCP/IP communication) from each other and from main unit. Therefore the site effect of isolation is fact that also EXPANDER firmware updates need to be done on different and very special way, described below.

Before upgrading any Expander 1-4 card, please ensure your main unit has been successfully updated to latest firmware version.

### IMPORTANT NOTE!

To update firmware of Expander #1 network interface card you need to connect directly LAN2 of main server to LAN3 (SFP) or LAN4 (RJ45) first. Connection must be done directly. No intermedia Ethernet converters, switches, routers are allowed. For Expander #2 use connection LAN2->LAN6, Expander #3 LAN2->LAN8, Expander #4 LAN2->LAN10. Detected Expander 1-4 cards will appear in SSH setup:

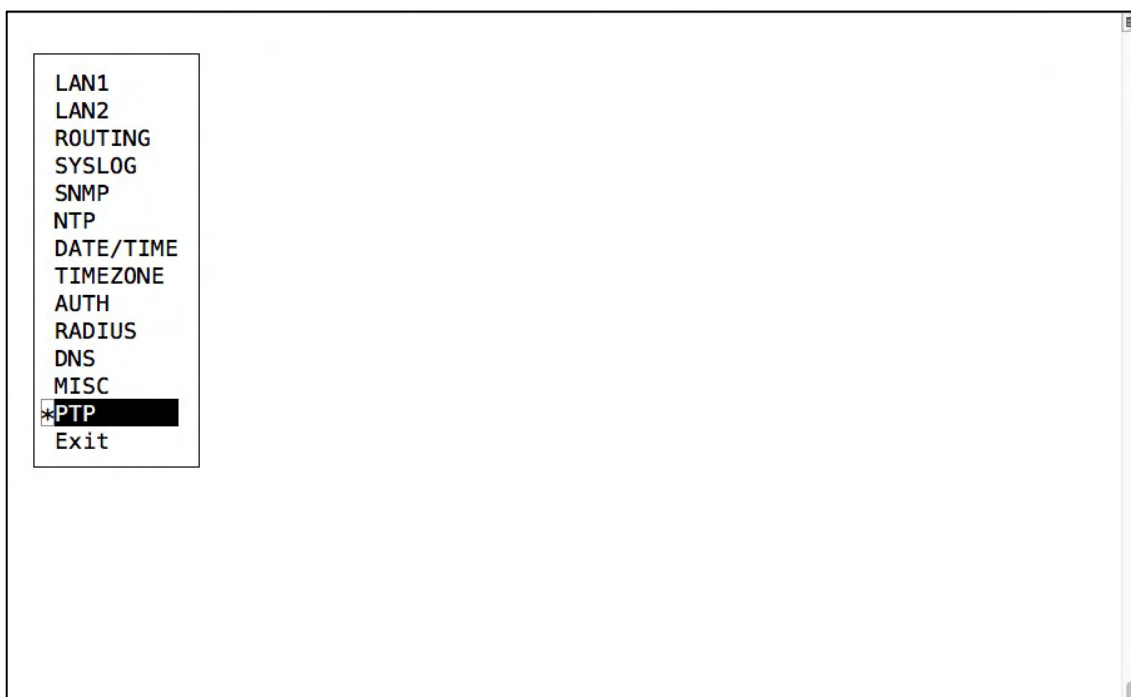
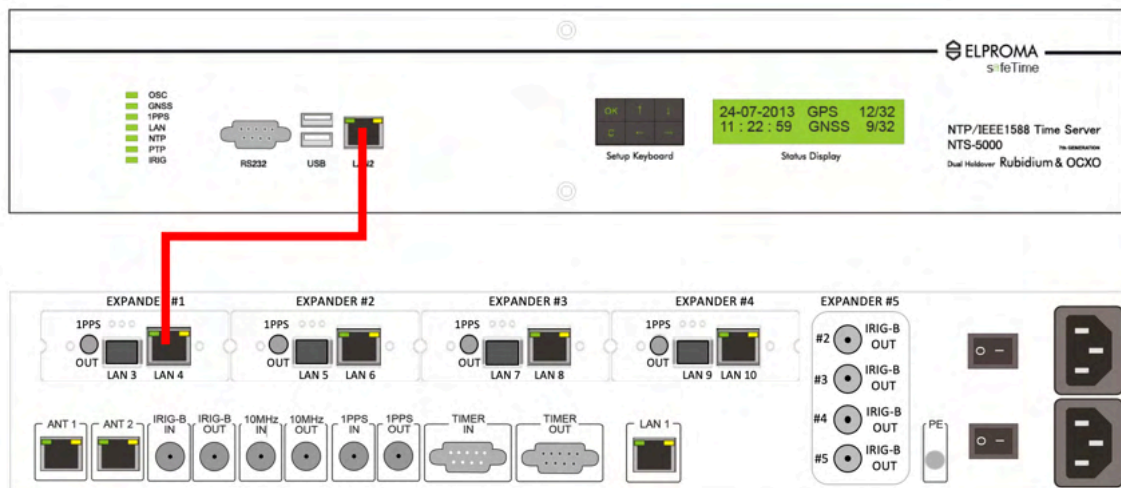

Please check S/N field first.

**S/N: 027806.5.29151**

- no firmware update available

**S/N: 027806.5.29151 (UPG)**

- firmware update is available

If there is "(UPG)" flag just after the serial number. This indicates fact that your last NTS5000 main firmware update has included also extra sub0firmware update to be load to Expander #1. Please press F2 to start firmware upload.

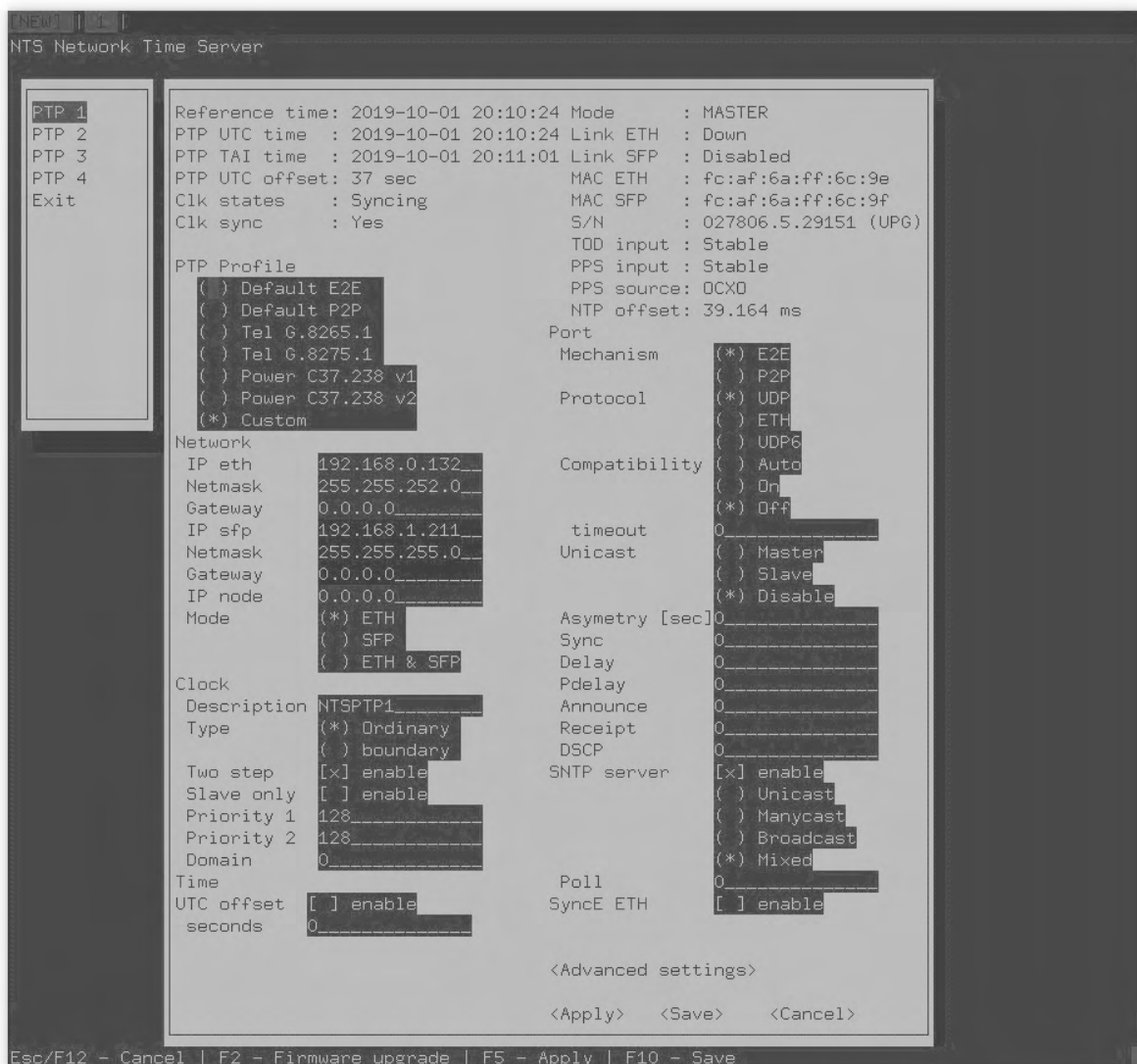

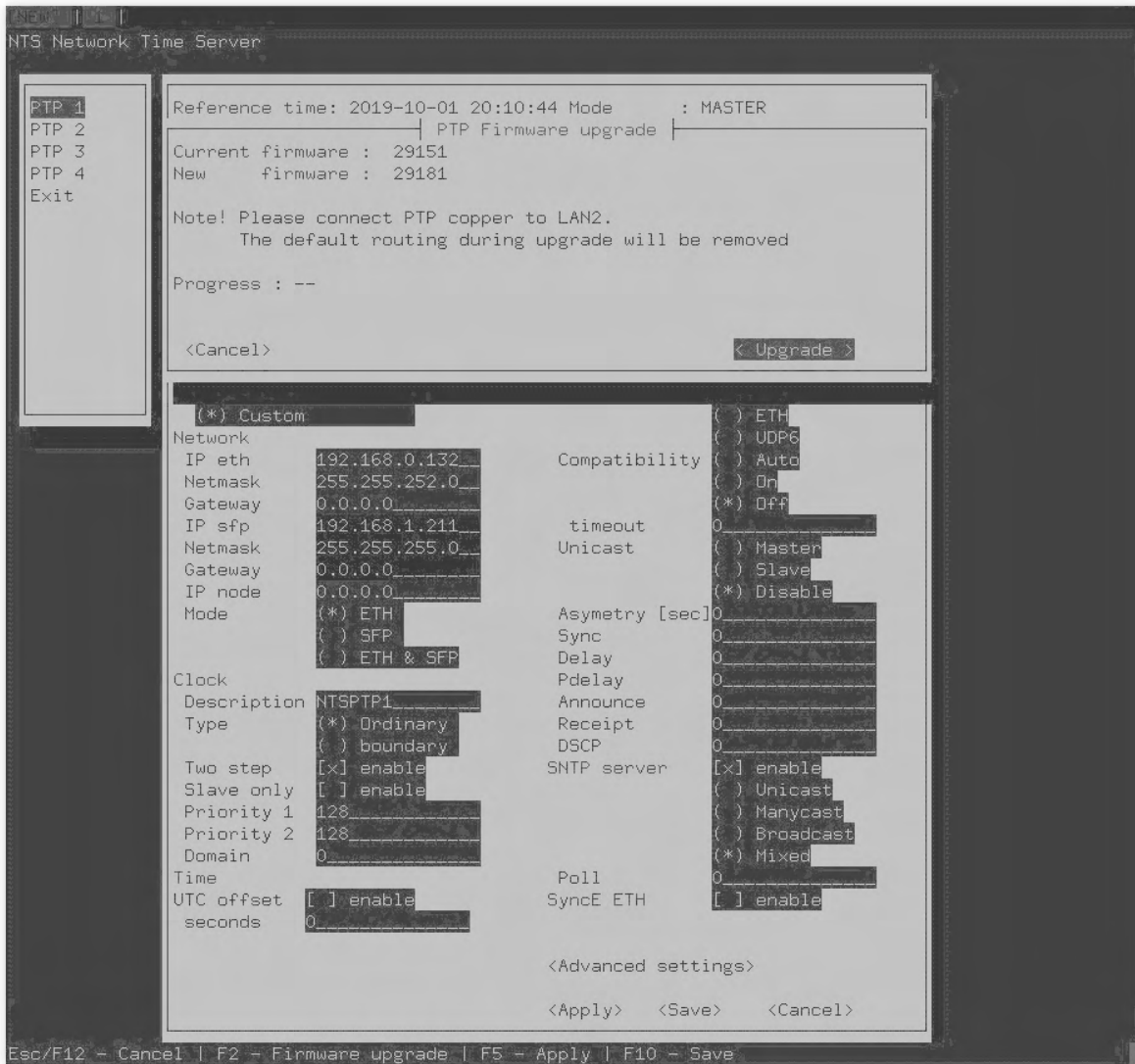

How to read EXPANDER firmware rev. number.

There are 3 segments separated by colon e.g. S/N: 027806.5.29151 (UPG), so the constructor of firmware is **X.Y. Z** where:

- X** – is physical S/M of Expander module (027806)
- Y**- FPGA hardware type (4-M64, 5-M68, 6-M88, 7-WR PTP2.1)
- Z** – current rev. number of expander software firmware (29151)

Please repeat above steps for each Expander #card separately. Always use LAN2 of main unit to distribute firmware to specific expander.

# 13. QUICK INFO – Restoring Factory Defaults



Front panel keyboard view

### Restoring Factory Defaults

Press & hold (at the same time) “OK” and “C” buttons, until following below message will be displayed on LCD. Press “OK” one more time to RESET product and RESTORE factory defaults, or press “C” to abort the operation. Following below message will be displaced on LCD and needs to be confirmed [OK] “Yes”

Are you sure?  
[OK]-Yes [Cancel]-No

You need to confirm before restoring to factory defaults

Standard LAN1-LAN2 defaults:

LAN1: 10.0.0.210      MASK: 255.255.0.0      GATEWAY: 10.0.0.1  
LAN2: 192.168.0.210      MASK: 255.255.255.0      GATEWAY: 192.168.0.1

Optional LAN3-LAN10 (NTS-5000 only) component settings:

LAN3: 192.168.3.210      MASK: 255.255.255.0      GATEWAY: <no value>  
LAN4: 192.168.4.210      MASK: 255.255.255.0      GATEWAY: <no value>  
LAN5: 192.168.5.210      MASK: 255.255.255.0      GATEWAY: <no value>  
LAN6: 192.168.6.210      MASK: 255.255.255.0      GATEWAY: <no value>  
LAN7: 192.168.7.210      MASK: 255.255.255.0      GATEWAY: <no value>  
LAN8: 192.168.8.210      MASK: 255.255.255.0      GATEWAY: <no value>  
LAN9: 192.168.9.210      MASK: 255.255.255.0      GATEWAY: <no value>  
LAN10: 192.168.10.210      MASK: 255.255.255.0      GATEWAY: <no value>

Factory default user and password:

Username: **admin**  
Password: **12345**

Software SETUP services defaults:

HTTP                      ON  
HTTPS                     ON                      ON  
SSH                        ON  
TELNET                    OFF

Std. ref. time:

**GNSS** (GPS/GLONASS only)

Interfaces:	Defaults	Available	NTS-x000 modes	rs485
Ant1 (Antenna “A”)	INPUT	INPUT	(all)	RJ45
		OUTPUT	(NTS-4000 & NTS-5000 only)	RJ45
		DISABLE	(NTS-4000 & NTS-5000 only)	
Ant2 (Antenna “B”)	INPUT	INPUT	(all)	RJ45
		OUTPUT	(NTS-4000 & NTS-5000 only)	RJ45
		DISABLE	(NTS-4000 & NTS-5000 only)	

**Note!** After restoring to factory defaults, please clear your web browser history and delete cookies.

•

**HARDWARE**

# **User Manual**



# 14. Hardware Of NTS-x000 Family

## IMPORTANT NOTE!

Before reading this part of manual please read Quick Manual "Configure in 5 minutes" first. Some fundamental basics of setup operations are described earlier and not repeated here.

The NTS time servers has all very similar front panel view. All product are available under ELPROMA or branded to CLEPSYDRA brand. Below picture present all family of NTS time servers.



ELPROMA NTS family of time servers (from top: NTS-3000, NTS-4000, NTS-5000LITE and NTS-5000 Rubidium)

There is 2x20 characters LCD *Status Display* (green colour), 6-key mechanical keyboard for quick setup, RS232 (DSUB-9 male) connector for direct SETUP, 2xUSB2.0 interface for firmware upgrade etc. There is LAN2 connector located on the front panel too. It contains 2x LEDs: green - indicates cable connection, yellow - flashes while data is being transmitted.

The front panel view of NTS time server is:

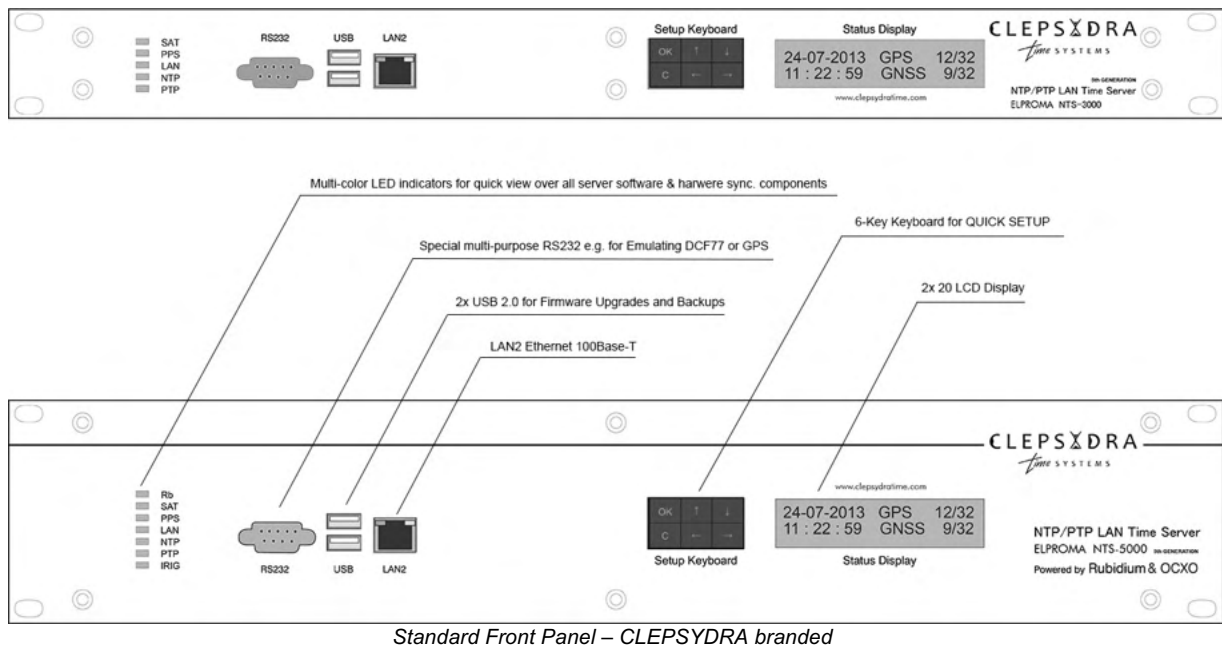

The back panel of NTS is organized on way there are several I/O referential time sections:

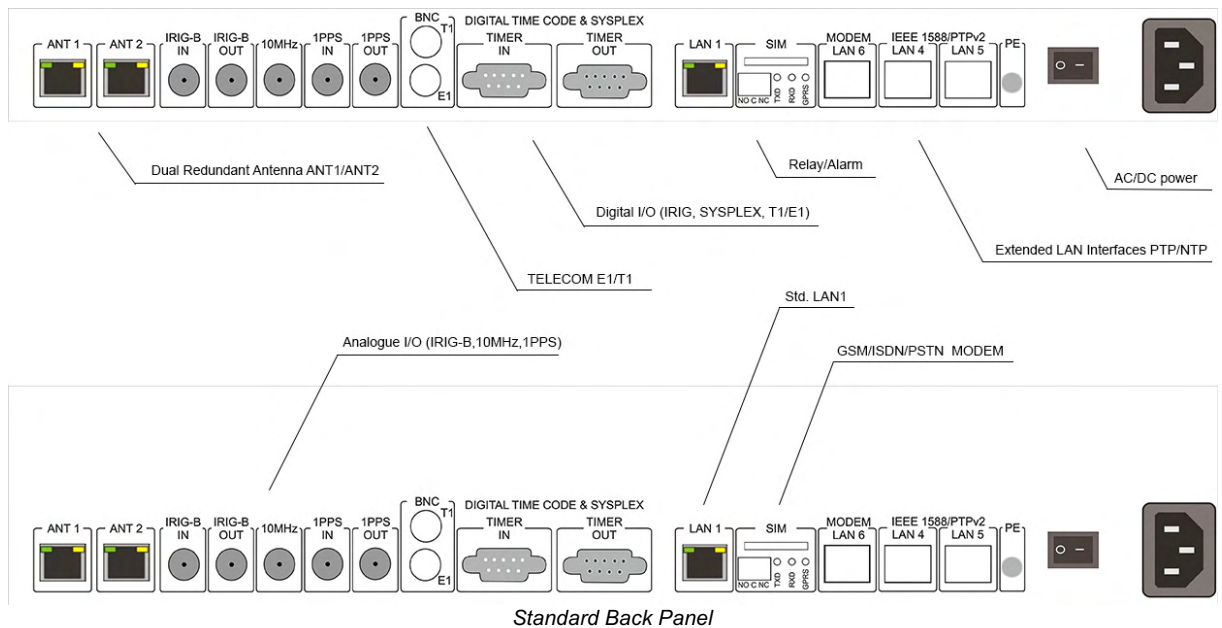

# 15. Hardware of NTS-3000 (Standard Version)



NTS-3000 (standard) Front Panel

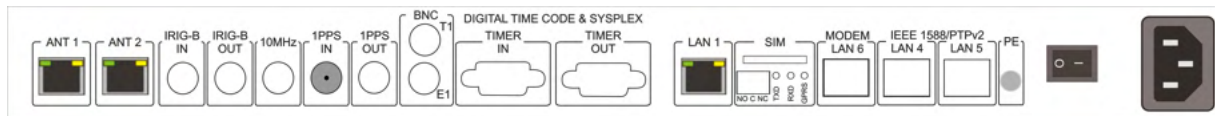

NTS-3000 (standard) Back Panel

Table describe connectors it's availability and related into it functions:

Name	Connector	Standard	Purpose	Availability
Antenna (A)	RJ-45	RS-485	Antenna connector (main antenna)	+
Antenna (B)	RJ-45	RS-485	Antenna connector (backup antenna)	+
IRIG-B IN*	BNC	IRIG-B	IRIG-B source signal (optionally)	-
IRIG-OUT*	BNC	IRIG-B	IRIG-B output signal (optionally)	-
10 MHz	BNC	10MHz	10 MHz output reference signal	-
1 PPS IN	BNC	1pps	1 PPS (pulse per second) source signal	+
1 PPS OUT	BNC	1pps	1 PPS (pulse per second) output signal	-
TIMER IN	DSUB9	RS-232	2xPPS (pulse per second) input signal	-
TIMER OUT	DSUB9	Various	Extra feature (not available yet)	-
LAN1	RJ-45	TCP/IP	Local Area Network (back panel)	+
LAN2	RJ-45	TCP/IP	Local Area Network (front panel)	+
RS-232	DSUB9	RS-232	For technical and service purpose	+
USB	KUSB	USB	For technical and service purpose	+



NTS-3000 (standard) Back Panel picture

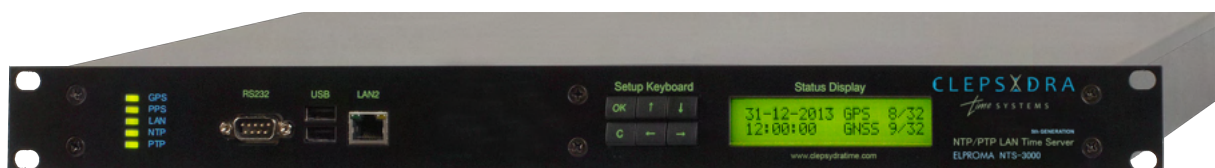

NTS-3000 (standard) Front Panel picture

# 16. Hardware of NTS-4000 OCXO (Standard Version)



NTS-4000 OCXO (Standard Version) 1U rack 19 mount Front Panel

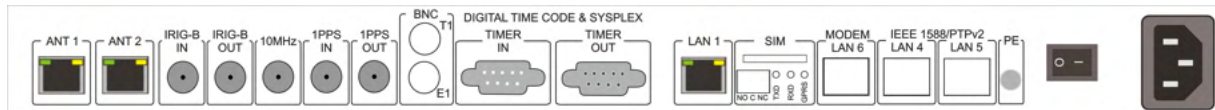

NTS-4000 OCXO (Standard Version) Back Pane

Table describe connectors it's availability and related into it functions:

Name	Connector	Standard	Purpose	Availability
Antenna (A)	RJ-45	RS-485	Antenna connector (main antenna)	+
Antenna (B)	RJ-45	RS-485	Antenna connector (backup antenna)	+
IRIG-B IN	BNC	IRIG-B	<RESERVED> CONTACT FACTORY	+
IRIG-OUT	BNC	IRIG-B	IRIG-B output signal (optionally)	+
10 MHz	BNC	10MHz	10 MHz output reference signal	+
1 PPS IN	BNC	1pps	1 PPS (pulse per second) source signal	+
1 PPS OUT	BNC	1pps	1 PPS (pulse per second) output signal	+
TIMER IN	DSUB9	RS-232	2xPPS (pulse per second) input signal	+
TIMER OUT	DSUB9	Various	Extra feature (not available yet)	+
LAN1	RJ-45	TCP/IP	Local Area Network (back panel)	+
LAN2	RJ-45	TCP/IP	Local Area Network (front panel)	+
RS-232	DSUB9	RS-232	For technical and service purpose	+
USB	KUSB	USB	For technical and service purpose	+



NTS-4000 OCXO (Standard Version) Back Panel picture

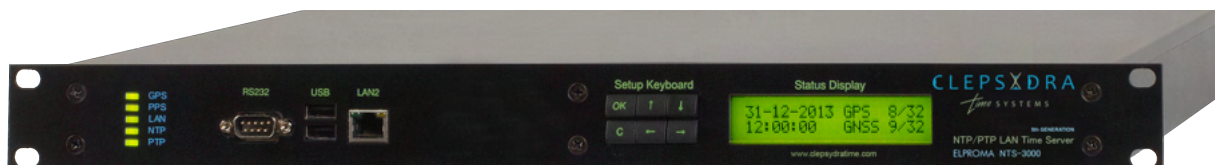

NTS-4000 (Standard Version) Front Panel picture

# 17. Hardware of NTS-5000 Rb & OCXO (Standard Version)

The difference between NTS-5000 and NTS-5000 is Rubidium quantum oscillator only. NTS-5000 is Rubidium & OCXO holdover advanced server. NTS-5000 LITE is OCXO driven only. Product delivers UTC time directly to network (max. 10x LAN) using PTP IEEE1588 and NTP. Interfaces LAN1 & LAN2 are 10/100Mbps. Ports LAN3-LAN10 are optional GE Ethernet GRANMASTER PTP/IEEE1588 with hardware timestamping (see "Extended version" next page).

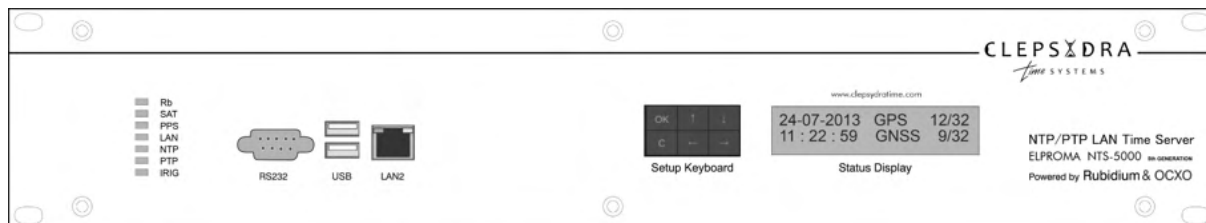

NTS-5000 RUBIDIUM+OCXO (Standard Version) 2U rack'19 mount Front Panel

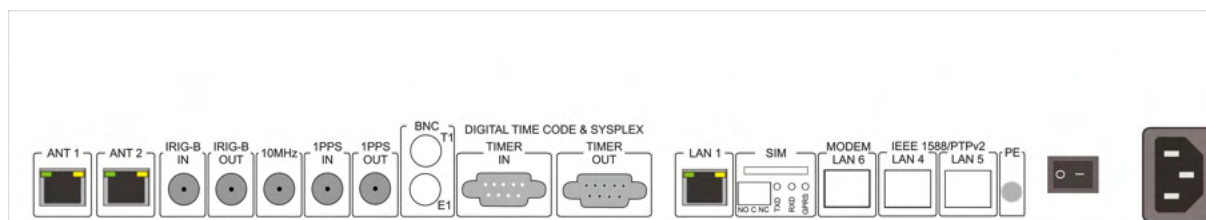

NTS-5000 RUBIDIUM+OCXO (Standard Version) 2U rack'19 mount Back Panel

Table describe connectors it's availability and related into it functions:

Name	Connector	Standard	Purpose	Availability
Antenna (A)	RJ-45	RS-485	Antenna connector (main antenna)	+
Antenna (B)	RJ-45	RS-485	Antenna connector (backup antenna)	+
IRIG-B IN	BNC	IRIG-B	IRIG-B source signal (optionally)	+
IRIG-OUT	BNC	IRIG-B	IRIG-B output signal (optionally)	+
10 MHz	BNC	10MHz	10 MHz output reference signal	+
1 PPS IN	BNC	1pps	1 PPS (pulse per second) source signal	+
1 PPS OUT	BNC	1pps	1 PPS (pulse per second) output signal	+
TIMER IN	DSUB9	RS-232	2xPPS (pulse per second) input signal	+
TIMER OUT	DSUB9	Various	Extra feature (not available yet)	+
LAN1	RJ-45	TCP/IP	Local Area Network (back panel)	+
LAN2	RJ-45	TCP/IP	Local Area Network (front panel)	+
RS-232	DSUB9	RS-232	For technical and service purpose	+
USB	KUSB	USB	For technical and service purpose	+



NTS-5000 RUBIDIUM+OCXO (Standard Version) 2U rack'19 mount Front Panel



NTS-5000 RUBIDIUM+OCXO (Standard Version) 2U rack'19 mount Back Panel

## Special Extended Version of NTS-5000

Ports LAN3-LAN10 are optional GE Ethernet (SFT, RJ45). They are available via Extender 1-4 cards. They support hardware timestamping. Each card 1-4 have own private IP stack. Cards are 100% isolated each other using one-way analogue synchronization signals. Server is equipped with 2 independent GNSS receiver inputs (ANT1 & 2). Each can support independent satellite receivers. Built-in RUBIDIUM (NTS-5000LITE is OCXO only) oscillator guarantees time for long period of missing GNSS signals. Both ANT1/ANT2 interfaces can be switched to output mode emulating GNSS NMEA signals with PPS-out. Server can be synchronized to external clocks using 1PPS, IRIG-B inputs, rs232 (ToD). It also provides ref. output time via 1PPS, IRIG-B, rs232, 10MHz, rs232(SYSPLEX, IRIG). NTS-5000 is STRATUM-1 server, PTP/IEEE1588 GRANDMASTER supporting hardware stamps. It offers accuracy better than 200ns (typically 20ns) on PTP LAN3-LAN10 interfaces. Server supports UTC leap second, synchronizes UTC monotonously (jump-free) and can simultaneously serve up to 100,000 NTP clients. NTS-5000 can be also equipped with special ALARM relay module (Expander3), 4x IRIG-B DCLS rs422 (Expander4), 4x IRIG-B AM TTL or Fiber (Expander 5).

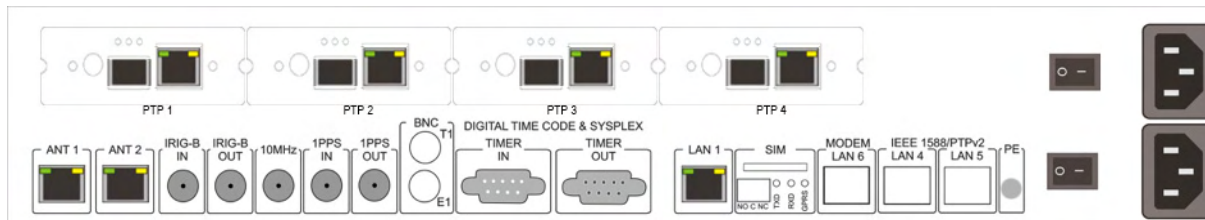

NTS-5000Rb+OCXO w/ extra 4x PTP modules (SFT+RJ45) – all PTP modules works autonomous with own TCP/IP stack  
Double redundant Power Supply, and dual redundant GNSS receivers (ANT1, ANT2)

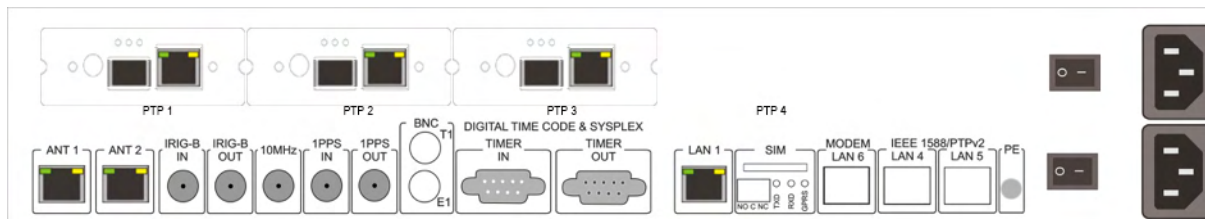

NTS-5000Rb+OCXO w/ extra 3x PTP modules (SFT+RJ45) – all PTP modules works autonomous with own TCP/IP stack  
Double redundant Power Supply, and dual redundant GNSS receivers (ANT1, ANT2)

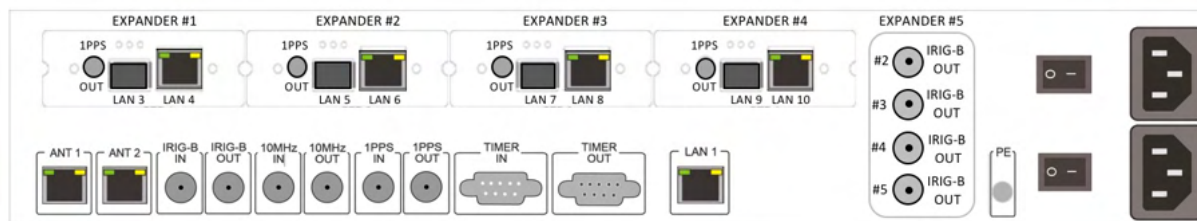

NTS-5000Rb+OCXO w/ extra 4x PTP modules (SFT+RJ45) and IRIG-B x4 (AM) distribution panel

## 18. Hardware of NTS-5000 LITE (OCXO only)

**Note!** The NTS-5000LITE is low cost version of NTS-5000 Rubidium. It is powered by OCXO oscillator only. The difference between NTS-5000 Rubidium and NTS-5000LITE is the RUBIDIUM quantum oscillator only. The Rubidium holdover ensures STRATUM-1 (ITU-I G.811) STRATUM-1 holdover operation with full accuracy for 72 hours. Please follow NTS-5000 to configure your NTS-5000LITE

# 19. Hardware of NTS-5000 Custom

Elproma is able to customize existing NTS-5000 solutions. We are also able to design and manufacture a custom build version of time server that basis on NTS-5000 platform. Below there is example of NTS-5000 device manufactured since 2008 for Air Traffic Control application. Compering to standard product below NTS-5000 supports fiber-optic GNSS antenna and it includes 8x IRIG-B AM distribution channel.

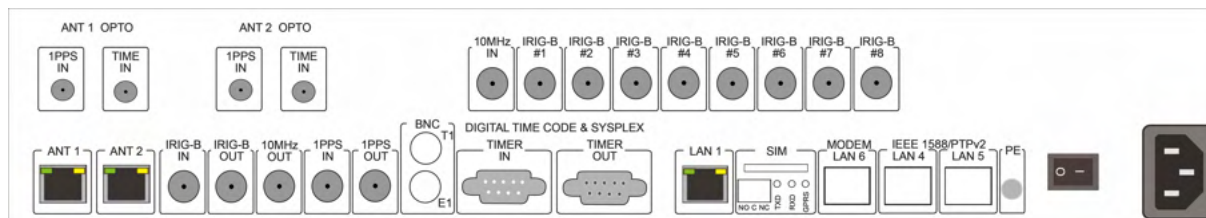

NTS-5000Rb+OCXO w/ 8x IRIG-B distribution panel and 2x FIBER-OPTIC GNSS antenna (back panel)

One of advantages of using IRIG-B AM (analogue modulated) is fact there is no TCP/IP communication that hacker can break into the system. Therefore, frequently the NTS-5000 with 8x IRIRG-B is used to supply ref. time UTC over firewall to internal secured networks. Such connection is requiring 2<sup>nd</sup> level of NTS-5000 working IRIG-B clients. The connection scheme is shown below.

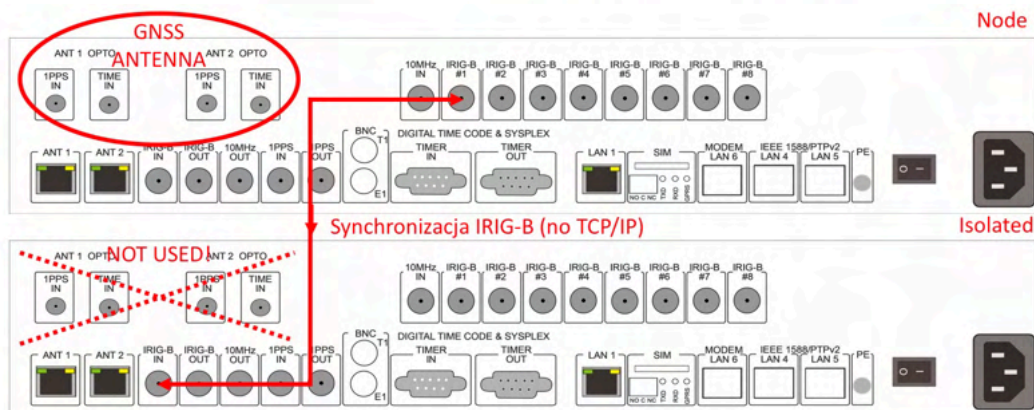
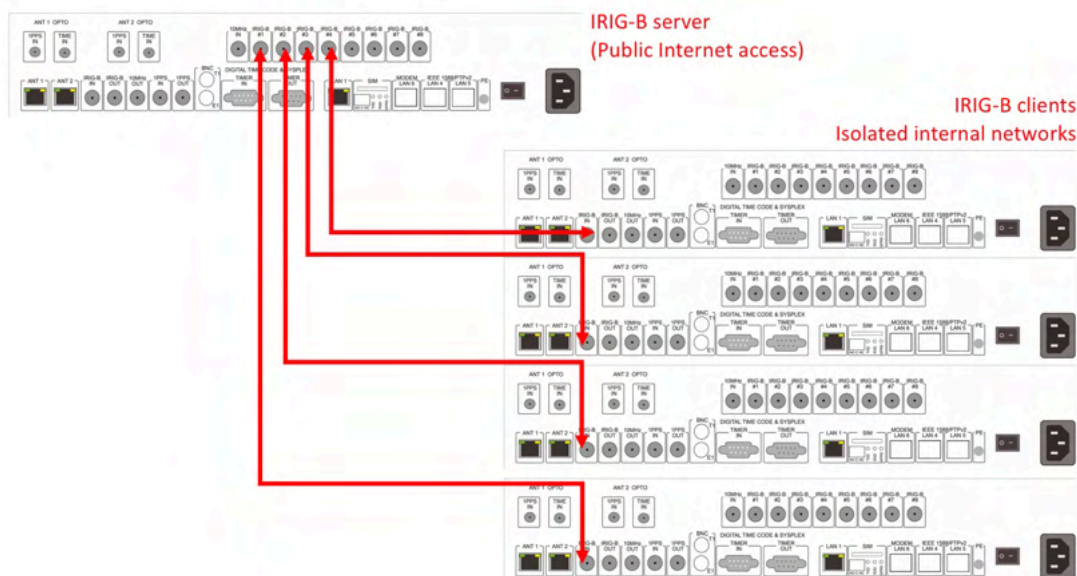



## 20. Hardware of NTS -5000 IRIG-B DCLS

Special configuration of NTS-5000 is dedicated for modern smart-grid systems. The typical unit configuration is:

- Expander #1: 2x PTP IEEE1588 Network Interface w/ hardware stamping  
Supporting: IEEE C37.238 (incl. IEEE 61850-9-3 via C37.238)
- Expander #2: 2x PTP IEEE1588 Network Interface w/ hardware stamping  
Supporting: IEEE C37.238 (incl. IEEE 61850-9-3 via C37.238)
- Expander #3: 4x ALARM RELAYS  
Supporting alarms: SYNC, GNSS, PWR-A, PWR-B
- Expander #4: 4x IRIG-B rs422 DCLS (w/ slide switch 120Ohm termination ON/OFF)  
1x MOSFET PPS/PPM/PPH
- Expander #5: 2x IRIG-B TTL level 5V (w/ slide switch for selecting AM or DCLS)  
2x IRIG-B ST Fiber Optic IRIG-B DCLS

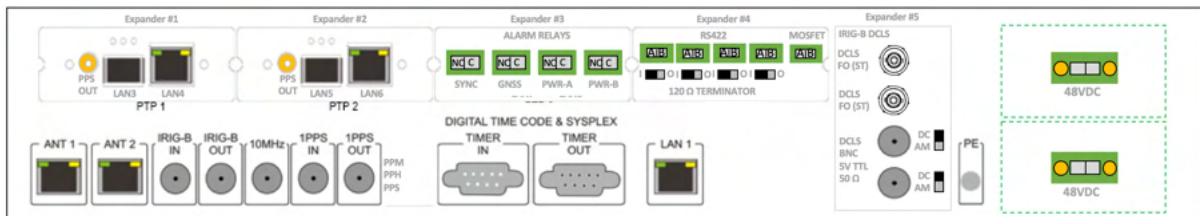

NTS-5000Rb+OCXO w/ 4x ALARM RELAY, 4x RS422 (IRIG-B DCLS), 2x Fiber Optic (IRIG-B DCLS), 2x TTL 5V (IRIG-B)

In above configuration, LAN1 & LAN2 are used for monitoring synchronization facility only. Server receives ref. time from GNSS (ANT-1 and/or ANT-2) and redistribute it via LAN3, LAN4, LAN5, LAN6 GE interfaces using hardware stamping of PTP IEEE1588. Simultaneously it generates all IRIG-B outputs in all available hardware standards too.

Typical IED connections scheme is:

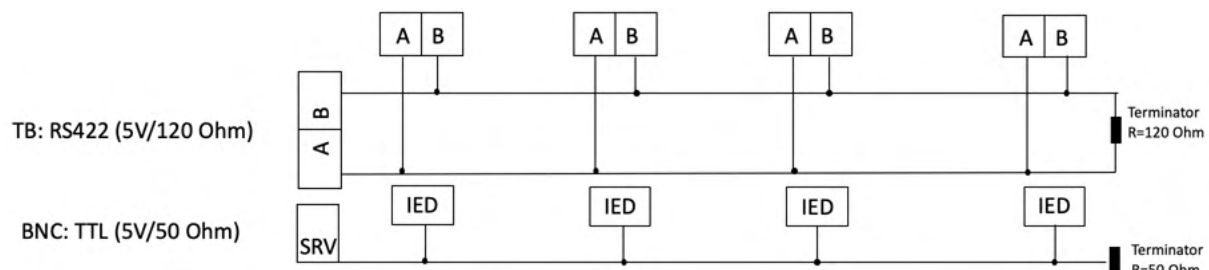

IED connection block scheme: (upper) RS422 w/ 120 termination, (lower) TTL 5V 50 Ohm

# 21. Hardware of NTS – The DSUB9 Interface

Server: NTS-3000, NTS-4000, NTS-5000, NTS-5000LITE, NTS-9000 are equipped with 9pin DSUB9 connectors providing various of hardware synchronization signals.

The pin-out is:

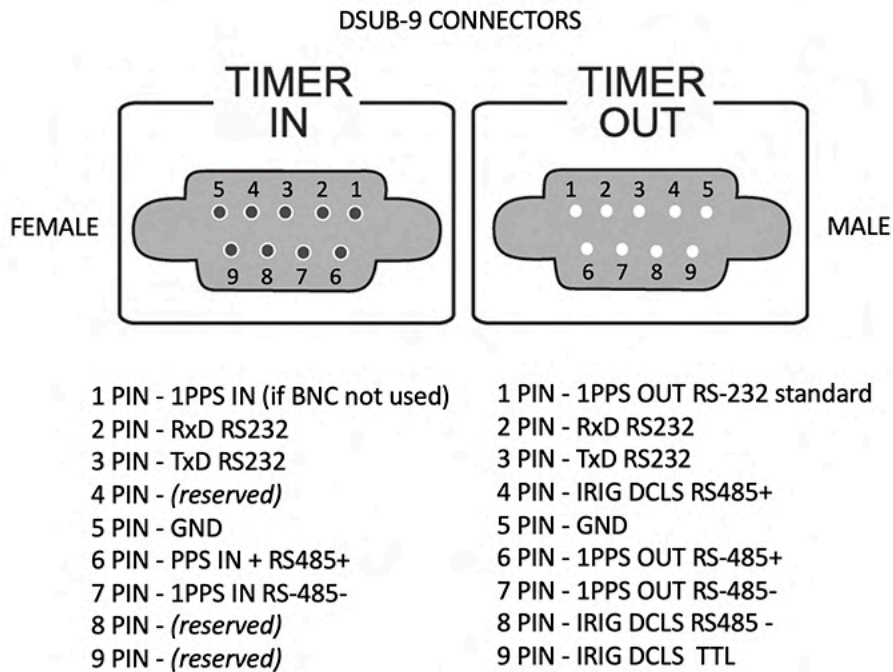

The back panel view with 2x DSUB9 connectors (DIGITAL TIME CODE)

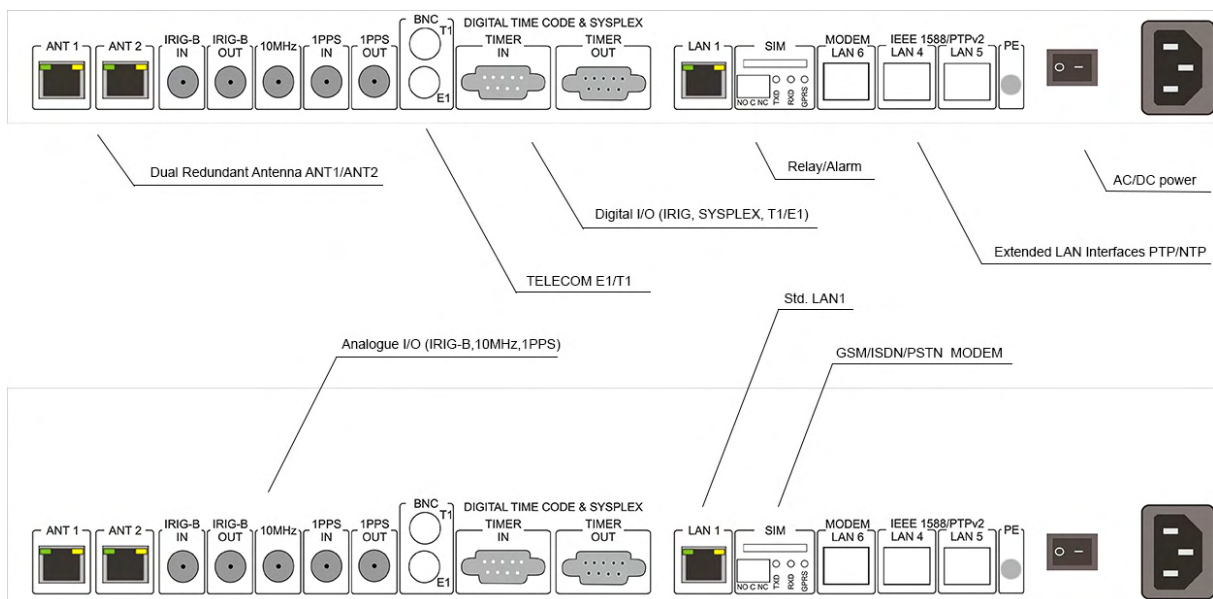

## 22. Hardware of NTS-TC (Time Converter)

Converting UTC/TAI time from IEEE1588 to IRIG-B



NTS-TC (time-converter PTP-2-IRIG) –front panel view



NTS-TC (time-converter PTP-2-IRIG) – back panel view (basic version w/ IRIG-B AM only)



NTS-TC (time-converter PTP-2-IRIG) – back panel view (max. version w/ 4x RS422, 2x FO, 2x BNC TTL 5V AM/DCLS)

The **NTS-time-converter** basis on NTS-5000 hardware platform. It is dedicated for time-code conversions from PTP/IEEE1588 to IRIG and/or (back) from IRIG-B to PTP IEEE1588. Depends on director of signal conversion, the PTP/IEEE1588 operates in Master or Slave PTPv2 mode. Unit can be optionally equipped with Rubidium and OCXO holdover oscillator. In case of failing INPUT time-code, unit can product OUTPUT time base on GNSS or from local holdover oscillator OCXO\*. In case of using GNSS, it is necessary to connect at least one NTS-antenna to NTS-TC. This product is 100% compatible (SETUP level) with NTS-5000 time server therefore, to configure NTS-TC please refer to NTS-5000/NTS-5000LITE.

## 23. Extra Hardware – Redundant PWR Supply

Standard product is delivered with single power supply, but on request each ELPROMA time server can be also equipped with max. 2x redundant power supplies.

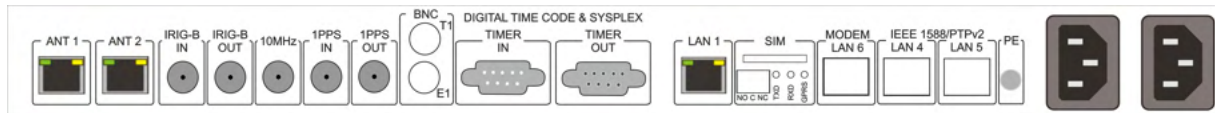

*Custom NTS-3000 or NTS-4000ocxo with redundant A+B dual power supply*

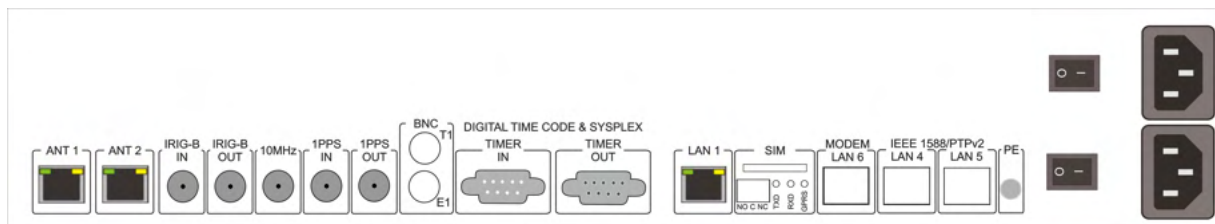

*Custom NTS-5000 Rb & OCXO or NTS-5000LITE with redundant A+B dual power supply*

### WARNING

Elproma time servers can be equipped with various types of AC, DC power supplies supporting different range of voltage. Before using Elproma product please check the type of power supply labelled on the back panel of time server.

**Important note #1!** Standard NTS is delivered by default with power supply 110-230VAC. This power supply also supports DC in range of 120-370VDC.

Following power supplies are available single or dual redundant mode:

20- 70 VDC (max 2A)  
110-230 VAC (max 1A) /default std. /  
120-370 VDC (max 1A)

**Important note #2!** The dual redundant power supply needs to be ordered together with a new NTS product. It is not possible to update NTS later on adding 2<sup>nd</sup> power supply.

# 24. Extra Hardware – Connecting to Cesium

(Based on cesium Model 4400/4500 with 10Mhz connection)

Any NTS family time server can work with external Cesium primary reference of time or frequency. Using external atomic Cesium (Cs) clocks improves holdover operation ensuring server robust frequency stability and high accuracy of synchronization. Depends on type of available connectivity this can be limited to synchronization of frequency (PPS, 10MHz) only or both phase & frequency (ToD + PPS) Synchronizing UTC (TAI) phase and frequency requires special version of NTS product to support direct phase. This chapter describes a connectivity of NTS to frequency reference only – the one that is supported by standard product supporting PPS, or special customized one supporting 10MHz input.

**Important note!** Using Cs frequency ref. is requiring at least one GNSS antenna (NTS-antenna) to be connected to NTS. This is important because a time server needs initial timestamp (ToD – a Time of a Day) information to operate UTC or TAI time scale. The UTC (TAI) can be also initialized from remote NTP server using Network Time Protocol.

**Connecting cesium clock using frequency ref. 10MHz  
(standard product support PPS-input only)**

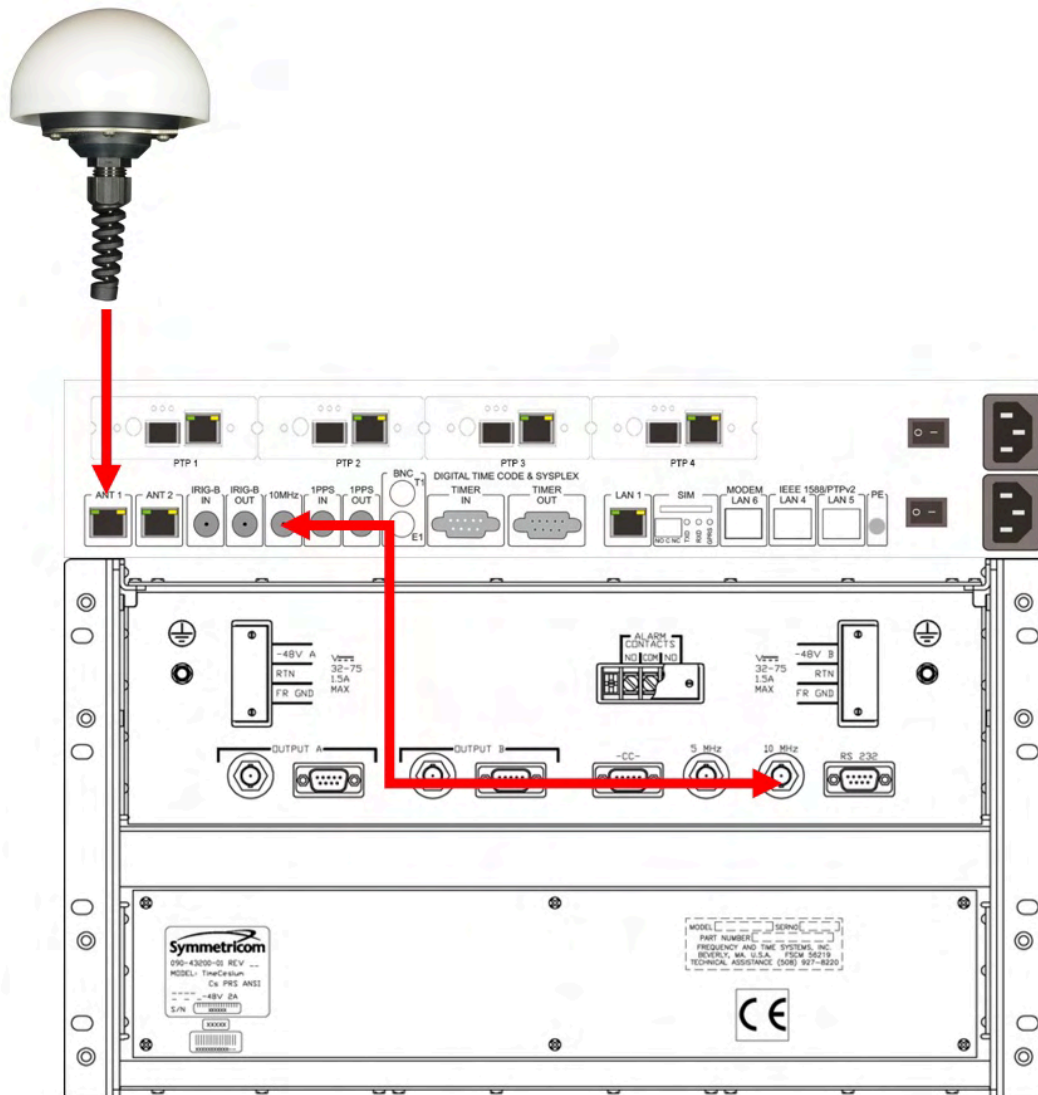

Connecting 10MHz cesium 4400/4500 frequency reference to NTS-5000 input. The same solution can base on 1PPS too.

## 25. Extra Hardware – Connecting To 5071A

(Based on cesium Model 5071 supporting PPS alone or PPS+ToD via rs232 connection)

The 5071A Cesium clock support is available at NTS series since year 2006. Early time this functionality was available for model NTS3000 only. Later it was included to NTS-4000 too. Since 2019, all Elproma NTS series (NTS-3000, NTS-4000, NTS-5000) can support 5071A Cesium atomic clocks. The 5071A connectivity can be set using 1 of following 2 schemes:

### Scheme #1 (Frequency PPS from Cesium only)

NTS-3000, NTS-4000, NTS-5000 uses only frequency reference 1PPS (BNC) from 5071A. The initial ToD (date & time – the UTC phase) is provided from GPS. This solution is requiring NTS-antenna to be connected to NTS time server. The 5071A is used only as a frequency reference and therefore it does not need to be synchronized to UTC.

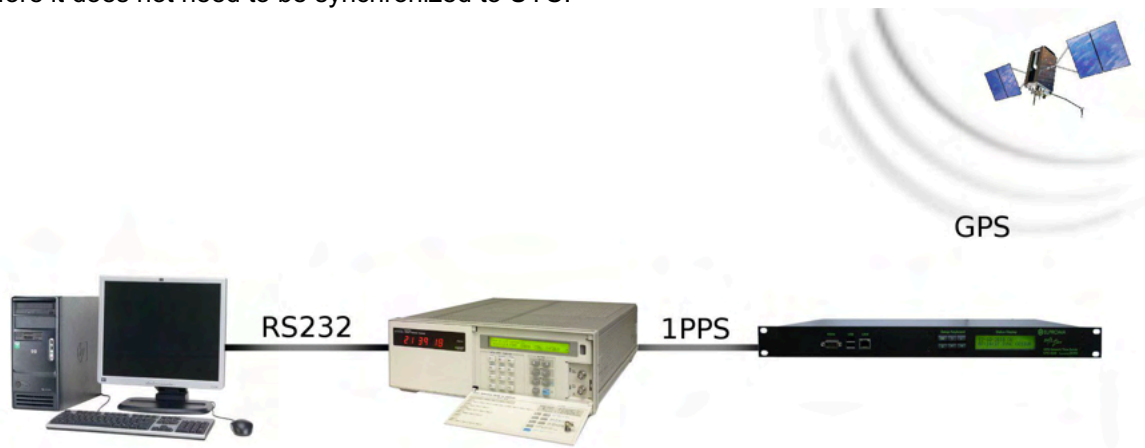

### Scheme #2 (Time & Frequency from Cesium)

NTS-3000, NTS-4000, NTS-5000 are using both 1PPS (BNC) + ToD(rs232) from 5071A. In this connectivity 5071A needs to ensure both UTC time & frequency reference, therefore NTS does not need to be equipped with (GPS) NTS-antenna. You will need to purchase special software firmware licence that enables such connectivity. In case of time server NTS-5000 the product and a license are well known as one bundle product id. **NTS-9000**. In case of EU market this can include 5071 Cesium too.



**NOTE!** In Scheme #2 the NTS time server is 100% transparent for PC telemetry dataflow going from/to 5071A via rs232 interface. Typically, PC is used to run Cesium beam monitoring software.

# Ad. Scheme #1 5071A connectivity (only frequency 1PPS from Cesium)

The 1PPS alone connection is requiring at least one GNSS antenna (NTS-antenna) or another remote NTP server to provide initial ToD timestamp necessary to support full UTC time scale (date & time).

Please connect 5071A PPS-output using quality RG58 cable. Use GPS antenna to provide initial ToD information (date & time).

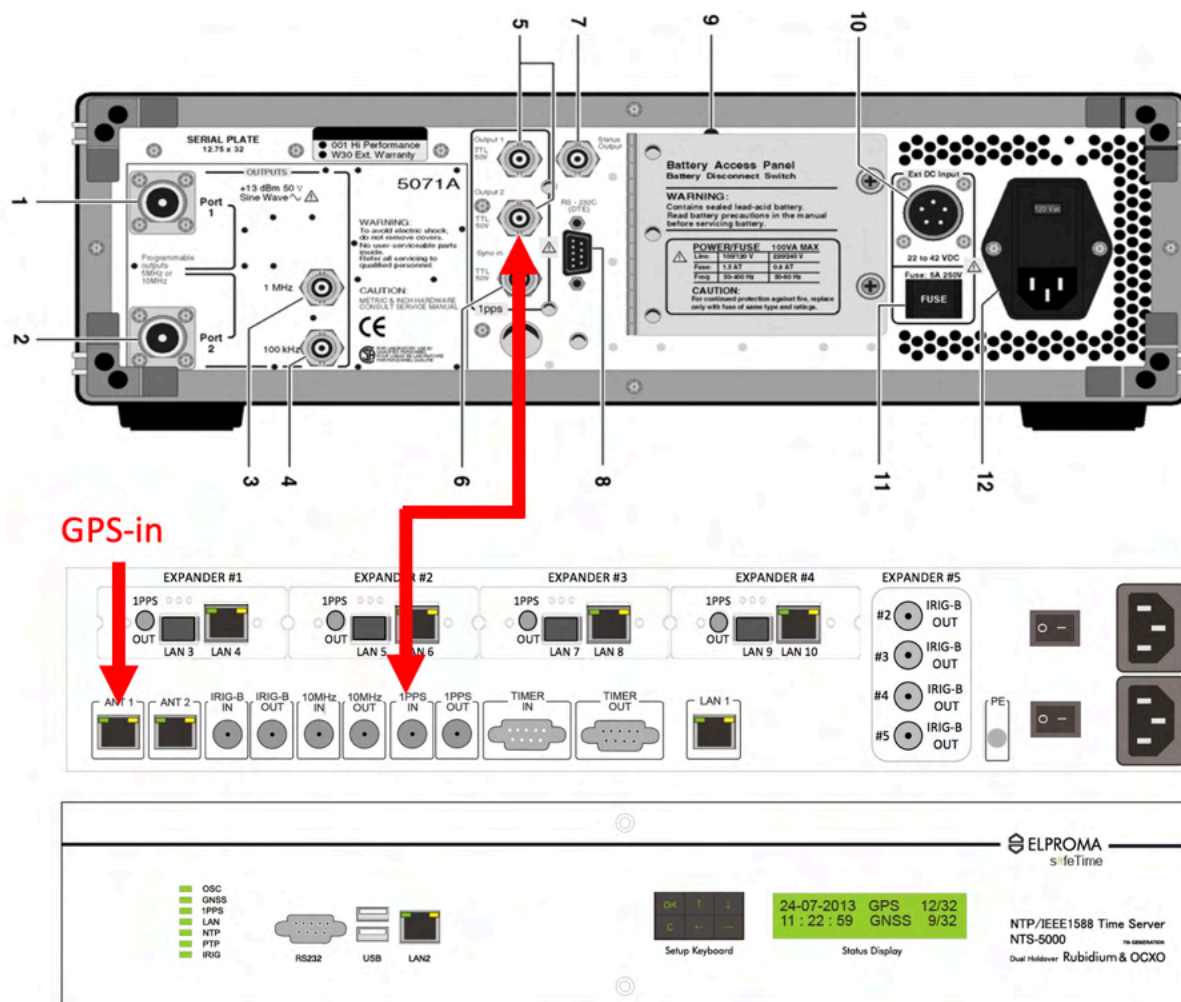

PPS reference is provided directly from 5071A. The initial ToD information is supported from GNSS.

In above connection scheme, the initial ToD (Time of a Day) is taken from GPS receiver connected to ANT1 (or ANT2). It can take several minutes (depends on quality of received GPS signals) before NTS server gets ready to synchronize to 5071A PPS. Once the NTS server is lock to GPS, it will start to synchronize to 5071A using PPS frequency reference, and it does not need GPS reference anymore.

Alternatively, the initial ToD information can be taken from another (remote) NTP server using network interface LAN1 (or LAN2). In this case your server will temporary reduce STRATUM to N-1 (where N means a STRATA of remote NTP server providing initial ToD information to your server). Once the ToD initialization (NTP) is done, your server will switch to PPS. Reference from 5071A increasing STRATA to STRATUM 1 operation. Once this information is done, you will not need remote NTP server anymore.

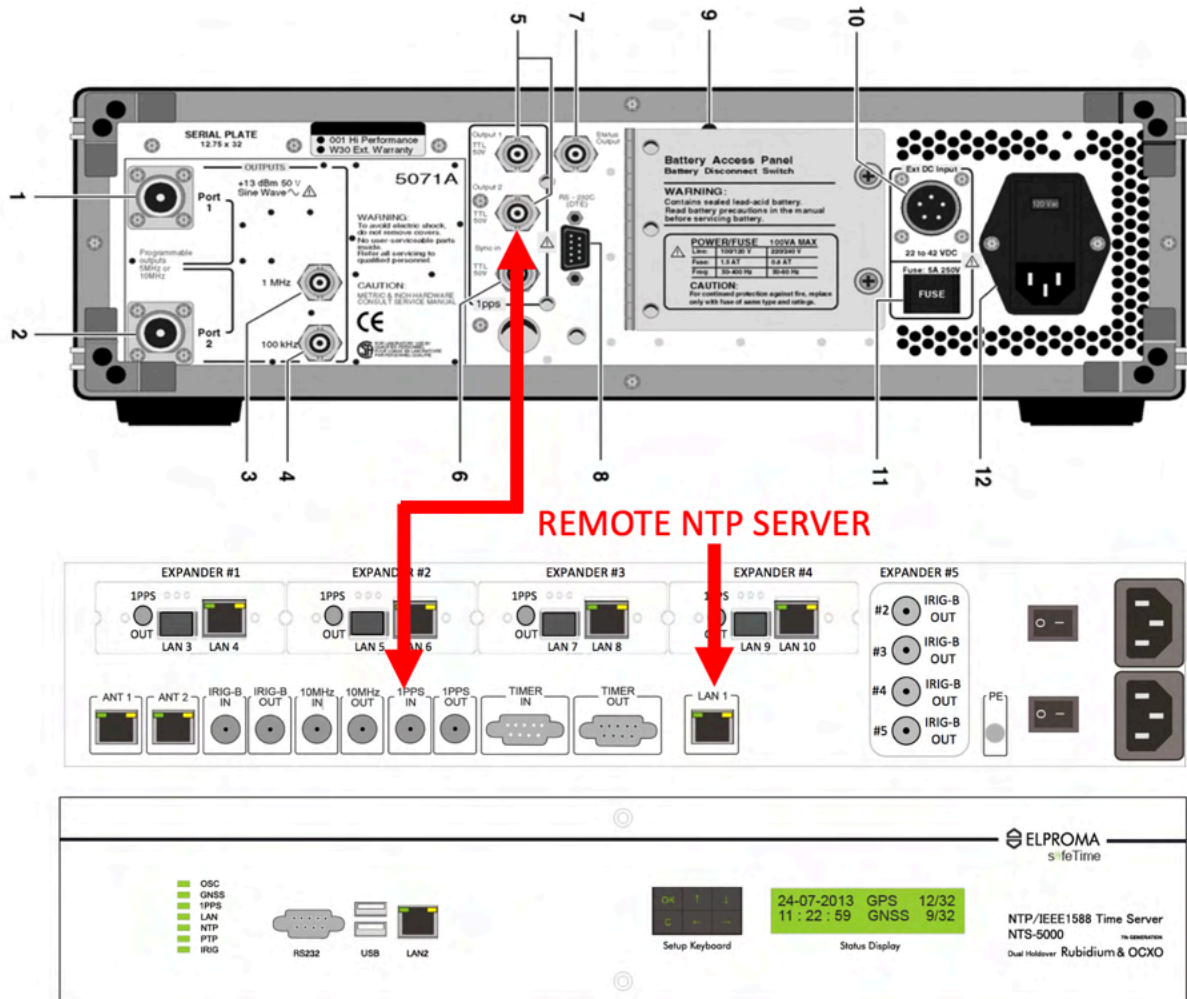

Singe frequency reference 1PPS synchronization of NTS. The initial ToD is taken from another (remote) NTP time server

**Scheme #2 - Installing special version of NTS with Cesium 5071A using both: PPS + ToD**

Elproma has developed solution that supports simultaneously 5071A using both: ToD timestamps and PPS frequency reference. Such dual PPS + ToD synchronization to 5071A does not need any GPS receiver nor remoted NTP server. Furthermore, you will not lose cesium telemetry facility due to fact NTS-x000 behaves 100% transparent for all Cesium data and PC requests.



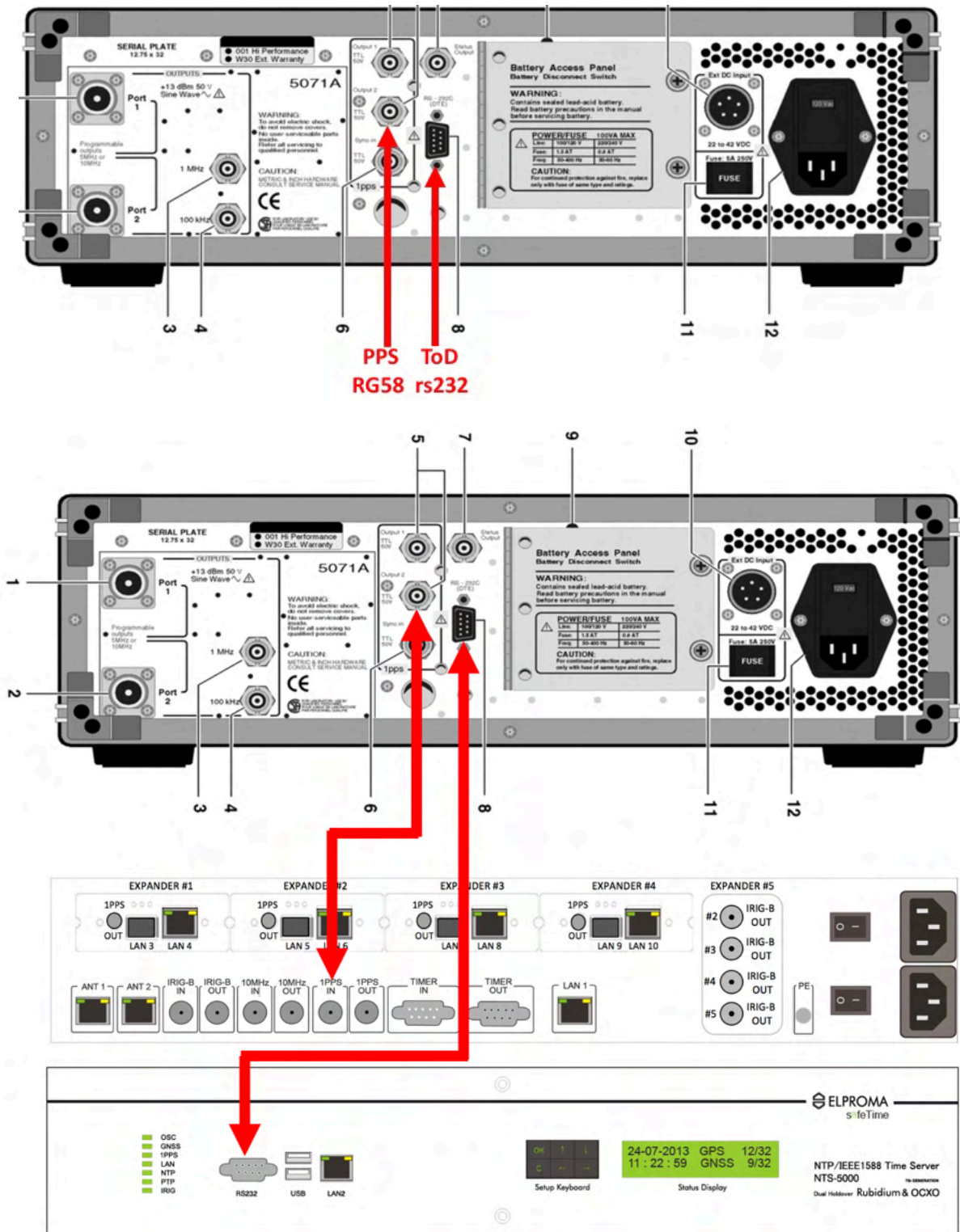

Connecting NTS-x000 to 5071A using PPS + ToD. Please use RG58 (PPS) and serial RS232 cable (D-SUB9 ended) cables.

**Preparing 5071A.** Find 1PPS-out and RS-232 (D-SUB) interface on the back panel of 5071A. Please connect BNC RG58 cable to PPS-out of 5071A. Then please install RS-232 cable.

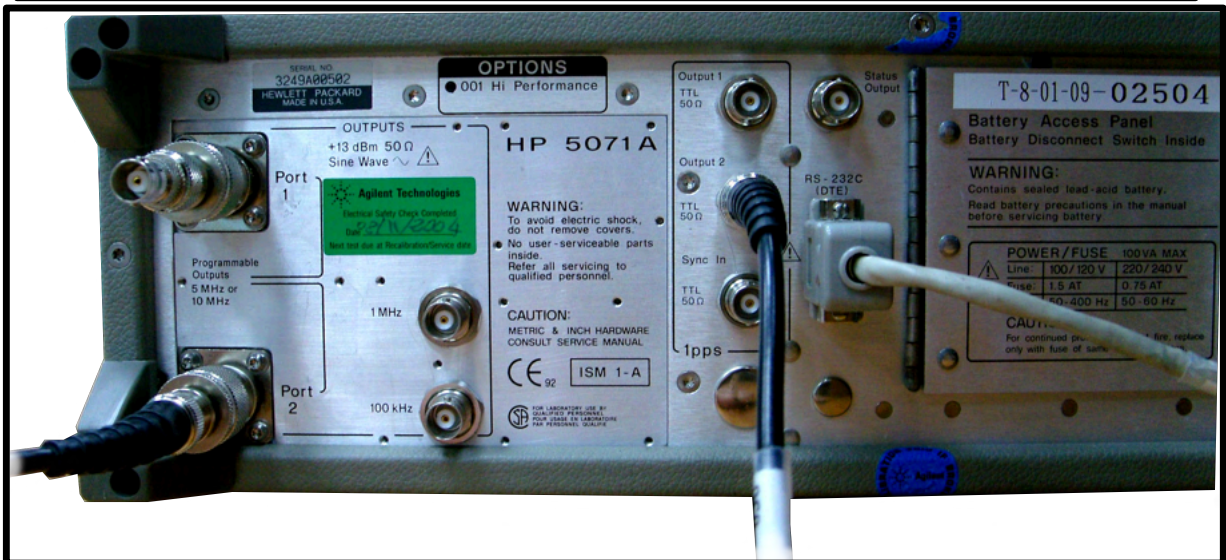
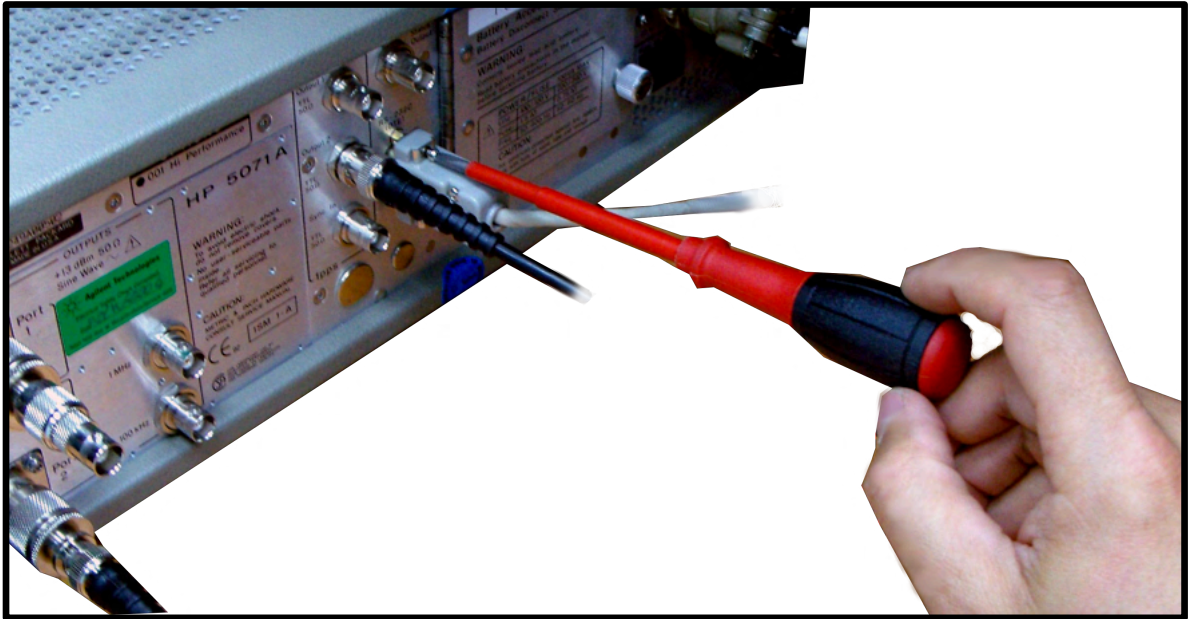

Properly connected cables to 5071A: PPS (BNC) and RS-232 (D-SUB9) – the 5071A back panel view

**Connecting 5071A and NTS-x000.** Please connect RG-58 (PPS) cable to back panel BNC of NTSx000 labeled PPS-in, and connect RS232 cable to **NTS-x000 front panel D-SUB9** connector as presented.

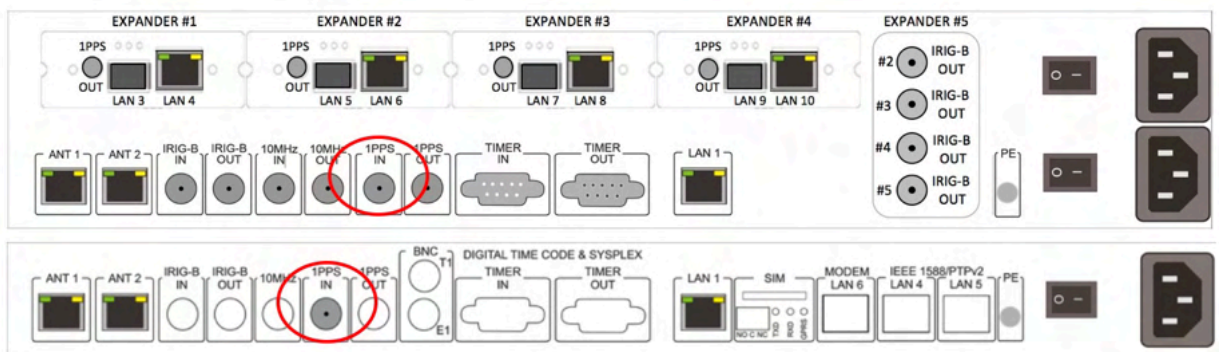



Connecting PPS (BNC) and ToD RS232 cables to NTS (the NTS-x000 back panel view)

**Connecting PC to NTS-x000.** Please connect RS232 cable to back panel TIMER-IN of your NTS-x000.

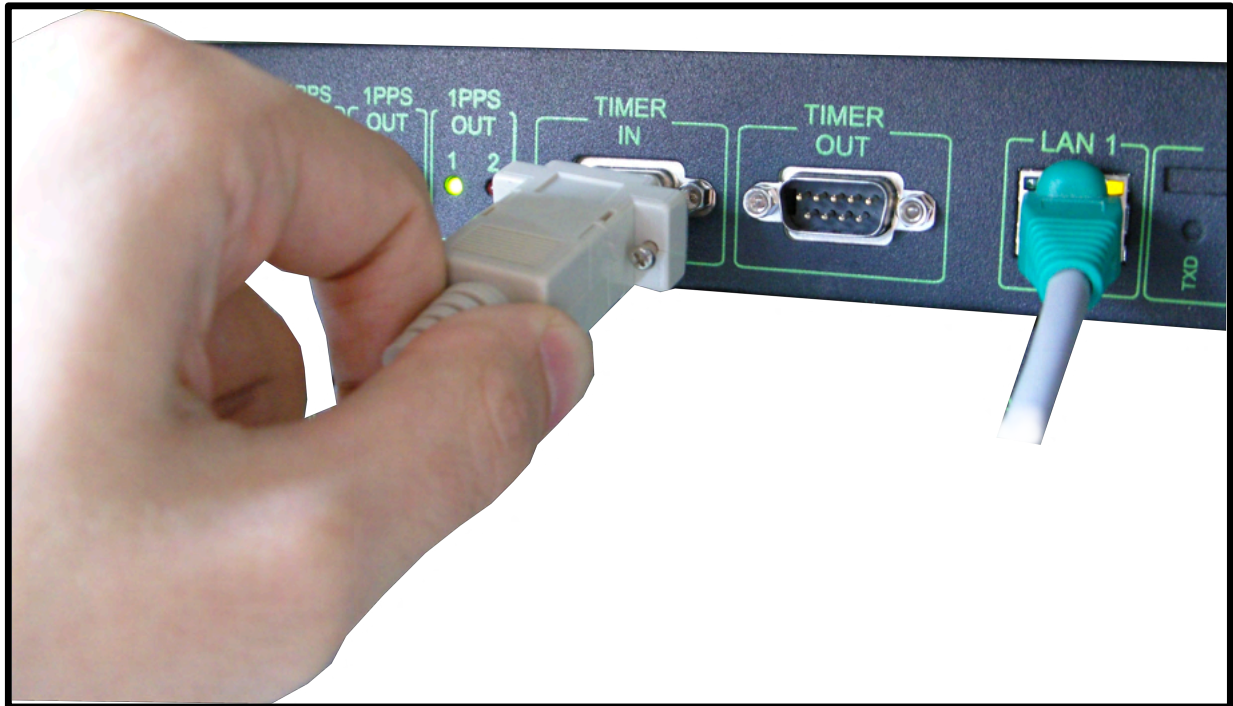

*Connecting PC to NTS-x000 using rs232 interface*

**HIGHLIGHTS:**

The PC is connected to **back panel D-SUB9** connector of NTS-x000.

The 5071A is connected to **front panel D-SUB9** connector of NTS-x000.

Your NTS-x000 behaves 100% transparent for all Cesium data and PC telemetry requests.

You will be able to trace Cesium telemetry data on your PC automatically.

## Software SETUP.

You are now ready to make one step software setup configuration.

Please execute your favorite web browser to access NTS-x000 software setup using HTTPS

Select "System" from main MENU, then please choose a last row labeled **"HP5071A Ref clock"**.

NTS-5000 Configuration Panel	
<b>Firmware version</b>	NTS-5000 2019/03/05
<b>LCD information</b>	[22-03-2019 OK ] [12:32:18 SAT A= 8/ 8] <input type="button" value="Refresh"/>
<b>Boot time</b>	Tue Mar 19 15:57:01 2019
<b>Uptime</b>	12:32PM up 2 days, 20:35, 2 users, load averages: 0.12, 0.12, 0.07
<b>Restart service</b>	<input type="checkbox"/> NTP daemon <input type="checkbox"/> Input Ant 1 <input type="checkbox"/> Input Ant 2 <input type="checkbox"/> OCXO <input type="checkbox"/> Rubidium <input type="checkbox"/> NTS server <input type="button" value="Restart"/>
<b>OCXO</b>	Version 2017-10-16 10:20:49 Work time 8 days, 1:18:28 Life time 818 days, 12:38:31 Synchronization status Synced PCB temperature 42.2C
<b>IRIG IN</b>	Version 2016-11-09 19:02:44 Work time 36 days, 23:55:09 Life time 817 days, 13:13:03 Synchronization status Synced
<b>IRIG OUT</b>	Version 2016-10-31 17:39:12 Work time 36 days, 23:55:09 Life time 817 days, 13:42:32 Synchronization status Synced
<b>RUBIDIUM</b>	Version PRS10_3.24_SN_41483 Temperature baseplate 41.7C Temperature case 71.2C
<b>HP5071A Refclock</b>	Enable <input checked="" type="checkbox"/> Pure <input checked="" type="checkbox"/> <input type="text" value="300"/> Select the speed of Cesium RS-232 port

The 2019 setup view

Please select "HP5071A Ref clock" checkbox labeled "ENABLE" to be ON.

This will let NTS-x000 time server begin to receive timing-data from 5071A via rs232 interface.

By clicking ON checkbox labeled "PURE", you will ensure there is no other ref. source of UTC time to be considered by your NTS-x000. This means only 5071A will be your reference of time and frequency. Saying in other words, by selecting PURE=ON, you ensure exclusive use 5071A cesium clock input.

Set correct baudrate (the default baudrate is 300).

Please save setting and restart NTS-x000 server.

You are now ready to use NTS-x000 with 5071A Cesium Clock.

To continue your configuration please refer to software SETUP.

**Older software SETUP version (models 2004-2018).**

Select "Services" from menu - then please choose "NTP".  
Select checkbox PURE to ensure the 5071A is the only ref. source of time for NTS-x000.  
Set correct baudrate (the default baudrate is 300).  
Save setting and restart NTS-x000 server

The screenshot shows the 'NTS Configuration Panel' for ELPROMA. The left sidebar contains a menu with categories: Interfaces (LAN1, LAN2), Services (SYSLOG, SNMP, NTP), Date/time (Leap second, Manual set, Time Zone), Authentication (Password, NTP MD5 Keys, SSH Key, SSL Key, RADIUS), Miscellaneous (DNS, Antenna direction, Firmware upload, GPS status data, Save settings), and Logout. The main content area is titled 'NTS Configuration Panel' and includes the website 'www.ntp-servers.com'. It features three sections: 1. 'Cesium 5071A' with a checked 'Pure 5071A' checkbox (description: 'Setting this option disables all other refclocks and backup servers, Cesium is then the only time source'), a 'Baudrate' dropdown set to '300', and a note 'Select the speed of Cesium RS-232 port'. 2. 'NTP Peer 1 (Backup server 1)' with an unchecked 'Enabled' checkbox (description: 'Set this option to enable peer 1 server querying'), an empty address field with an 'Error' message 'Enter address here (server must be a STRATUM 1)', an unchecked 'NTP MD5 Key enabled' checkbox (description: 'Set this option to enable encrypted communication with specified peer'), and an empty MD5 key field. 3. 'NTP Peer 2 (Backup server 2)' with an unchecked 'Enabled' checkbox (description: 'Set this option to enable peer 2 server querying'), an empty address field with an 'Error' message 'Enter address here (server must be a STRATUM 1)'. The interface has a dark blue header and a light grey sidebar.

Old 2004-2019 setup view

## 26. Extra Hardware – GNSS NTS-antenna

Time server is equipped with 1pcs. of **NTS-antenna**, however it can support max. 2pcs. Antenna is delivered with complete mounting set including *mast*, *mounting grip*, *screws*.

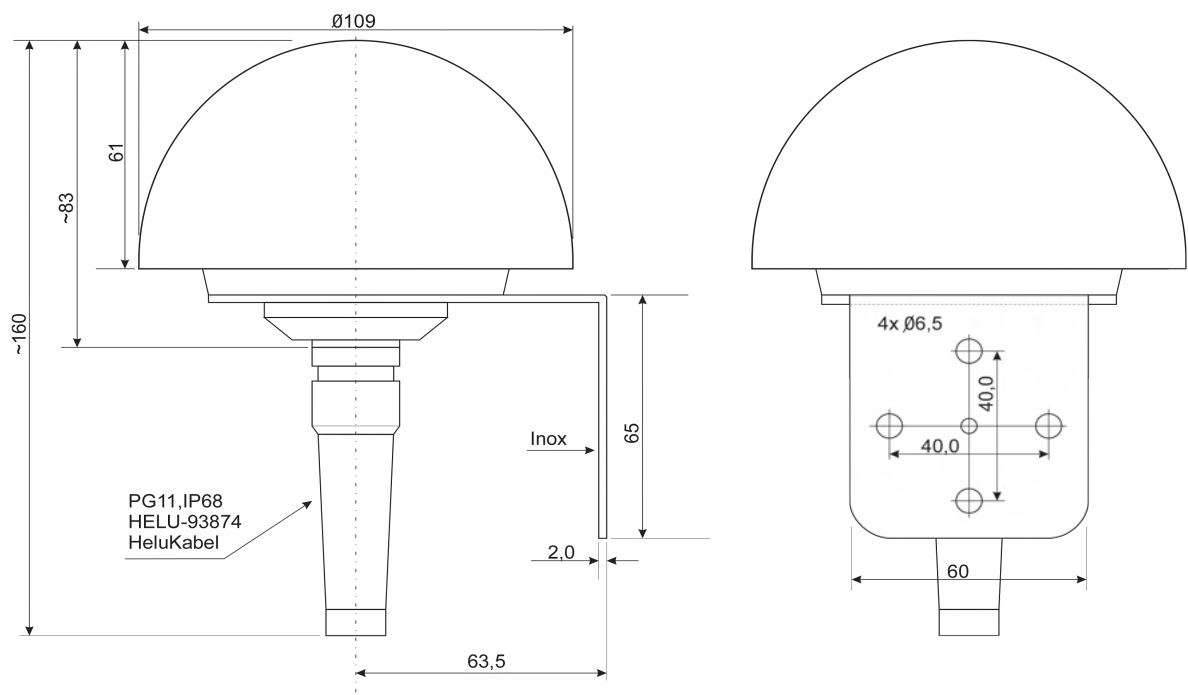
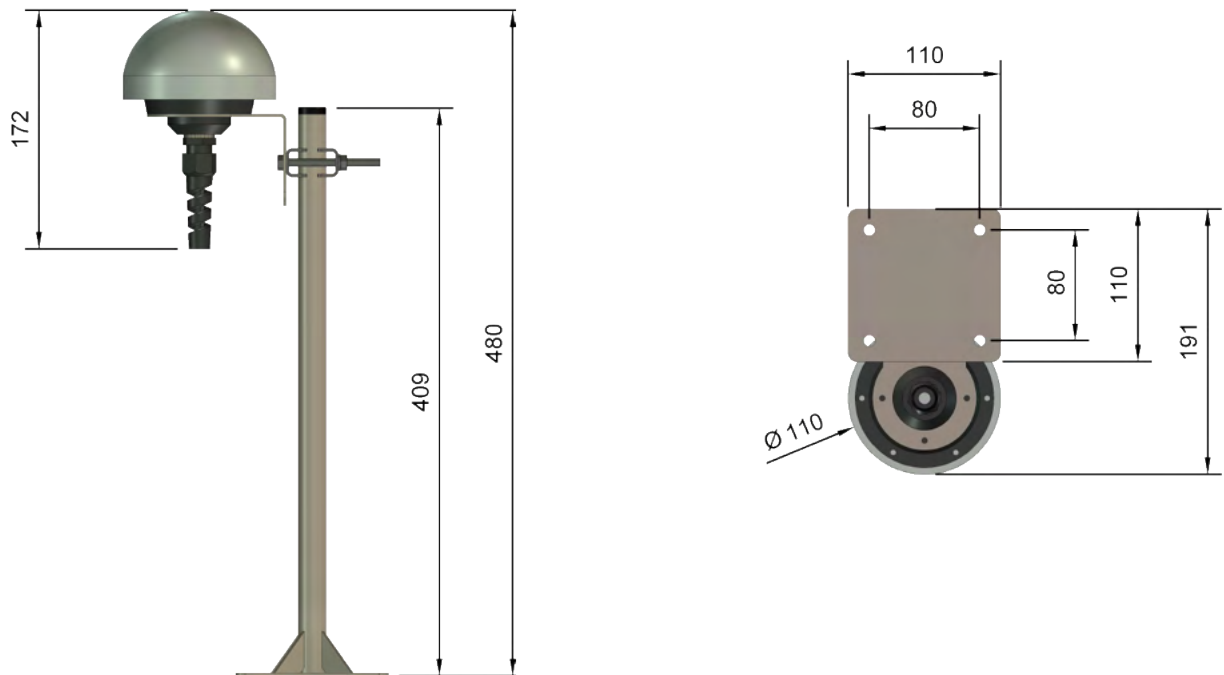

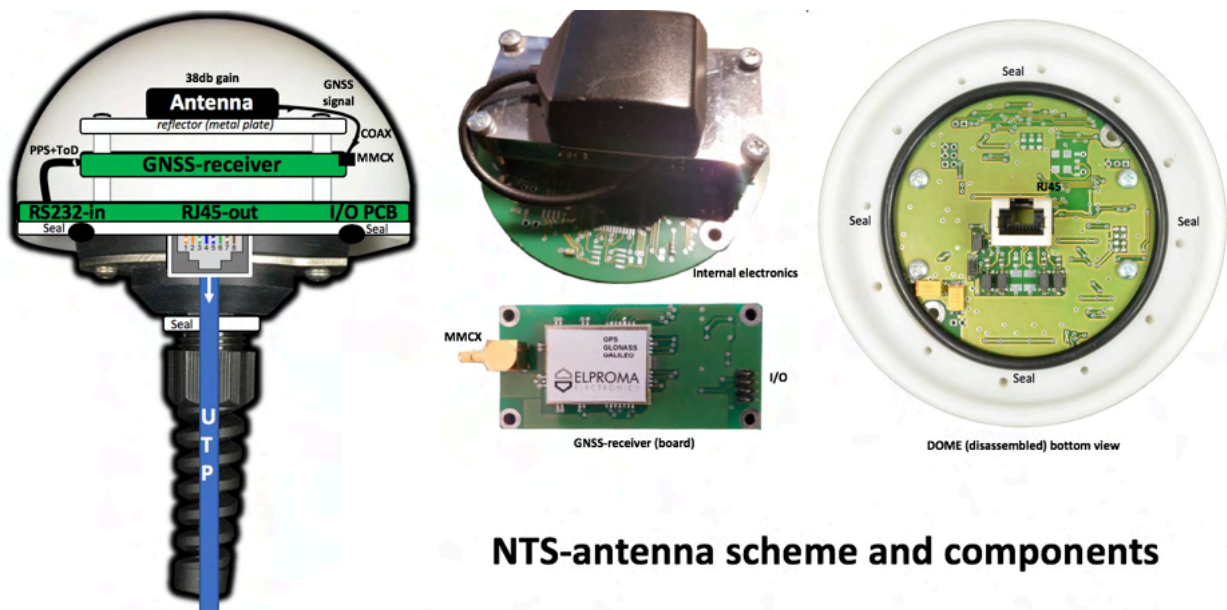

## NTS-antenna scheme and components

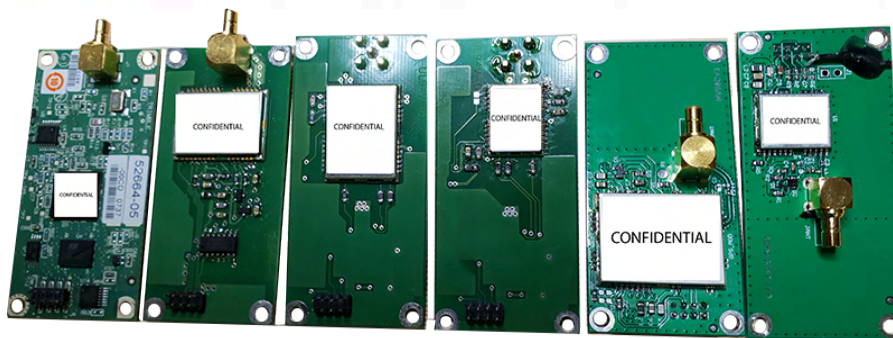

Standard NTS-antenna is made by vandal resistant DOME housing. Inside there are:

- **GNSS coil antenna w/ 38dB signal gain** (located on special RF reflector plane),
- Replaceable **GNSS receiver board** supporting GPS, GLONASS, BEIDOU\*, GALILEO\*,
- Round **I/O frequency converter** to electric signal rs485 w/ 1PPS support (RJ45 ended)

Elproma offers various of exchangeable GNSS-receiver boards each powered by different GNSS receivers. The NTS-antenna is connected to NTS using UTP (unshielded) or STP (shielded) cat.5 cable. The UTP/STP cable is not included and needs to be purchased separately. Elproma always recommend to use external environment version of cable. The maximum distance for single antenna is 0.7km from NTS time server. Using 2pcs. independent NTS-antennas ensure GNSS hardware redundancy, but also it is improving cyber security of solution. Using 2pcs. of antenna enables “geographical” diversification of shortrange jamming/spoofing risk of attack..

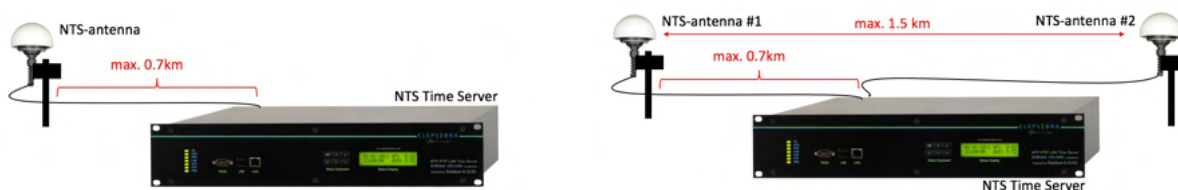

Single NTS-antenna distance is limited to 0.7km. Two antennas reduces effectivity of jamming/spoofing



Using 2x independent NTS-antennas you are ensuring GNSS hardware redundancy, but also you are improving cyber security. The 2x antennas can be connected on max. distance of 1.5km from each other, enabling “geographical” risk diversification of using portable shortrange jamming/spoofing devices.

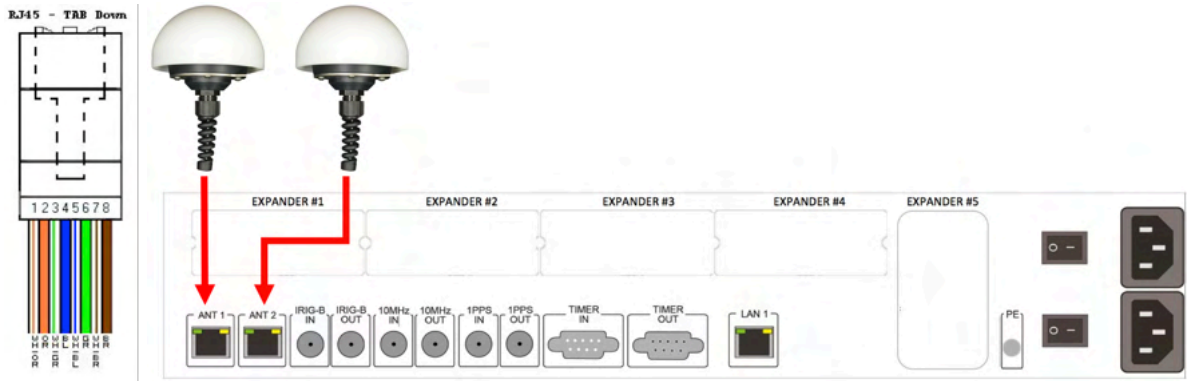

ANT-1/ANT-2 RJ45 (pin)	Signals	Std. UTP cable color
1	PPS+	White/Orange
2	PPS-	Orange
3	ToD+ (TR+)	White/Green
4	JAM/SPF- (or DCF-)	Blue
5	JAM/SPF+ (or DCF+)	White/Blue
6	ToD- (TR-)	Green
7	+VCC (+24VDC)	White/Brown
8	0V	Brown
GND	GND	Not used

ANT-1/ANT-2 interfaces can be configured individually from setup level

- **INPUT** supplying ref. time to NTS-antenna in one of modes:
  - **BINARY mode (default)**, supporting leap second (secured mode)
  - **NMEA183 text mode**, not supporting leap second (unsecured)
- **OUTPUT** emulating NMEA183 to another server
- **OFF** - port is disabled

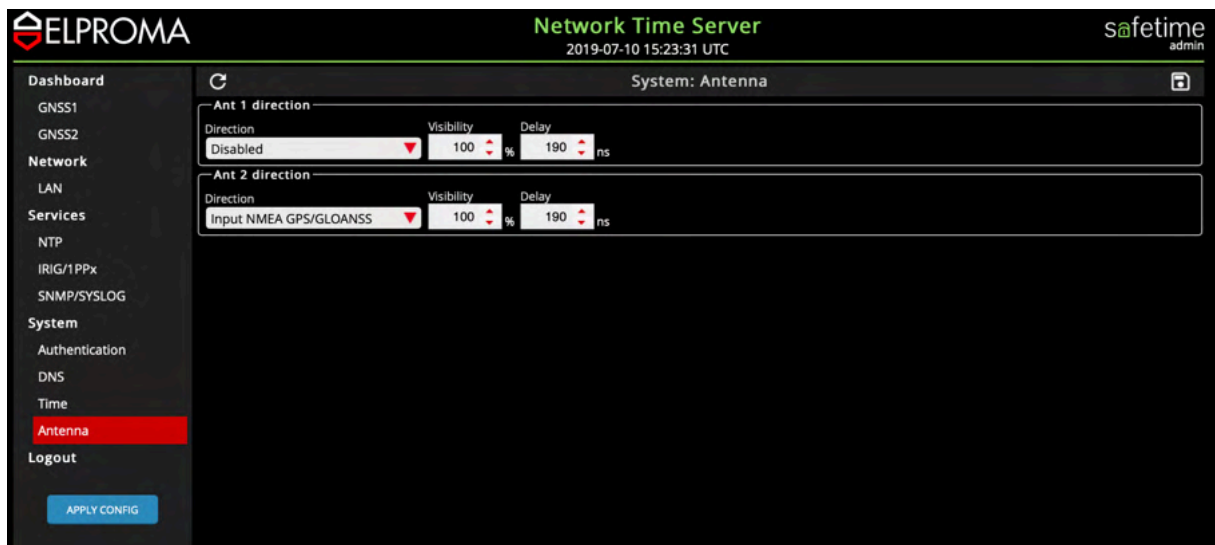

## LED indicators

There are 2x LED (red & green) on the back panel of NTS time server (ANT1, ANT2) RJ45 interfaces:

GREEN LED	STATUS
OFF	NTP daemon not started
ON	NTP daemon started
BLINKS (NTS-3000 and -4000)	Synchronized to OCXO ( <i>if option applicable</i> )
BLINKS (NTS-5000)	Synchronized to 1PPS from external BNC connector, Rubidium or OCXO ( <i>if option applicable</i> )

RED LED	STATUS
OFF	No GNSS signal
ON	Synchronized to GPS (NMEA)
BLINKS	Synchronized to GPS (1PPS)

## Mounting NTS-antenna

When mounting the antenna, ensure the antenna has a clear view of the full horizon and is at least 2 meters away from telecom, energy transmission sources which may interfere with reception. Avoid the direct path of any microwave links.

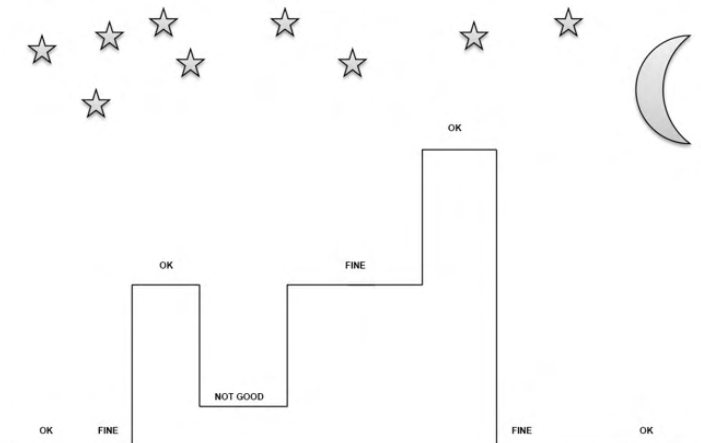

“OK” – recommended places, “FINE” – acceptable for multipath-mitigation version, “NOT GOOD” – do not install there

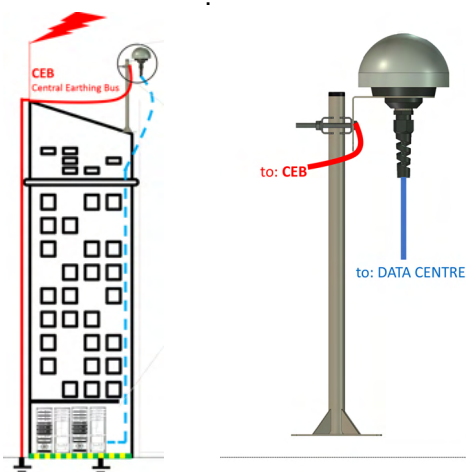

When mounting NTS-antenna, please ensure all the mast and bracket are properly grounded to **ECB – The Grounded Central Earthing Bus**.

This must be achieved by employing a certified, low impedance connection (a broad, flat lightning conductor strap of sufficient thickness to provide adequate mechanical durability) able to carry the thousands of amperes which may flow. Attaching the antenna mast and mounting clamp onto a pole which is correctly grounded is the recommended method. Optionally another 2<sup>nd</sup> lightning arrester, a of NTS-protect-2 system should be mounted where the antenna cable enters the building and properly grounded to earth termination.

## 27. Extra Hardware – Lighting NTS-protect

### Introduction

As the NTS-antenna is a roof mounted device to ensure clear view of the sky. Therefore, it is likely to be exposed to lightning strikes. The protection against this is afforded by ensuring adequate grounding of all mountings as described below. The NTS-protect basis upon the rule of voltage compensation in accordance with IEC 61024-1 standard. It stipulates upholding safe levels of overvoltage that will not damage the insulation in all protected electrical I/O circuits of the NTS-x000 servers.

The NTS-protect system has been designed so to be in compliance with the regulation *Journal of Laws, No. 75 of June 15, 2002 items 180 and 183* providing that wiring systems should secure against switching overvoltage and lightning surge, and that voltage limiters shall apply thereto.

### The Lighting Arrester

Elproma uses Weidmuller lightning arrester type 1348590000 as a basic component of NTS-protect. This product has been well laboratory tested and it is approved for using with all NTS Time Servers. It is ultrafast (1ns switching time), low latency (630 picosecond delay) surge and overvoltage breaker. It is metal housing and therefore, a vandal resistant too. Device is IP20 and can operate -50C to +85C.

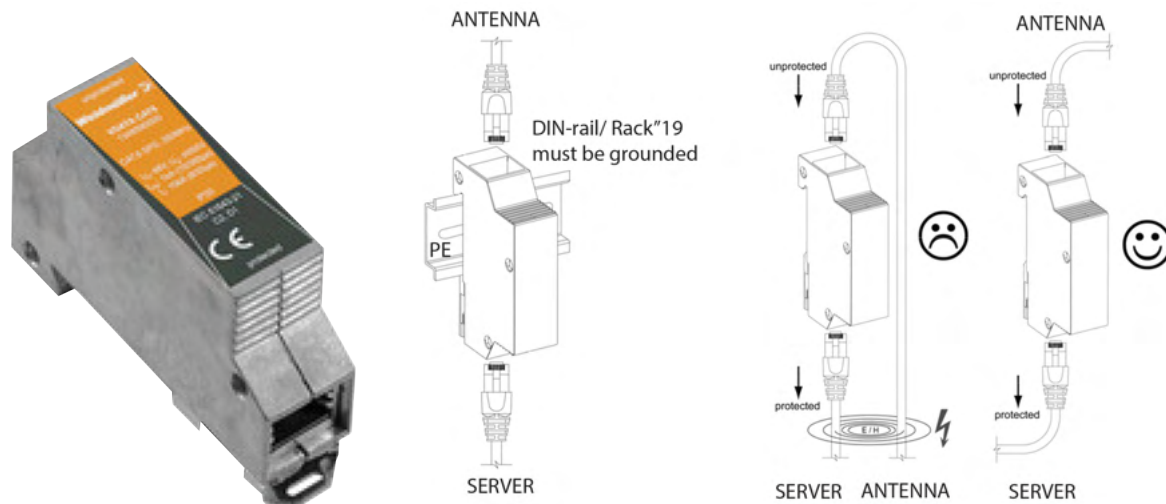

The view of lightning arrester from Weidmuller, it is very important to ground (PE) arrester and plane a way of antenna cabling.

**IMPORTANT NOTE!** The lightning arresters are never 100% efficient, a residual attenuated electrical pulse being transmitted down the antenna cable, may still contain sufficient energy to damage equipment within the building. Therefore, it is very important to PE ground it and plane a way of cabling.

For above reasons, the 2<sup>nd</sup> (NTS-protect-2 configuration) or even the 3<sup>rd</sup> (NTS-protect-3 configuration) lightning arresters might be considered at the begin and at the end of the antenna cable. There are 3 versions of NTS-protect system:

- 1) **NTS-protect-1** (*std*) called NTS-protect , a single arrester system mounted at rack 19 cabinet
- 2) **NTS-protect-2** (*extended*) NTS-protect-1, plus extra arrester at the entrance of a building
- 3) **NTS-protect-3** (*max*) NTS-protect-2, plus extra 3<sup>rd</sup> arrester mounted to antenna mast

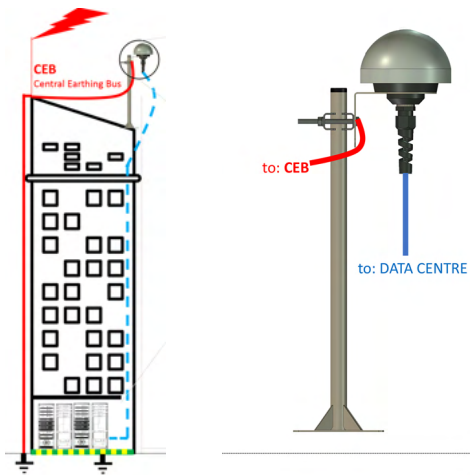

When mounting NTS-antenna, please ensure all the mast and bracket are properly grounded to ECB - Grounded Central Earthing Bus. This must be achieved by employing a certified, low impedance connection (a broad, flat lightning conductor strap of sufficient thickness to provide adequate mechanical durability) able to carry the thousands of amperes which may flow. Attaching the antenna mast and mounting clamp onto a pole which is correctly grounded is the recommended method. Optionally another 2<sup>nd</sup> lightning arrester, a of NTS-protect-2 system should be mounted where the antenna cable enters the building and properly grounded to earth termination.

The NTS time-server communicates with the GNSS NTS-antenna module via low-signal circuits of the voltage levels not exceeding up 24VDC. The transmission is carried out through std. UTP or STP cat5+ cable of a core diameter equaling 0,5 mm.

## Mounting NTS-protect-1

This is default std. single arrester protecting system. The installation is shown on below picture.

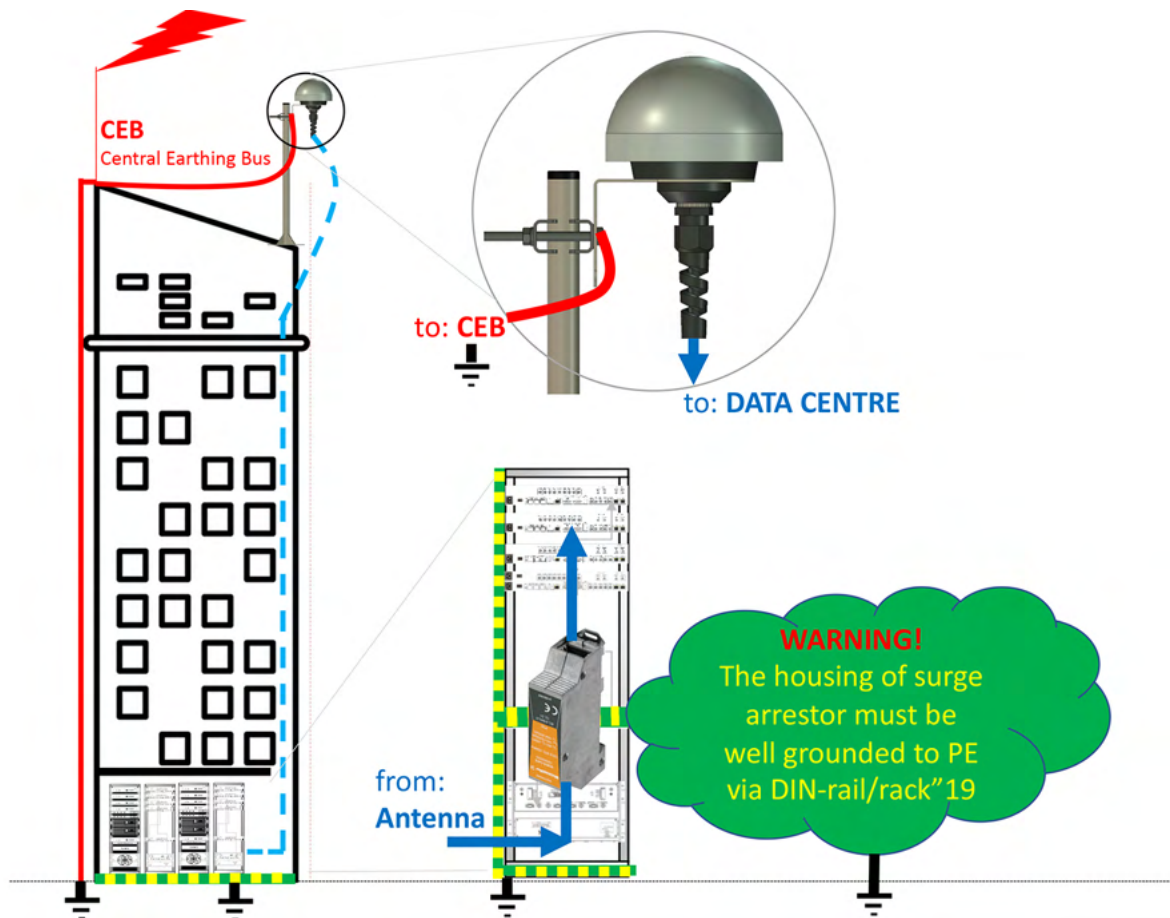

## Installation:

1. Ensure the NTS-server is power-OFF.
2. Ensure disconnecting antenna cable from ANT1 (or ANT2) RJ45 interface of NTS
3. Mount DIN-rail on the bottom back part of rack"19 cabinet. Ground it PE to rack"19 cabinet
4. Connect NTS-antenna RJ45 to unprotected (top) signed RJ45, and NTS-x000 to protected RJ45 (bottom) connector of the surge arrester. Use std. RJ45 configuration as described in antenna installation chapter. All arrester connections a both side pin-2-pin (1-1 etc.).



DIN-rail mounted on the backside of rack"19 cabinet must be grounded (PE)

## Mounting NTS-protect-2

This is additional 2<sup>nd</sup> arrester mounted on the antenna cable at the enter to the building. The NTS-protect-2 includes NTS-protect-1 therefore please refer to previous chapter for instllation instructions. The 2<sup>nd</sup> arrester should be mounted as near as possible to enter to the building and must be grounded to PE or to external CENTRAL EARTHING BUS.

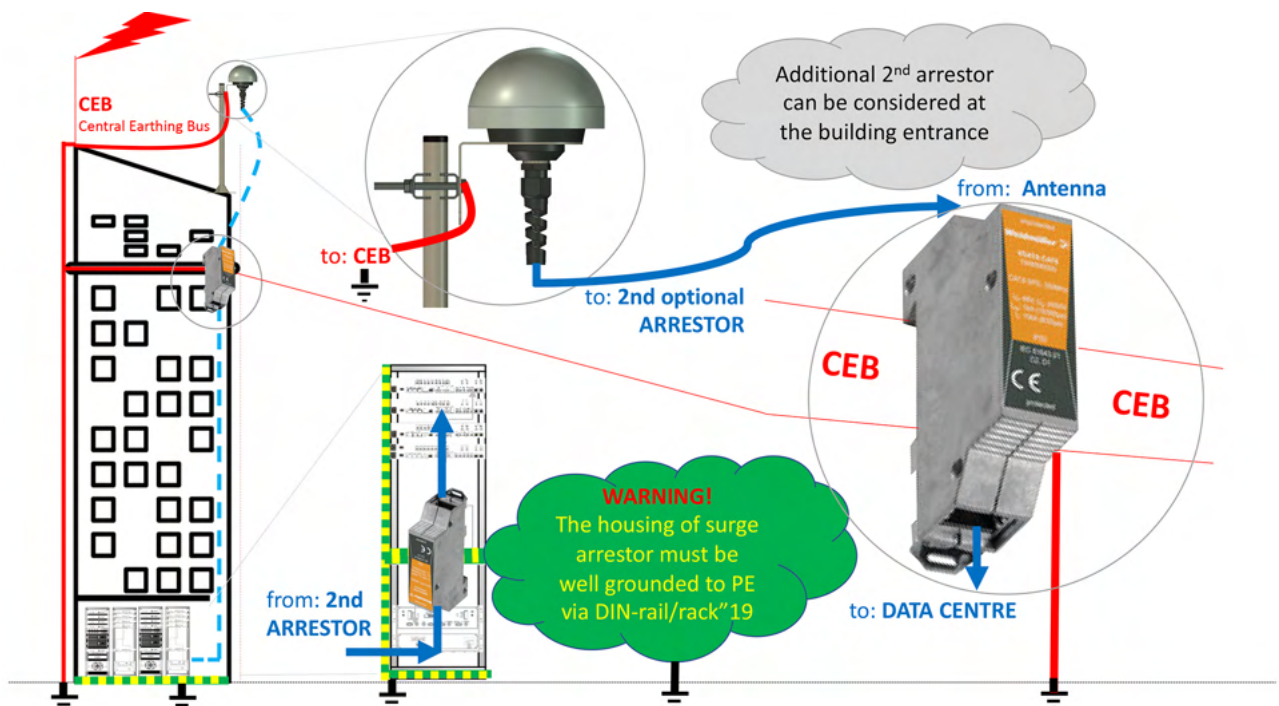

## Installation:

1. Ensure the NTS-server is power-OFF.
2. Ensure disconnecting antenna cable from NTS-antenna and from ANT1 (ANT2) RJ45
3. Mount 2<sup>nd</sup> arrester near place antenna cable goes into the building and ground it.
4. Ensure grounding (min. PE) of surge arrester. Best if grounded to CEB.
5. Connect NTS-antenna RJ45 and plug antenna into ANT1/ANT2 of NTS time server

## Mounting NTS-protect-3

This is the 3<sup>rd</sup> extraordinary arrester mounted to the mast of NTS-antenna. This option includes NTS-antenna2. (and intermediate automatically it includes NTS-antenna-1 too) so please ref. to previous pages of installation guide first. Actually, the NTS-protect-3 change from std. NTS-antenna to one with extra 3<sup>rd</sup> arrester mounted on the mast (see below). Currently Elproma does not support waterproof (IP-65/IP-68) housing for 3<sup>rd</sup> arrester (IP-20). Please purchase housing locally.

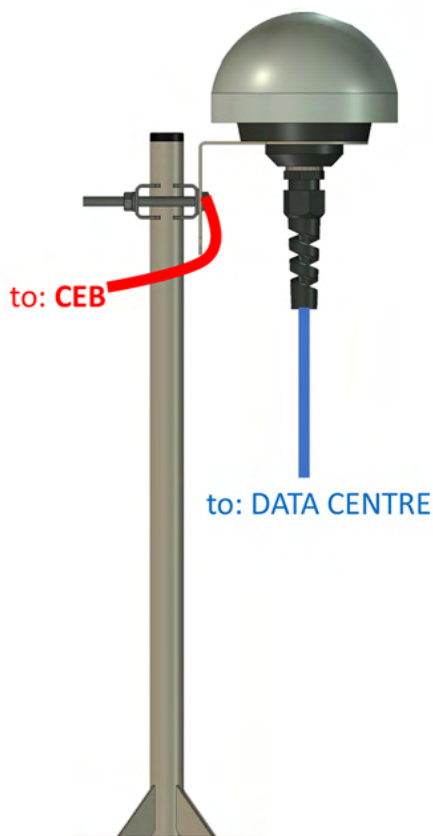

NTS-antenna (NTS-protect 1 & 2)

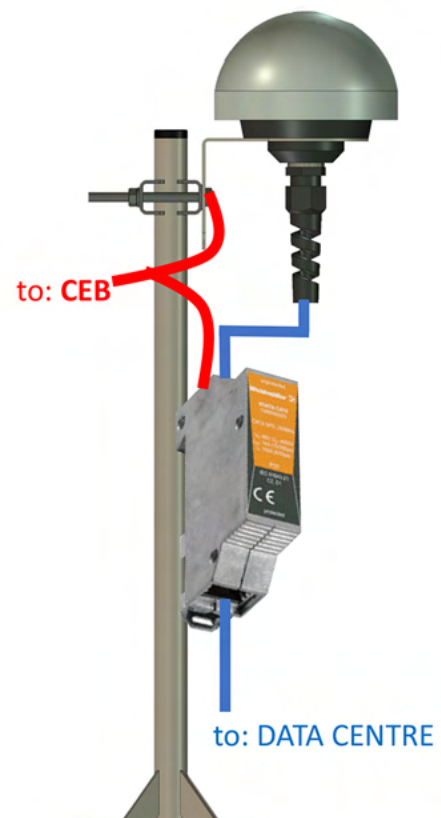

NTS-antenna at NTS-protect-3

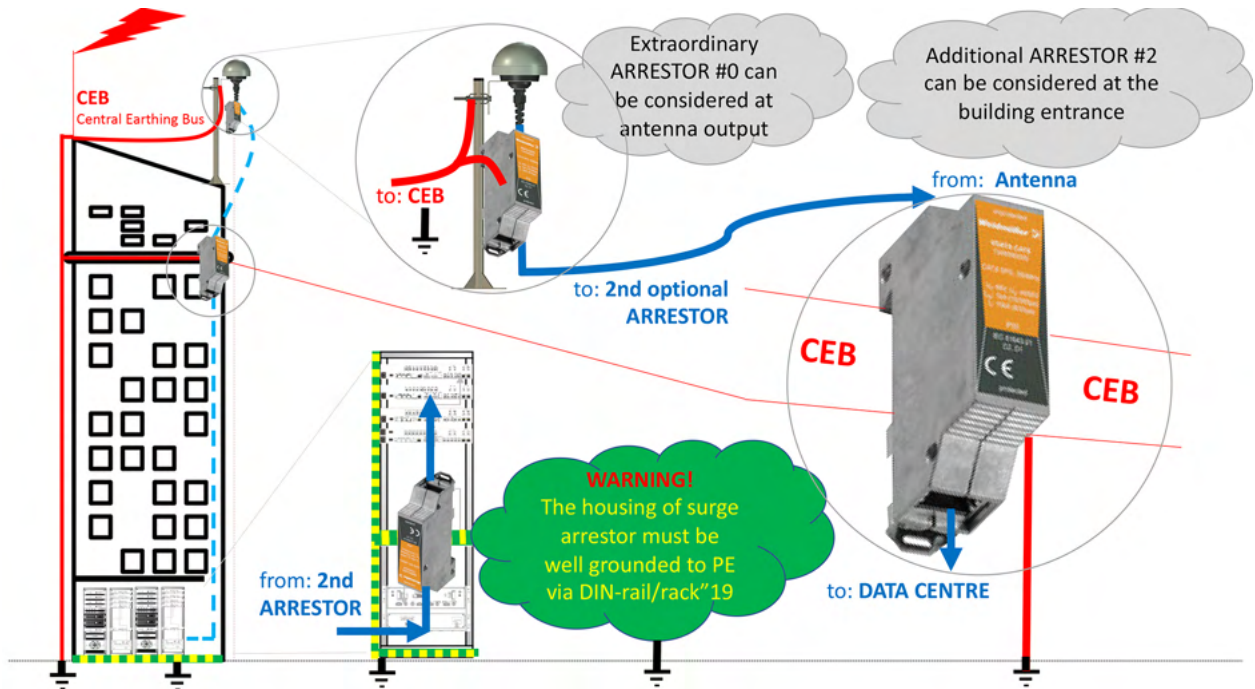

NTS-protect-3 installation diagram. The NTS-protect-2 (NTS-protect-1) should be installed first.

# 28. Extra Hardware – Fiber Optic Converter

## Introduction

The FO-01 enable fiber optic NTS-antenna connectivity to NTS-x000 (any server model). It is requiring 4pcs. of **multi-mode fibers** to supporting: ToD-in, PPS-in, ToD-out, PPS-out. Minimum configuration is requiring pair of FO-01 device: one for Master (sender) to support NTS-antenna, 2<sup>nd</sup> Slave (receiver) to support NTS-x000 server. More advanced configurations enable functionality of sharing single NTS-antenna between multiple NTS-x000 time servers.

The max. fiber connection distance is 1.5km (1 mile) end-to-end device. No intermediate devices such as: switches, routers, splitters, amplifiers are allowed between FO-01 devices. To ensure NATO standards of cyber-security the FO-01 scheme and BOM is available on request for security auditors.

The FO-01 device is symmetric, and it does not meter if it will support antenna or server. However, in case of NTS-antenna side FO-01 converter requires extra external power supply 24VDC. The FO-01 time server side is powered directly from NTS-x000 via RJ45 electric interface.

The FO-01 is ready to use device, fully automatic unit with auto configuration.

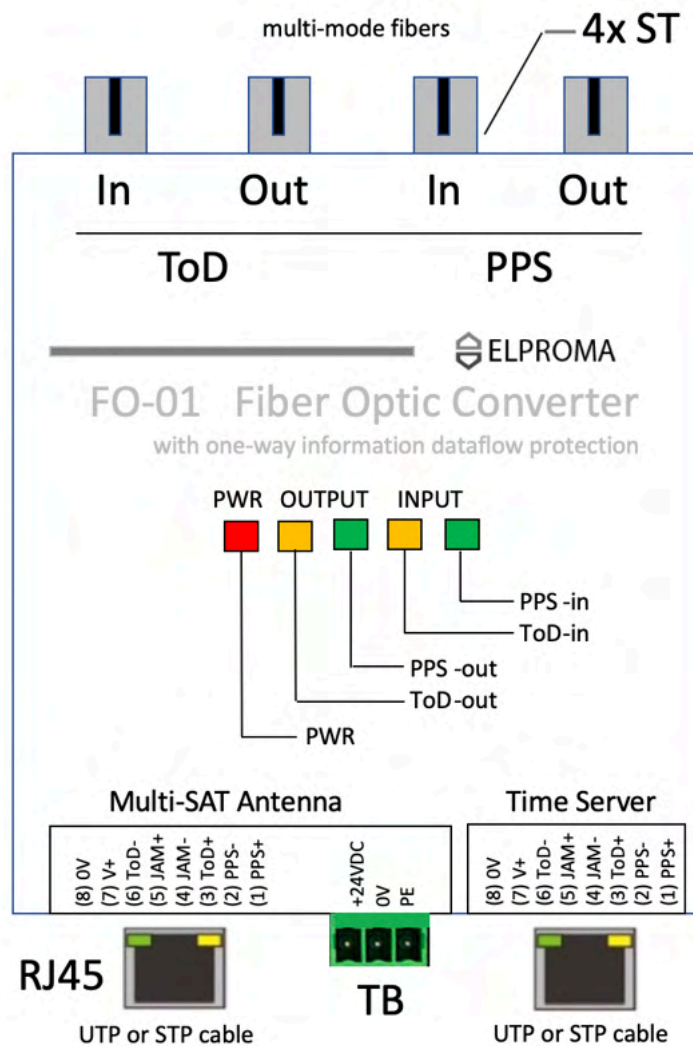

FO-01 Electric-2-Fiber Connector. Antenna side requires external power supply +24VDC connected via terminal block (TB)



## Intercom multi-mode fiber connection

To connect pair of FO-01 devices please use 4pcs. of multi-mode fibers max. 1.5km and connect them using crossed configuration as presented below:

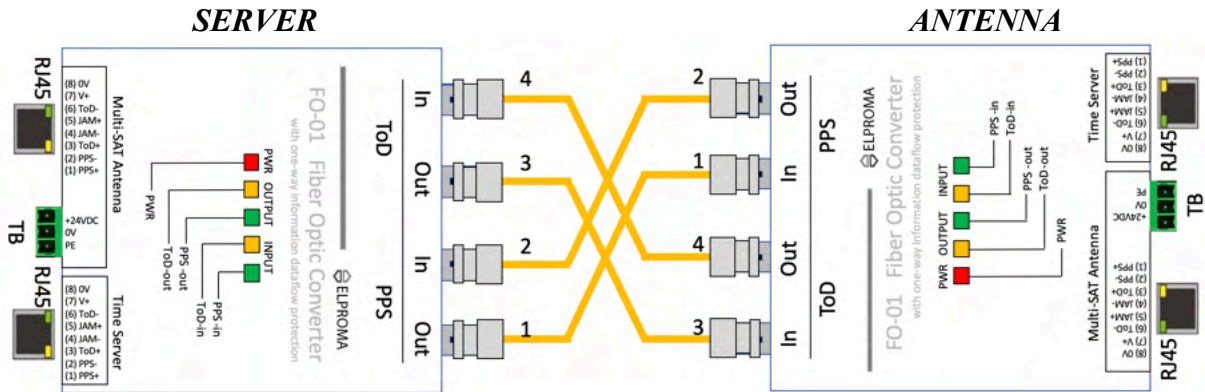

Intercom fiber connection of single pair of FO-01

## Connection Converter To Server

You can use both ANT1 and/or ANT2 server interface RJ45 for connecting FO-01 to NTS-x000 time server. In this configuration FO-01 is powered directly from NTS-x000 time server interface. The max. UTP/STP cable connection between FO-01 and NTS-x000 is limited to 0.7 km.

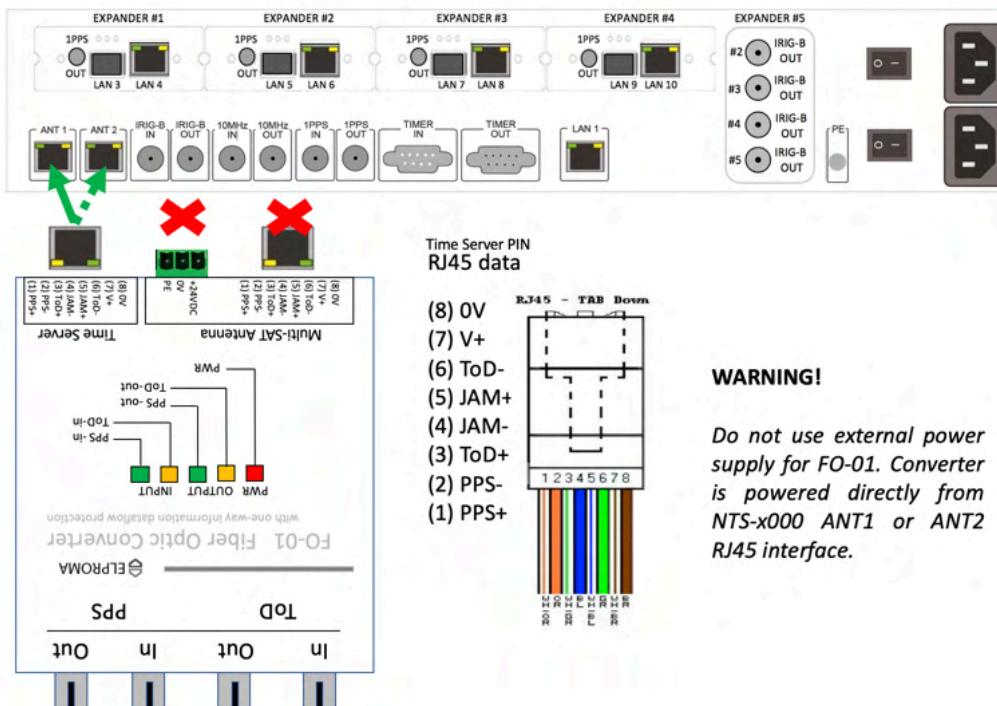

## Connection Converter To Antenna

When connecting NTS-antenna and FO-01 there is necessary to use external AC/DC power supply. The max. UTP/STP cable connection between FO-01 and NTS-antenna is limited to 0.7 km.

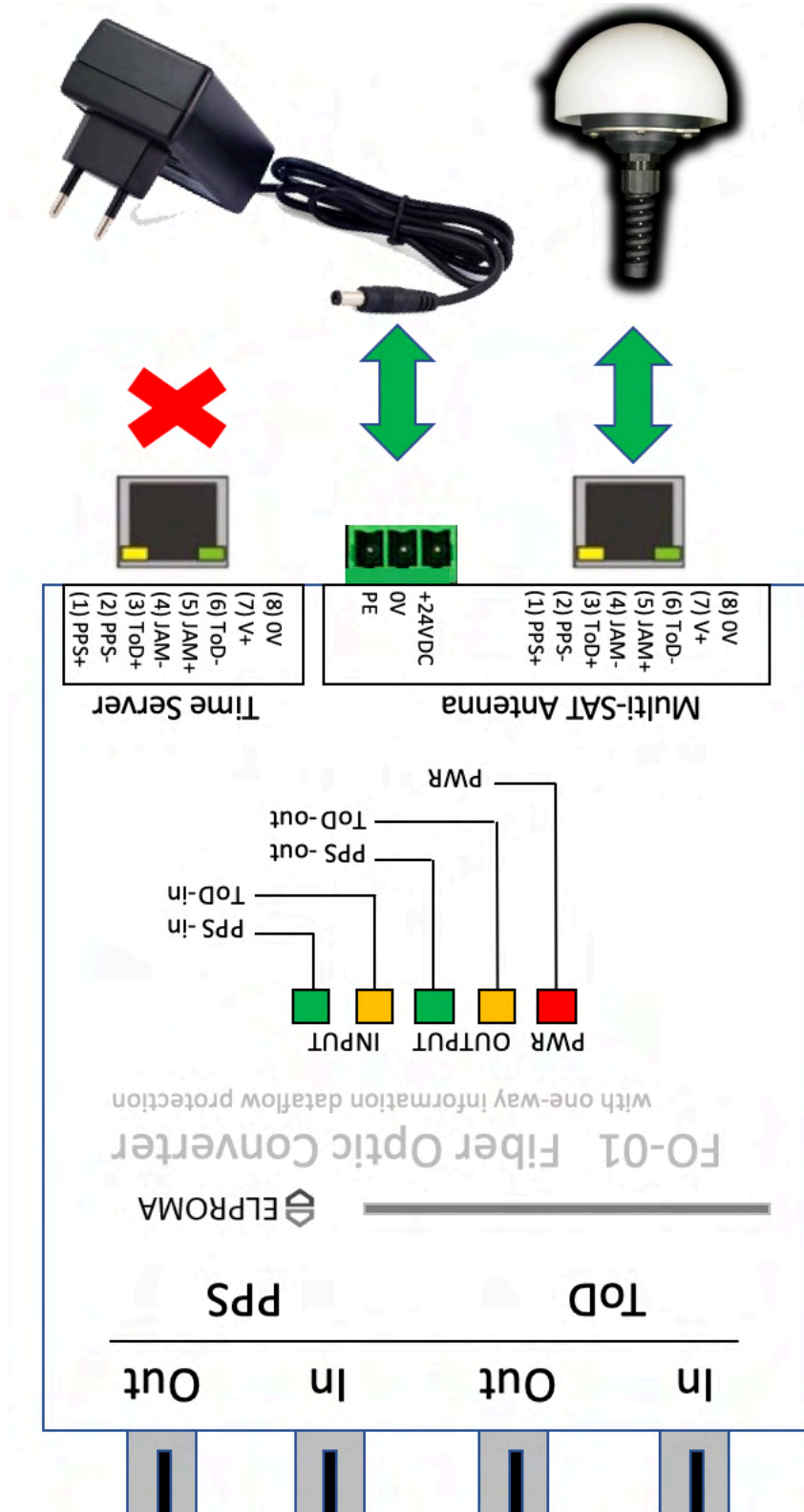

You can use UTP cat 5. On max. distance of 0.7km from FO-01 supplying NTS-antenna. This side requires external power supply 24VDC

## **SOFTWARE SETUP WWW**

# **Setup WWW**

## 29. Software WWW – Login

**IMPORTANT NOTE!** New 2019 setup is not compatible to Internet Explorer (IE) browser. All other browsers are supported. Elproma recommends **Chrome** and **Firefox** web browsers.

New 2019 web SETUP is available via LAN1 or LAN2 interface only. Other interfaces as LAN3-LAN10\* does not support software SETUP directly, and they can be configured via LAN1-LAN2 only. Please connect your PC to LAN first, and ensure it operates in same IPv4 subnet. The factory defaults are specified earlier in chapter “QUICK INFO – Restoring Factory Defaults”. Only single exclusive access is available per single server. If you access it via LAN1 the setup will not be available via LAN2 or RS232 etc. Please type LAN1 (LAN2) IPv4 address in your favourite web browser. Press the lock icon located in right upper corner of screen to activate LOGIN screen. The user default login and password are:

**Username: admin**  
**Password: 12345**

and click LOGIN button located below.

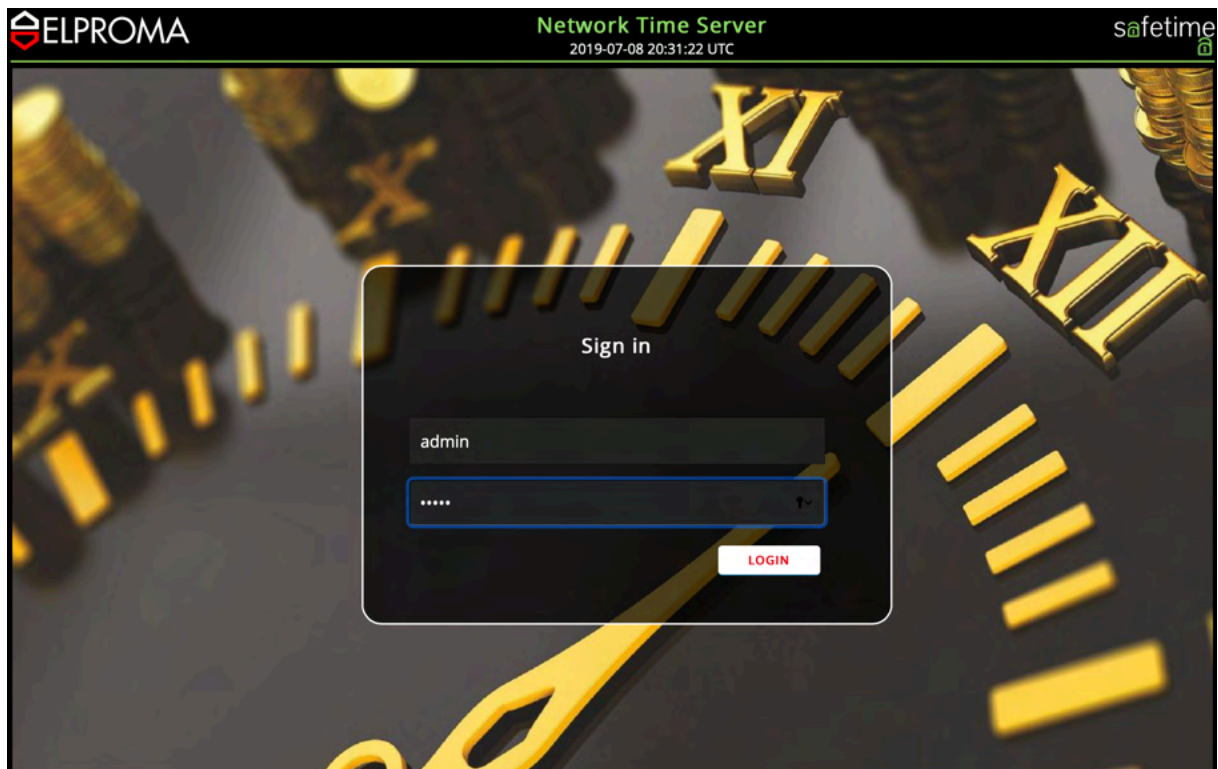

# 30. Software WWW – Main Screen (SCADA)

Directly, after successful LOGIN the main DASHBOARD screen appears.

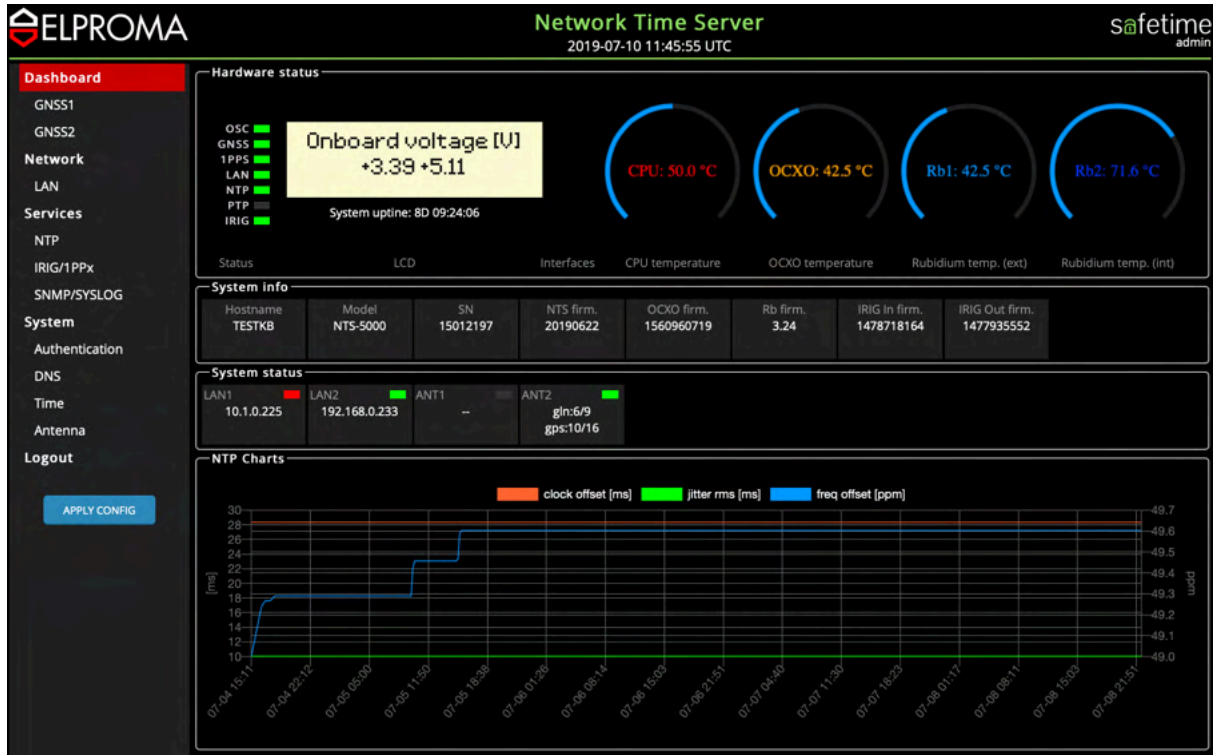

The DASHBOARD of a new SOFTWARE WWW setup keeps basic SCADA monitoring functionalities. The following parameters corresponds real-time to data available on physical front panel of NTS-x000.

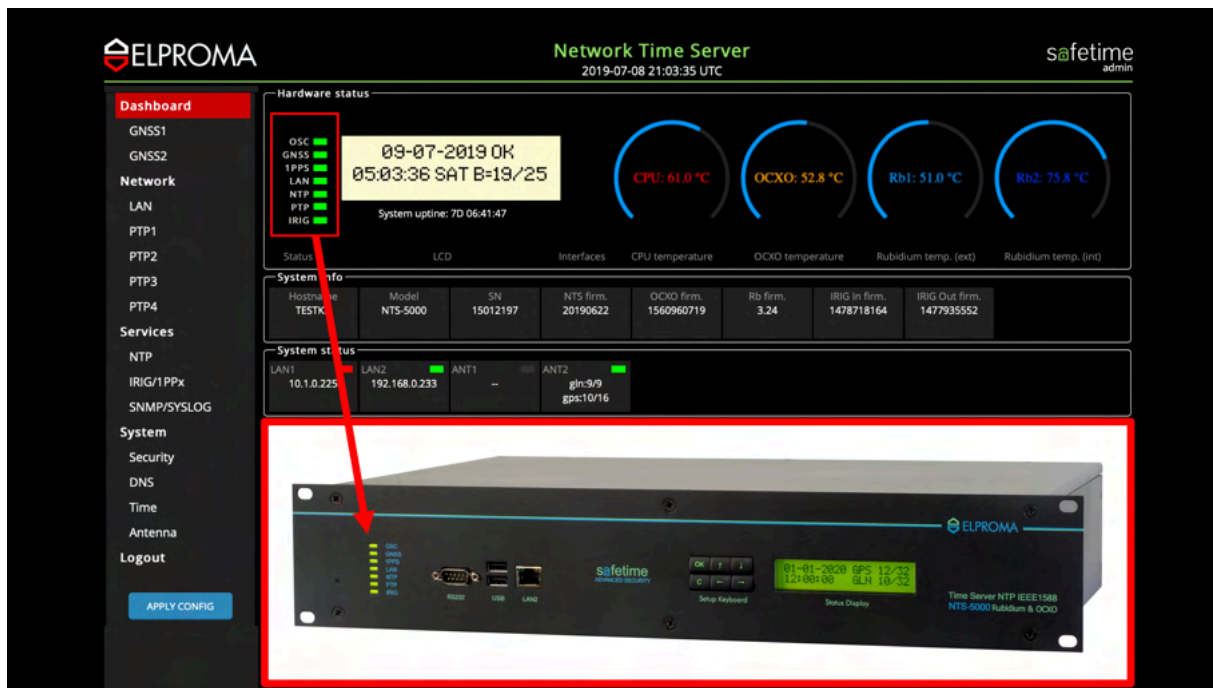

6x LED indicators (from left: OSC, GNSS, PPS, LAN, NTP, PTP, IRIG)



2x 20-character green colour LCD display with date & time, and GNSS satellite basic status

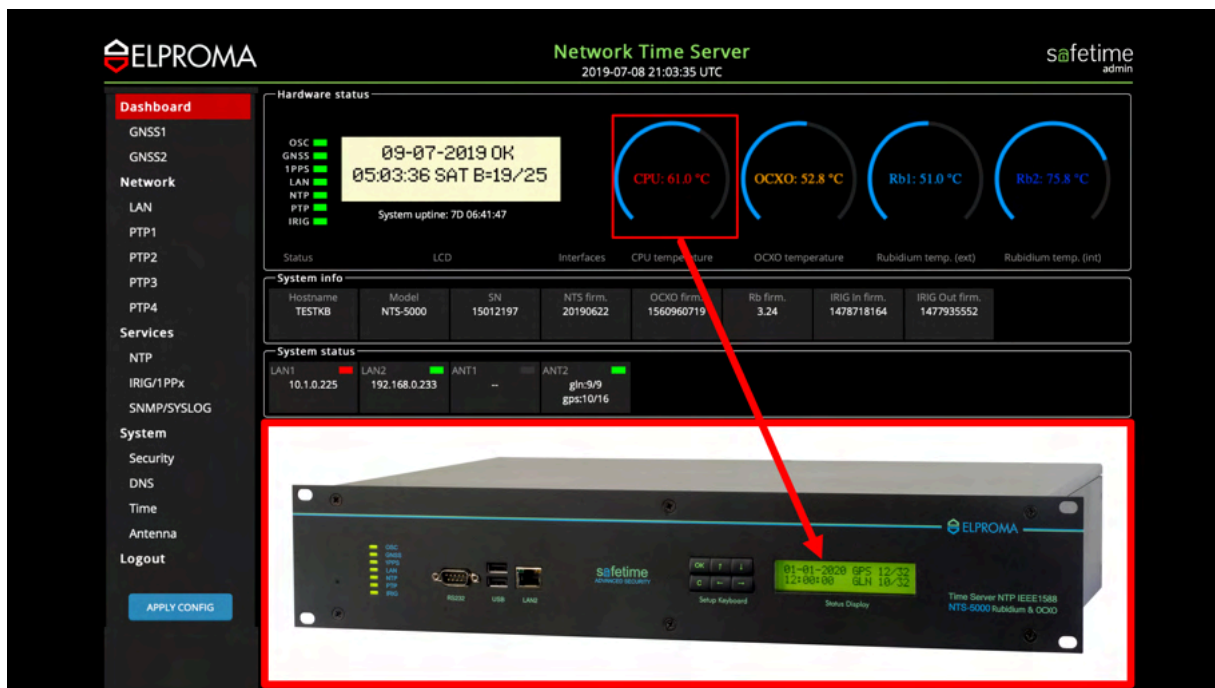

Temperature information (every 5 min. visible on LCD)

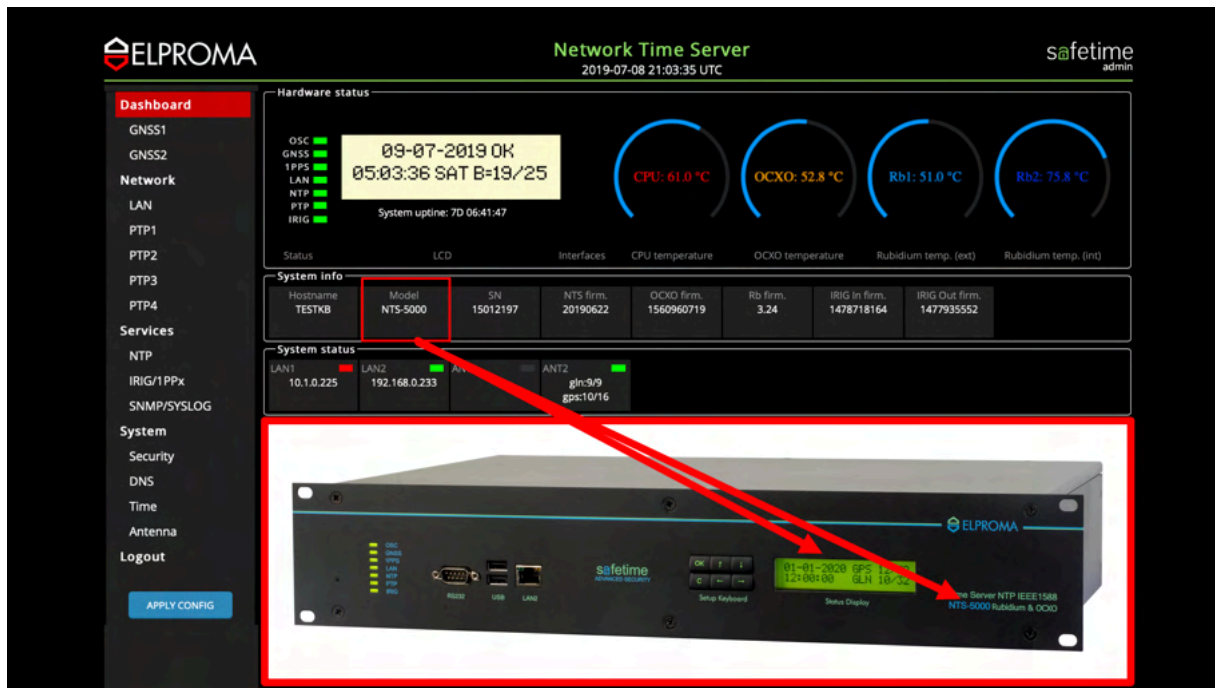

Model (e.g. NTS-5000) available on LCD after power-on. Also located on the right side of front panel



Serial number available on LCD after power-on. Also located on the back-panel S/N sticker

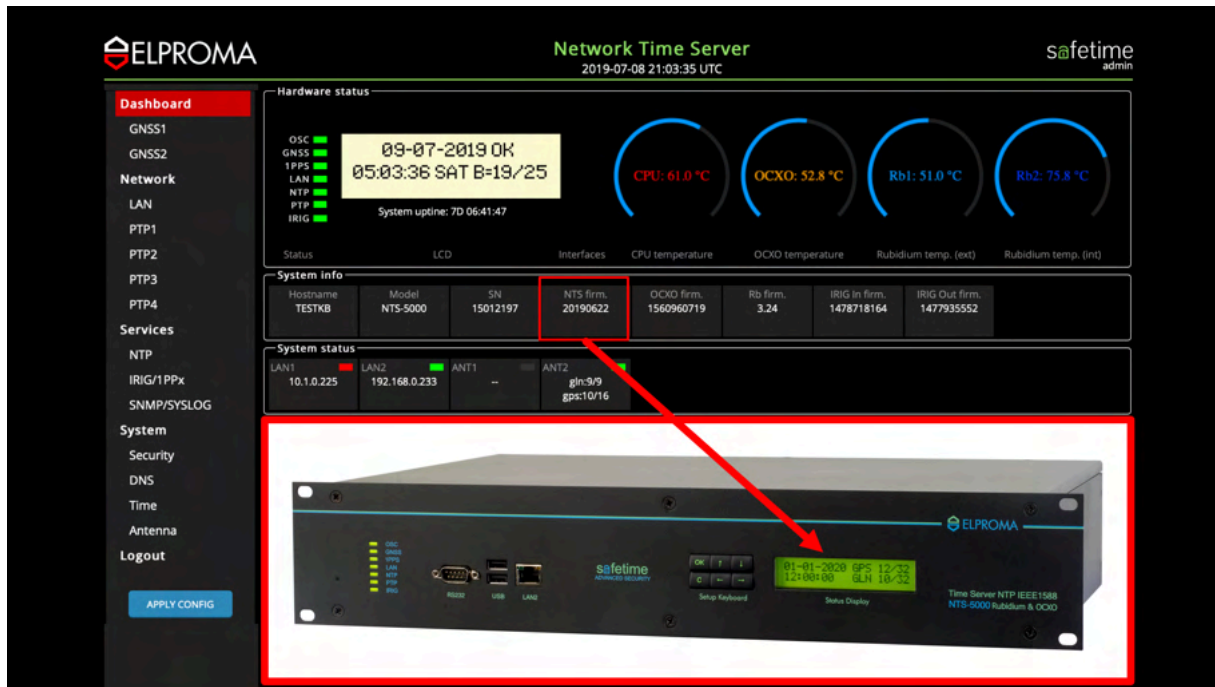

Firmware serial available on LCD after power-on. Also available as KEYBOARD command sequence



IPv4 address & LAN2 front panel LED indicator (flash green when Ethernet network cable connected)



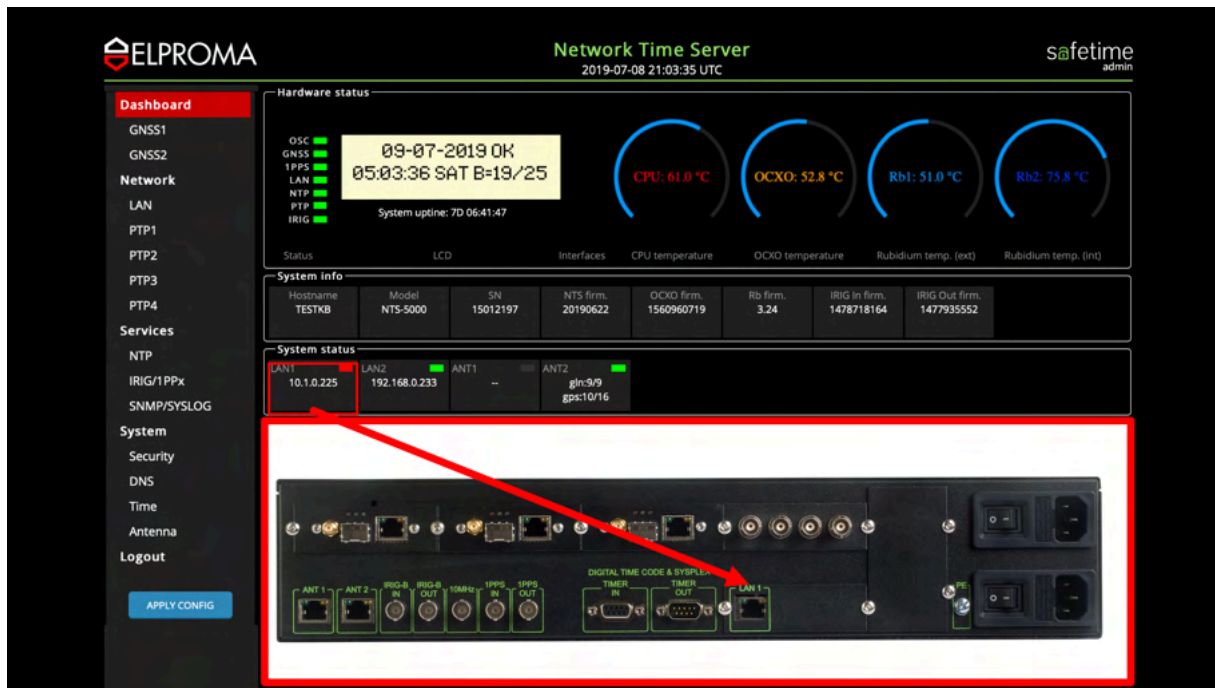

IPv4 address & LAN1 back panel LED indicator (flash red when Ethernet network cable disconnected)

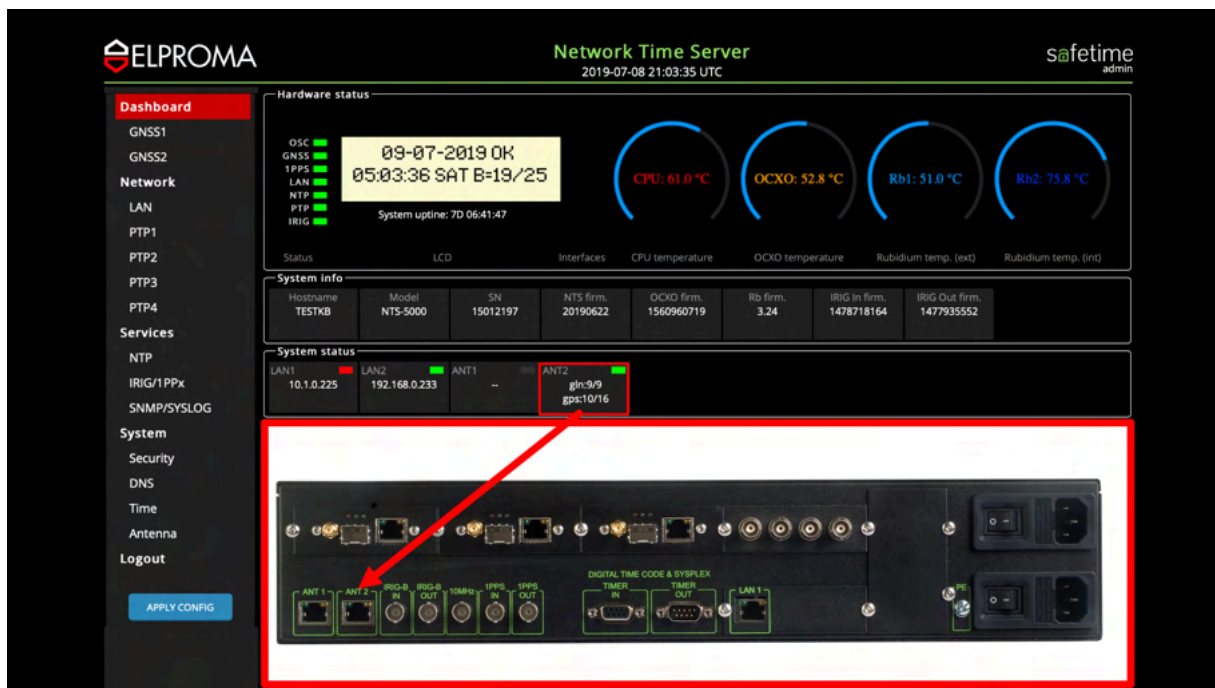

ANT2 back panel LED indicator (blank is NTS-antenna disconnected), and number of SAT is display

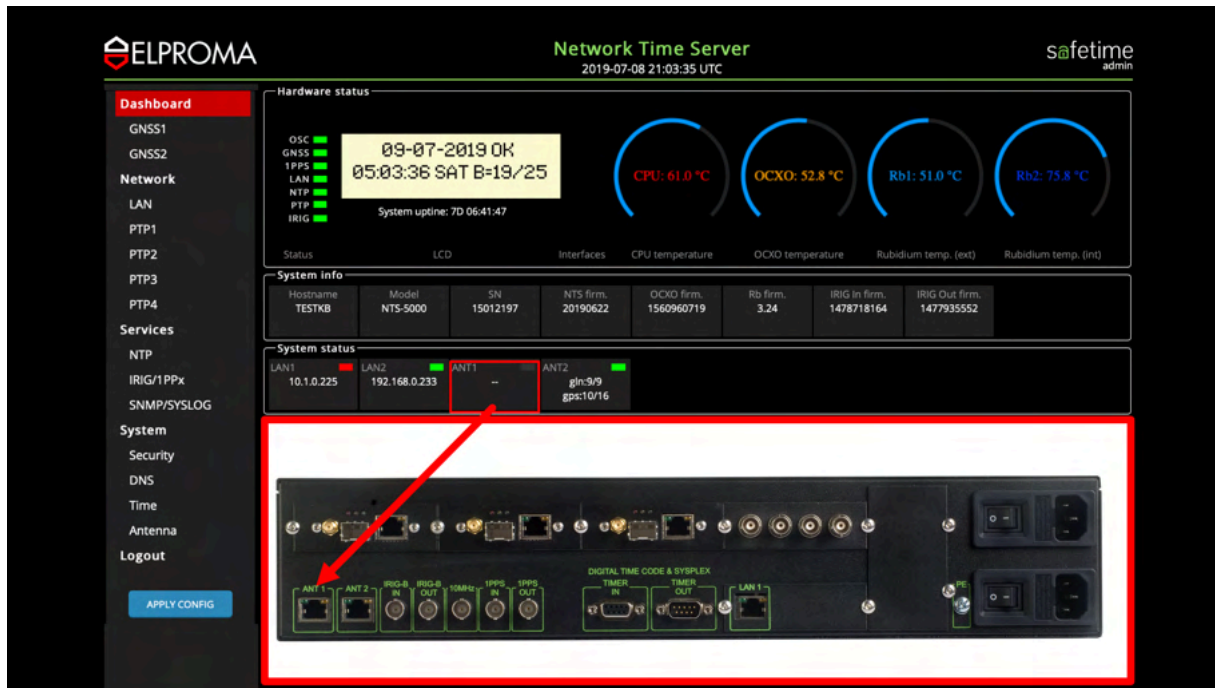

ANT1 back panel LED indicator (blank is NTS-antenna disconnected)

**IMPORTANT!** Please note, when NTS-antenna disconnected also do not forget to disable software setup level interface, otherwise a RED colour LED will flash generating false alarm.

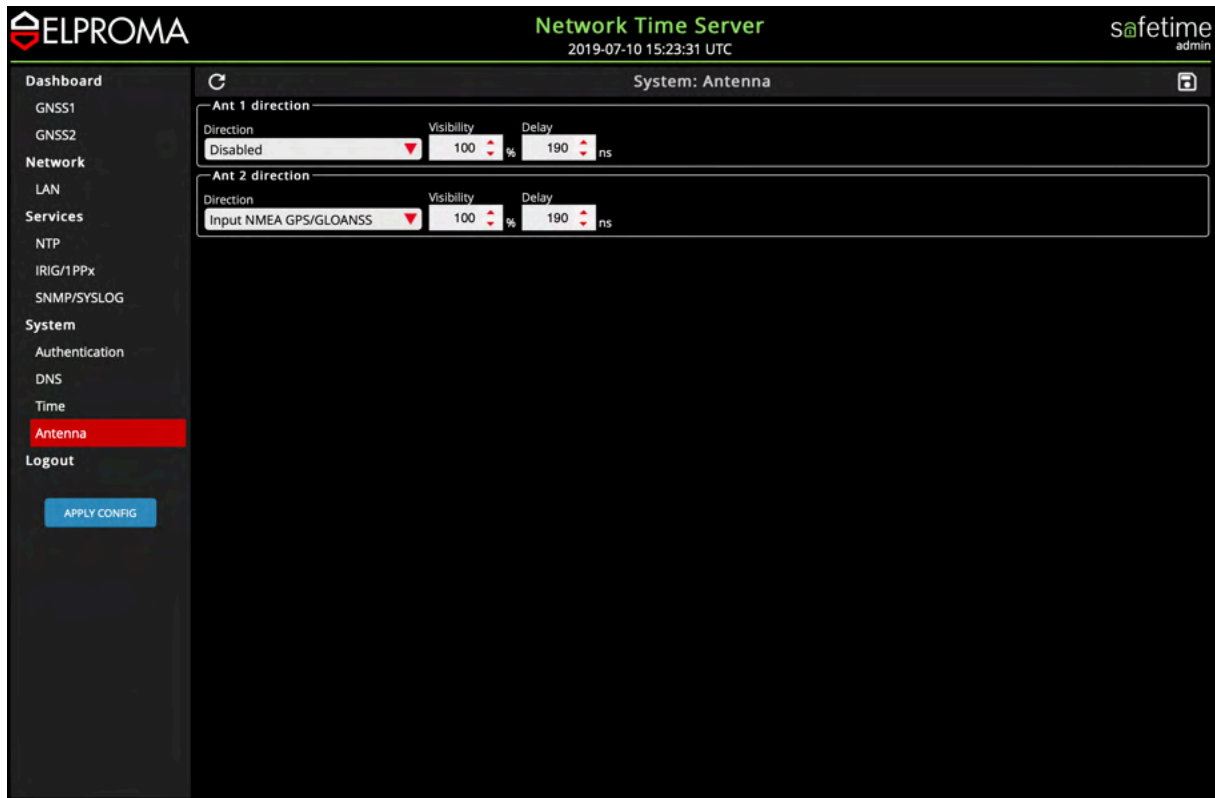

ANT-1 is disabled at Antenna Submenu item, ANT-2 is enabled and set to text NMEA183 mode

# 31. Software WWW – Navigating Menu

Use mouse/pad pointer to select menu item inside web browser:

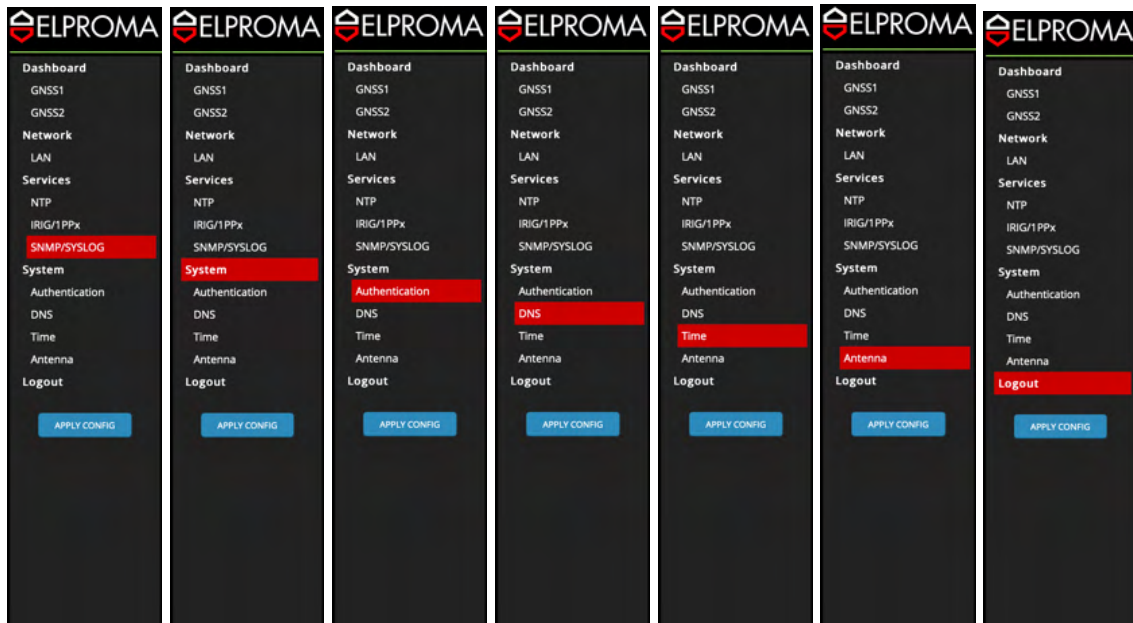
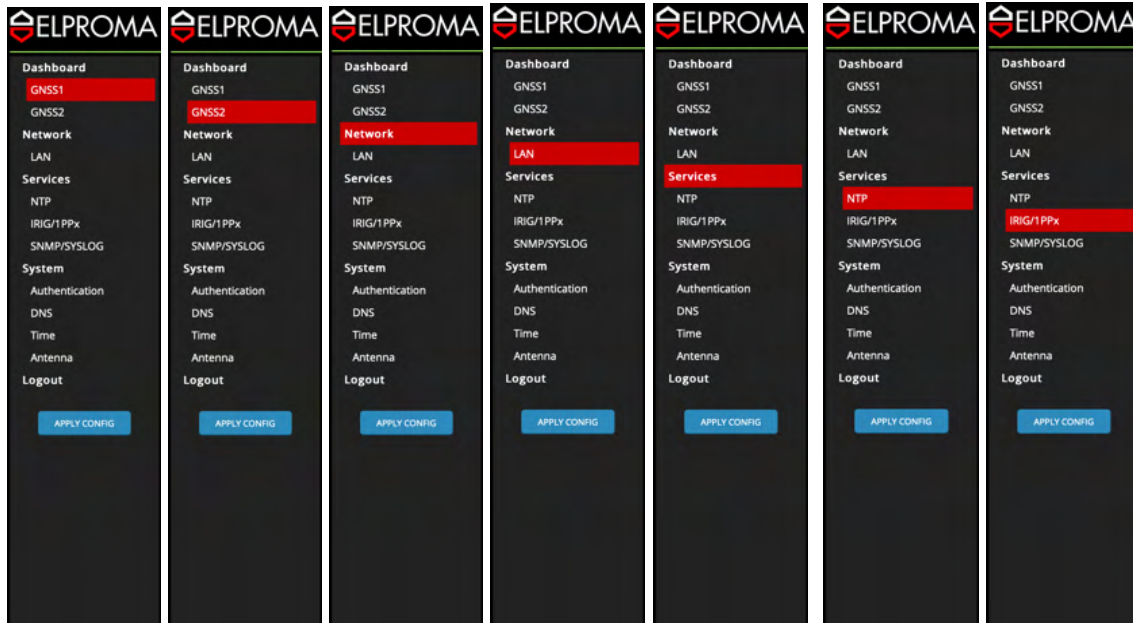

## 32. Software WWW – Saving & Exit Config

Apply changes to make configuration changes effective first:

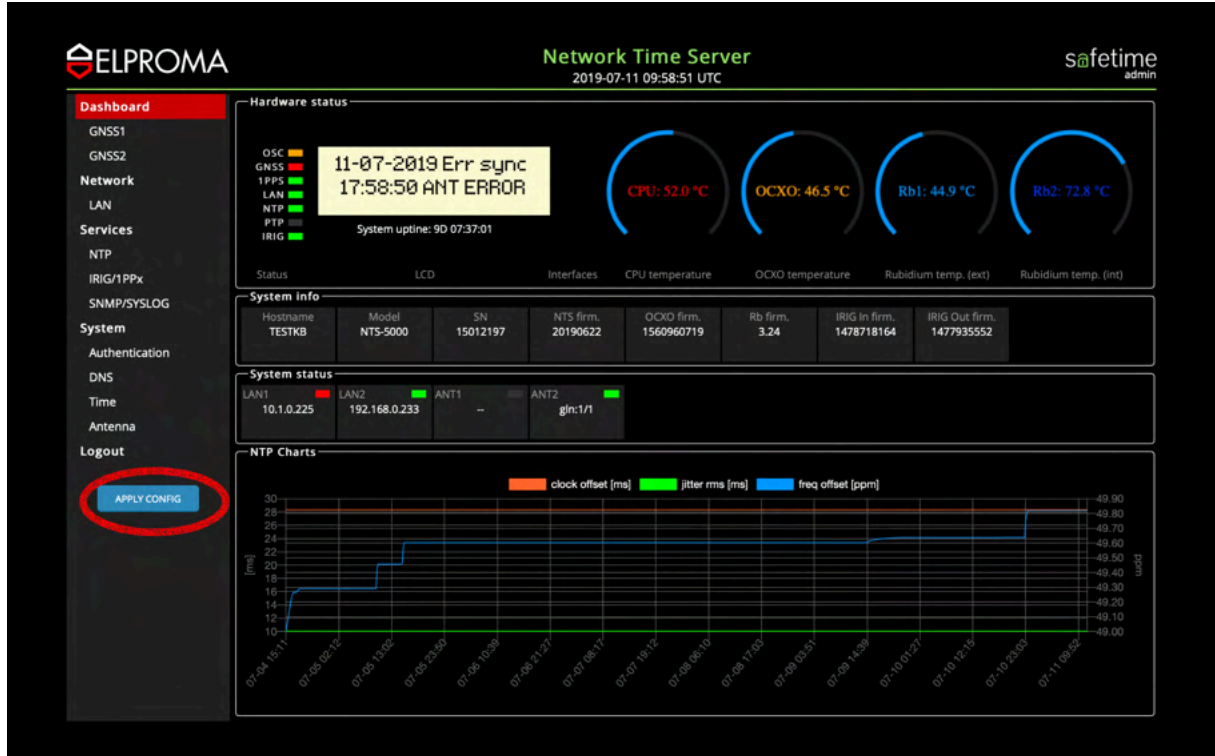

Once you are sure to keep settings permanently do not forget to SAVE it too:

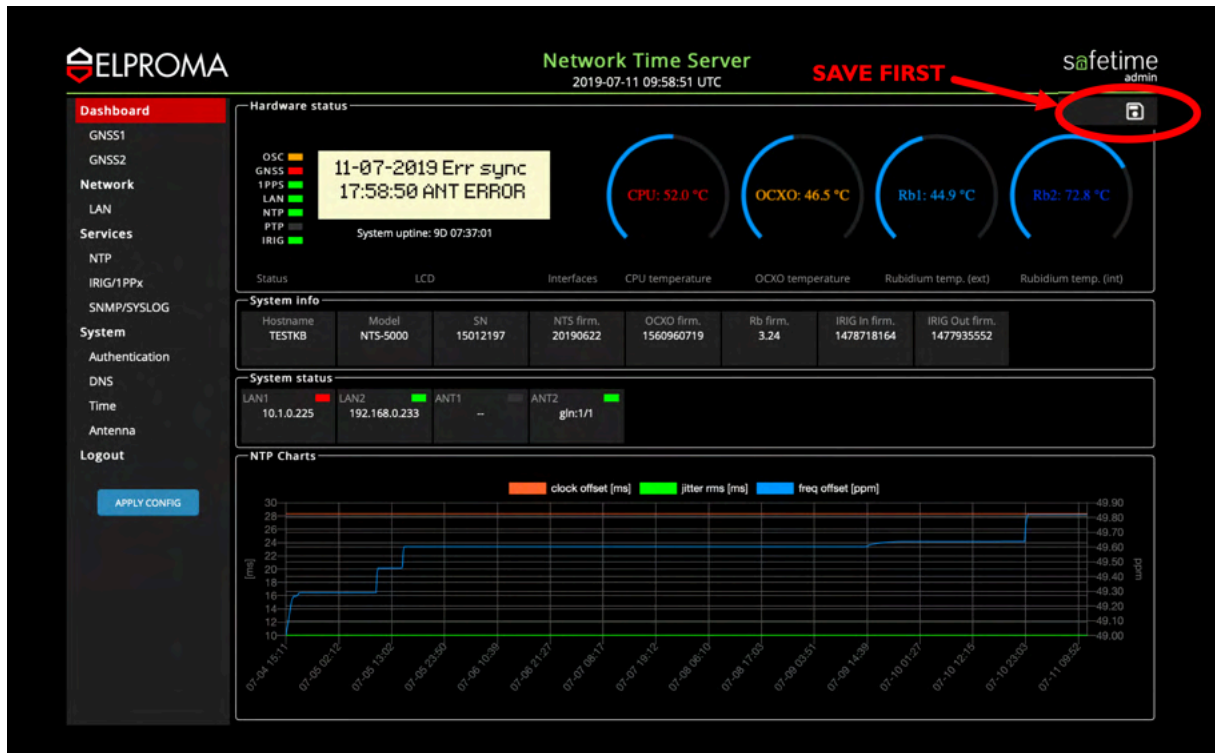

If you want to quit setup, please select LOGOUT from main MENU:

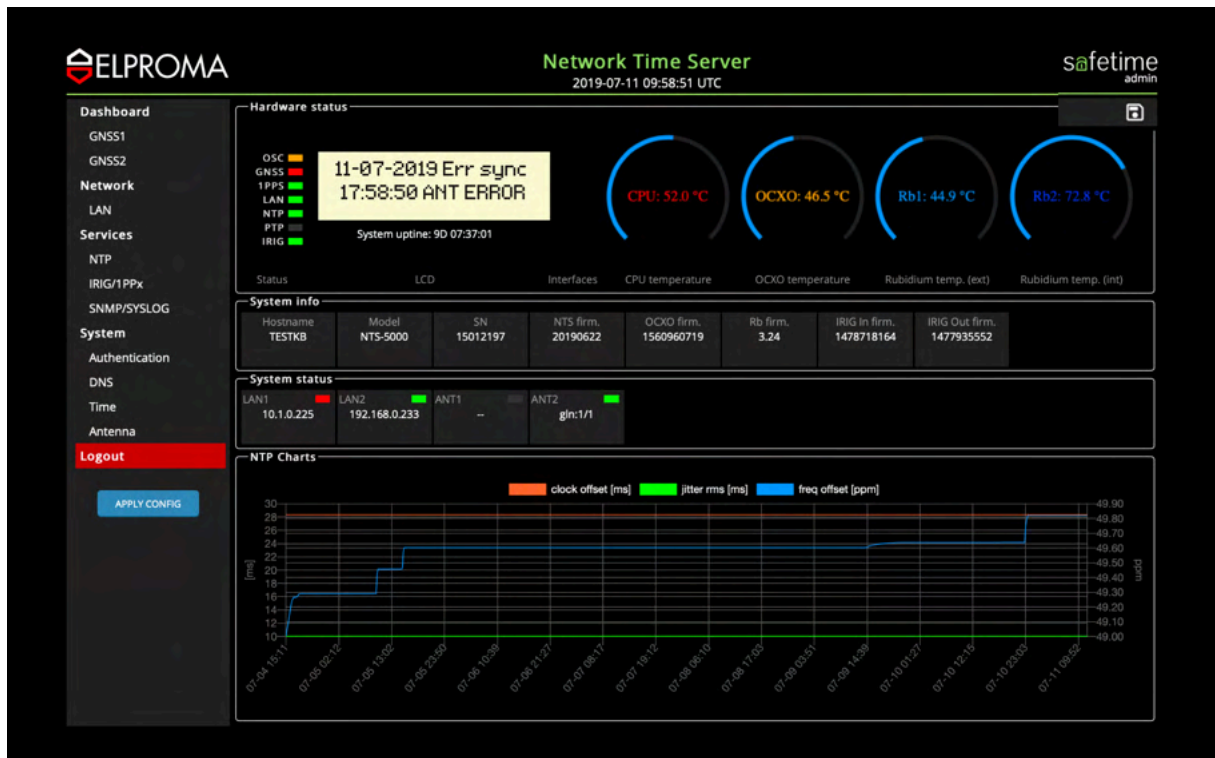

# 33. Software WWW – Setting GNSS & Antenna

## Single NTS-antenna System

The following screen are available if one antenna is connected (e.g. ANT-1):

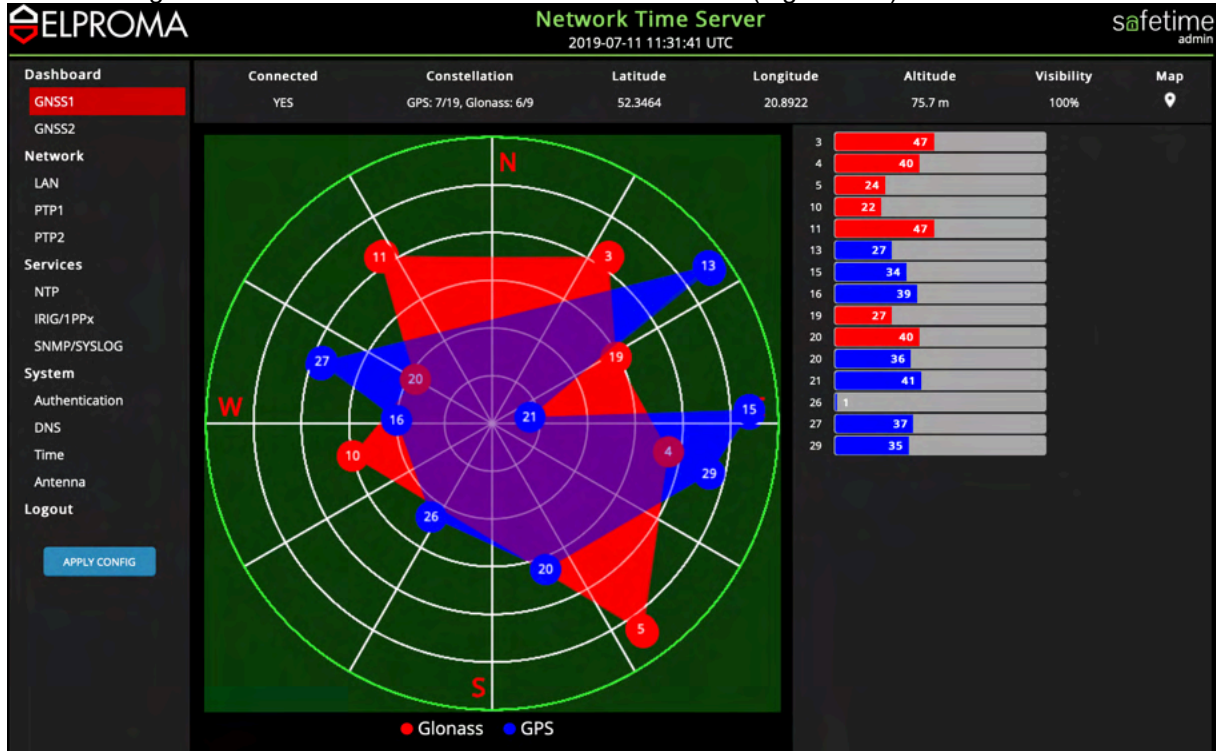

If antenna is not connected (e.g. ANT-2) the following screen appears after selecting GNSS2:

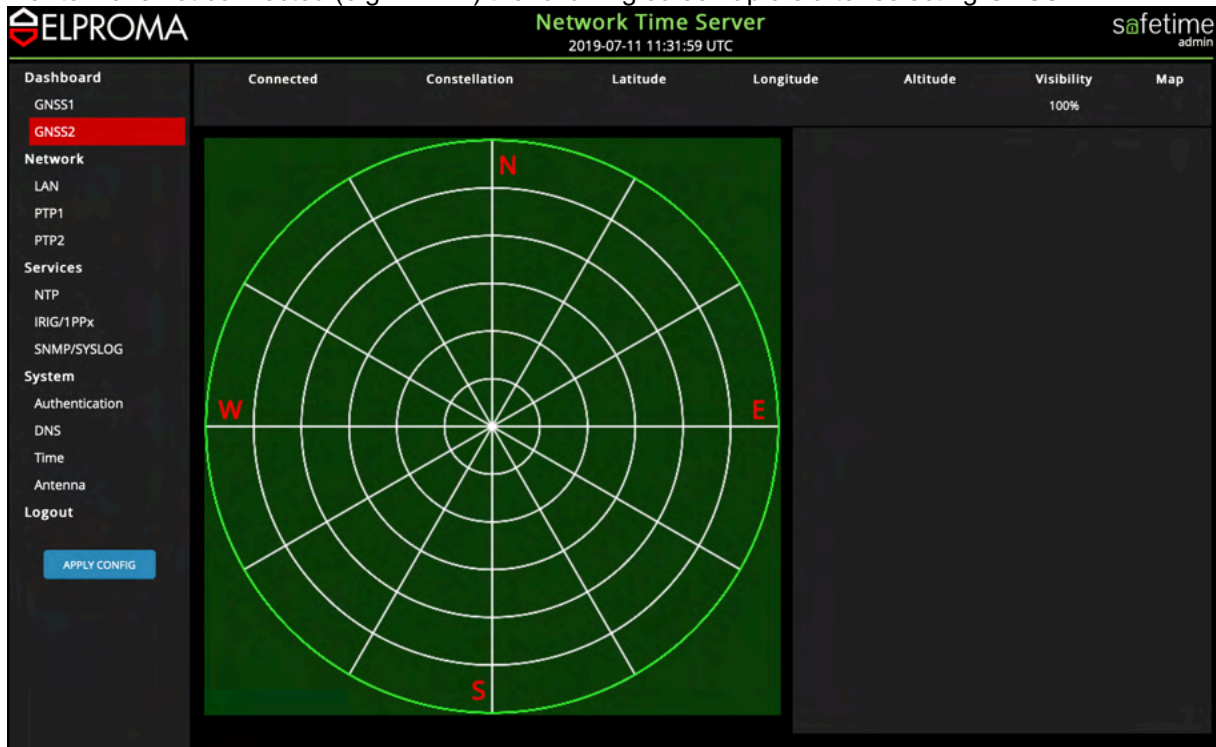

## IMPORTANT NOTE!

In case of using single antenna (ANT-1 or ANT-2), server should keep disabled a not use interface:

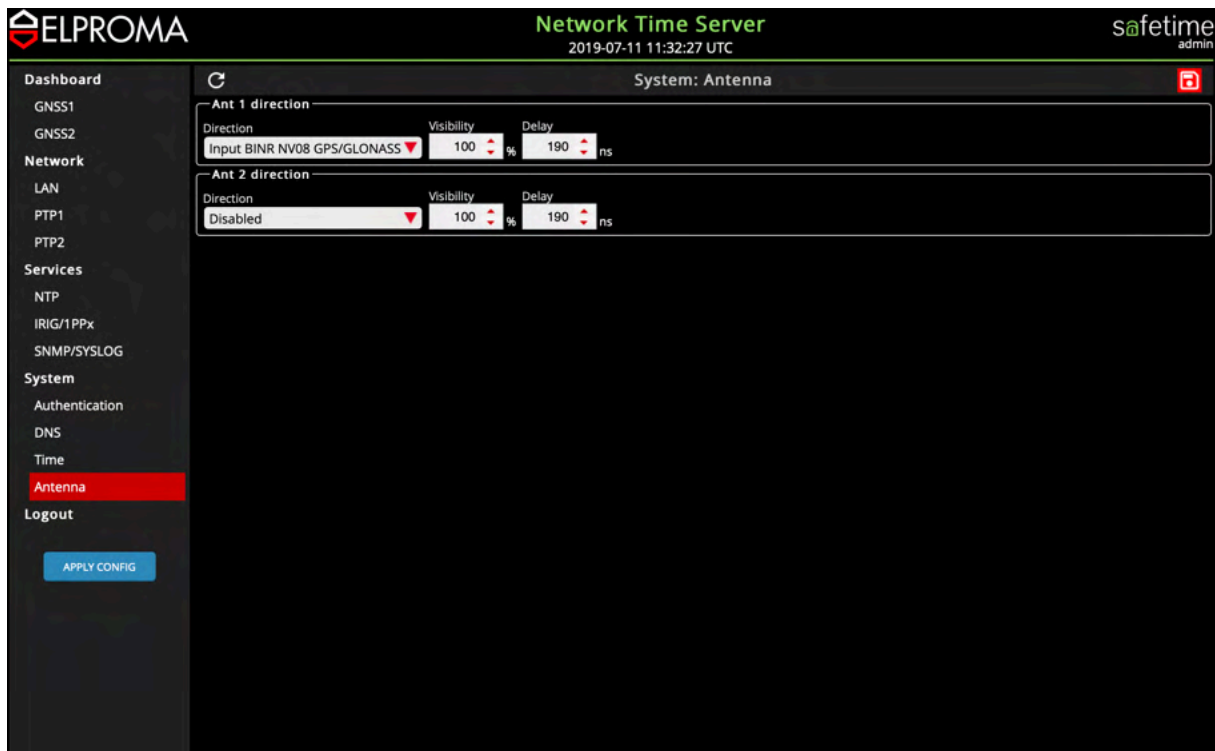

Keeping both antennas enable, when only ANT-1 (or ANT-2) is present, will trigger the front panel GNSS LED flashing RED. This indicates a phantom problem with 2<sup>nd</sup> (not existing) antenna. Please take care to disable not used antenna I/O when only single antenna system is deployed.

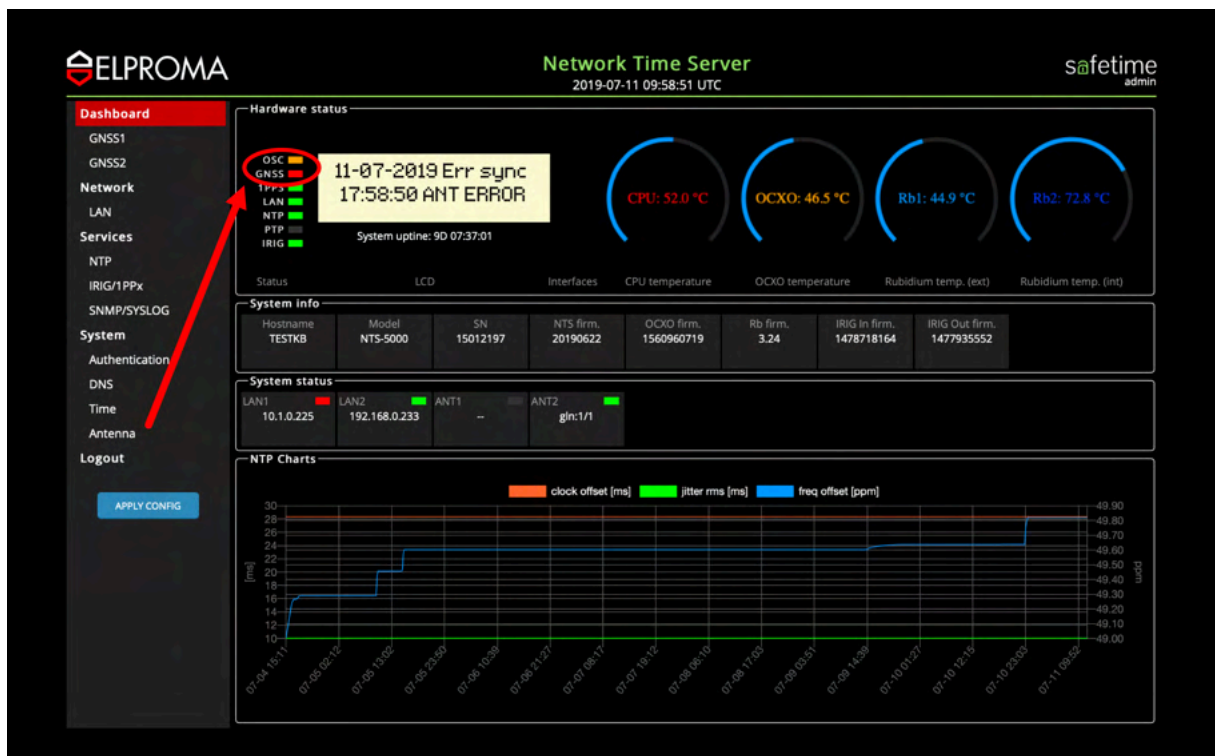

## Redundant NTS-antenna System (2x antenna)

The following looks like screens appear when double antenna system (ANT-1, ANT-2) is in use:

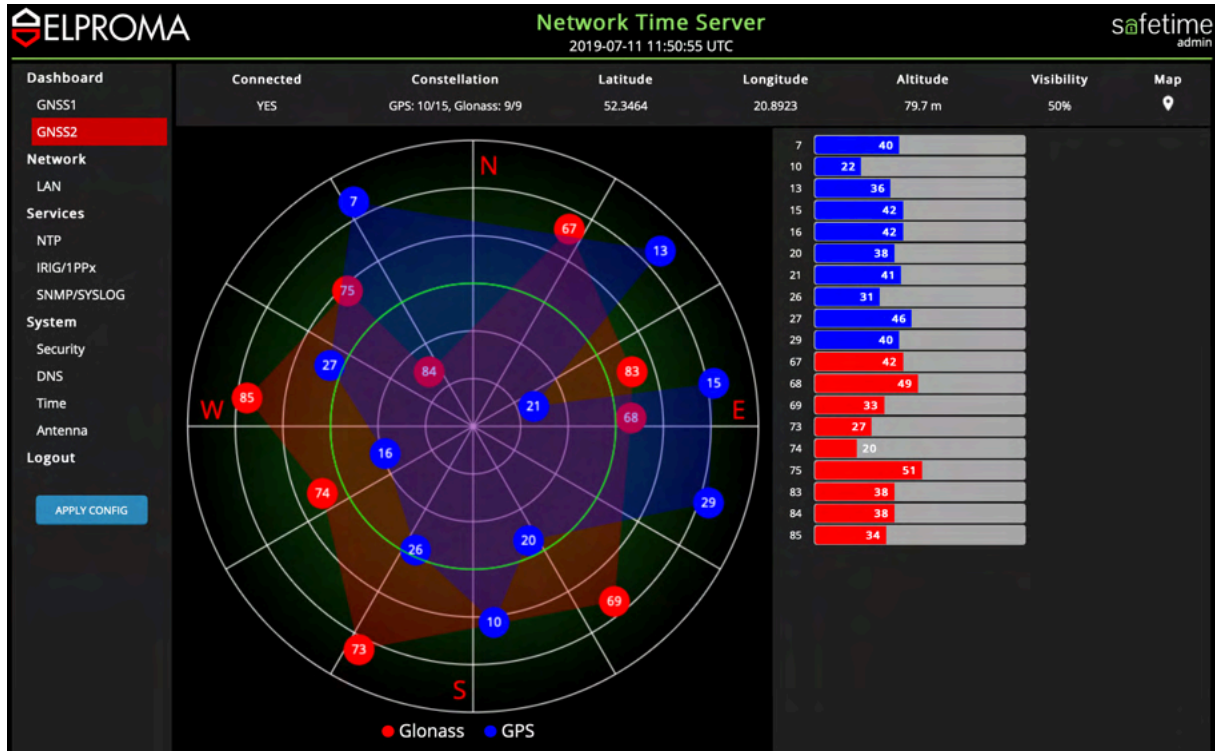
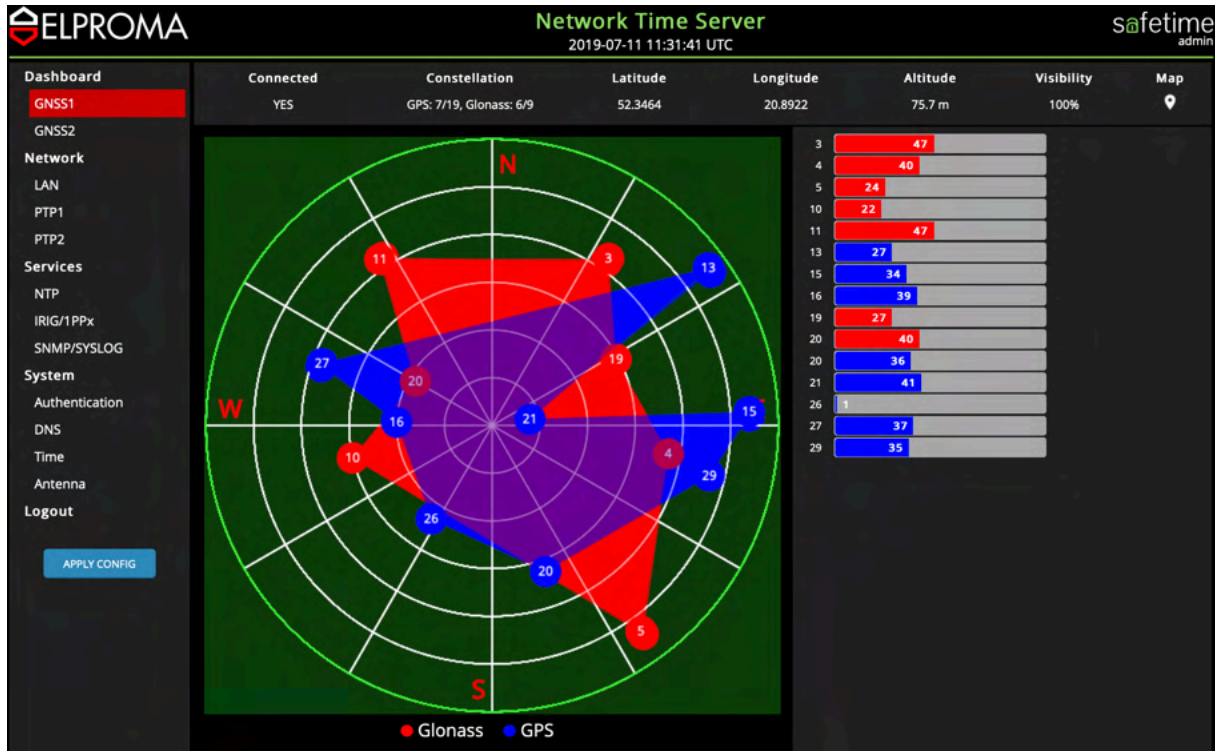



**IMPORTANT NOTE!**

In case of using 2 antennas, please set each of them to different operation mode:  
 E.g. ANT-1 in BINR, and ANT-2 in NMEA mode. Never use the same MODE for both antennas.

The screenshot shows the 'Antenna' configuration page in the ELPROMA Network Time Server interface. The page title is 'Network Time Server' with a timestamp of '2019-07-11 11:55:38 UTC'. The user is logged in as 'safetime admin'. The left sidebar contains a navigation menu with 'Antenna' highlighted. The main content area is titled 'System: Antenna' and contains two sections for antenna configuration:

- Ant 1 direction:** Direction is set to 'Input BINR NV08 GPS/GLONASS', Visibility is 100%, and Delay is 0 ns.
- Ant 2 direction:** Direction is set to 'Input NMEA GPS/GLOANSS', Visibility is 100%, and Delay is 0 ns.

An 'APPLY CONFIG' button is located at the bottom of the configuration area.

The screenshot shows the 'Dashboard' page in the ELPROMA Network Time Server interface. The page title is 'Network Time Server' with a timestamp of '2019-07-10 11:45:55 UTC'. The user is logged in as 'safetime admin'. The left sidebar contains a navigation menu with 'Dashboard' highlighted. The main content area is titled 'Hardware status' and contains several sections:

- Hardware status:** A central display shows 'Onboard voltage [V] +3.39 +5.11'. To the right are four circular gauges: CPU temperature (50.0 °C), OXCO temperature (42.5 °C), Rubidium temp. (ext) (42.5 °C), and Rubidium temp. (int) (71.6 °C). Below these are status indicators for LCD, Interfaces, CPU temperature, OXCO temperature, Rubidium temp. (ext), and Rubidium temp. (int).
- System info:** A table with columns: Hostname (TESTKB), Model (NTS-5000), SN (15012197), NTS firm. (20190622), OXCO firm. (1560960719), Rb firm. (3.24), IRIG In firm. (1478718164), and IRIG Out firm. (1477935552).
- System status:** A table with columns: LAN1 (10.1.0.225), LAN2 (192.168.0.233), ANT1 (checked), ANT2 (checked), gl'n:6/9, and gps:10/16.
- NTP Charts:** A line graph showing clock offset [ms] (orange), jitter rms [ms] (green), and freq offset [ppm] (blue) over time from 07-04 15:11 to 07-08 21:51. The clock offset shows a step-wise increase from approximately 10ms to 28ms. The jitter rms and freq offset remain relatively stable.

An 'APPLY CONFIG' button is located at the bottom of the dashboard area.

## Antenna Modes: In, Out (Emulating NMEA 183)

Each antenna (ANT-1, ANT-2) can operate in INPUT or OUTPUT mode. The output mode emulates antenna in std. GPS NMEA 183 mode, providing ref. time (PPS & ToD) from NTS-x000 to another device. This is very useful when considering over firewall connection between 2 or more timeservers.

In fact this can be one of way to use a public NTP-server to provide alternative backup ref. of time into internal time servers operating inside secured network. This technique can be also be used for remote auditing purpose of internal operating network appliance NTS-x000.

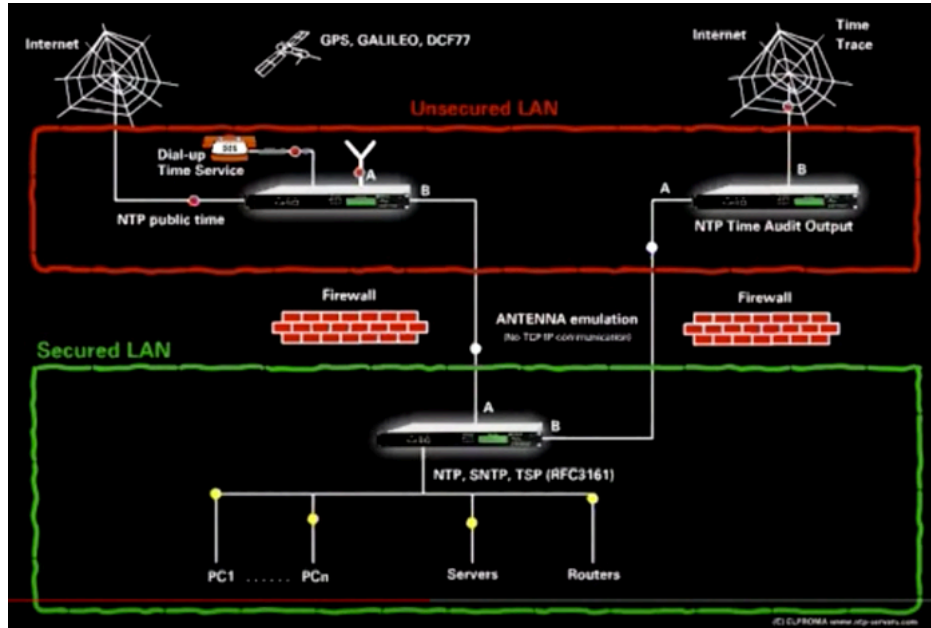

The screenshot shows the web management interface for the Network Time Server. The header includes the ELPROMA logo, the title 'Network Time Server', the date and time '2019-07-11 11:58:49 UTC', and the user 'safetime admin'.  
 - **Left Sidebar:** Contains navigation links for Dashboard, GNSS1, GNSS2, Network, LAN, Services (NTP, IRIG/1PPx, SNMP/SYSLOG), System (Security, DNS, Time), Antenna (highlighted), and Logout. An 'APPLY CONFIG' button is at the bottom.  
 - **Main Content Area:** Titled 'System: Antenna', it displays configuration for two antenna directions:  
 - **Ant 1 direction:** Direction: Output NMEA simulation, Visibility: 100%, Delay: 0 ns.  
 - **Ant 2 direction:** Direction: Output NMEA simulation, Visibility: 100%, Delay: 0 ns.

In above example, the ANT-1 interface will be set to OUTPUT (NMEA183) mode, and the ANT-2 stays operating in INPUT mode (requiring NTS-antenna to be physically connected). Please apply config changes and save your configuration for effective use of new configuration.

Also, considering the INPUT settings, you can choose a different GNSS constellations subset.

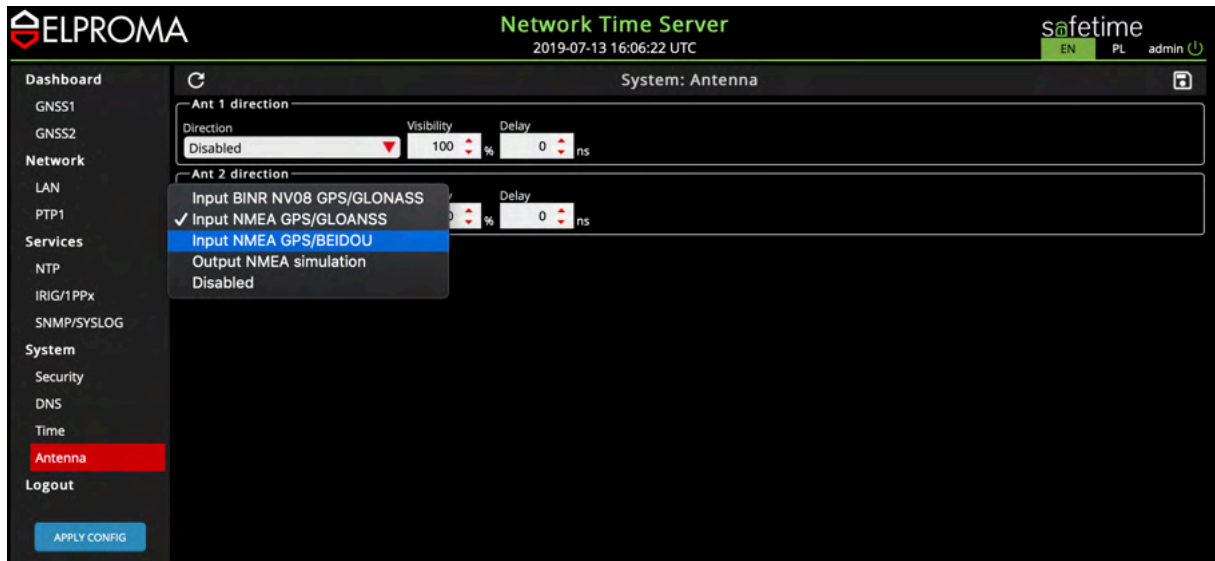

System automatically recognizes the build in GNSS receiver. Depends on type of receiver chip your server is equipped, a new system like GALILEO, IRSS, IRIDIUM can be use too. Some of satellite sub-systems or functionalities are requiring additional licenses to pay separately.

Elproma optionally offers a various of different GNSS receivers supporting GPS, GLONASS, BEIDOU, GALILEO\* o any combination of above systems. We also offer on request a multicarrier receiver supporting frequencies L1/L2/L5:

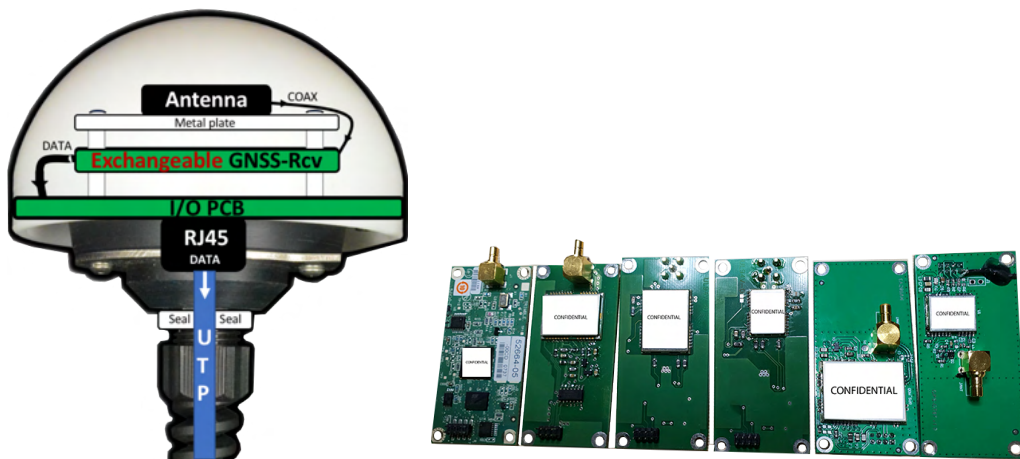

*Exchangeable GNSS modules for NTS-antenna*

Each module basis on different GNSS receiver from different ELPROMA qualified supplier vendor. This functionality is very useful when requirement for new satellite system evolves in time. In such case there are not needs to replace all time-server to new one. The replacing technique is crucial to ensure cybersecurity and “plan B” for unexpected problem like many vendors experience.

## Presenting visibility of GNSS satellites

Sometimes, it is just simply not possible to locate your antenna perfectly to let it view all 360 degree of the sky. In such case, you might like to indicate this fact by setting your own visibility filter on radar. The 100% visibility looks following:

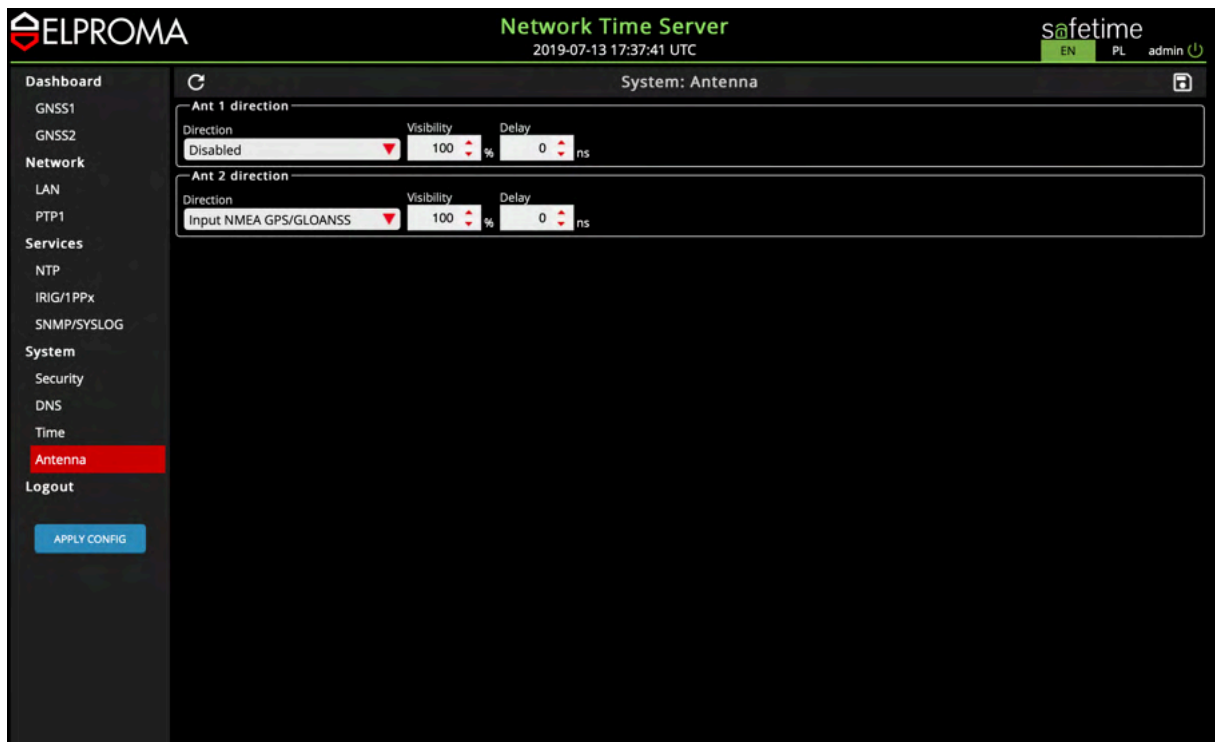
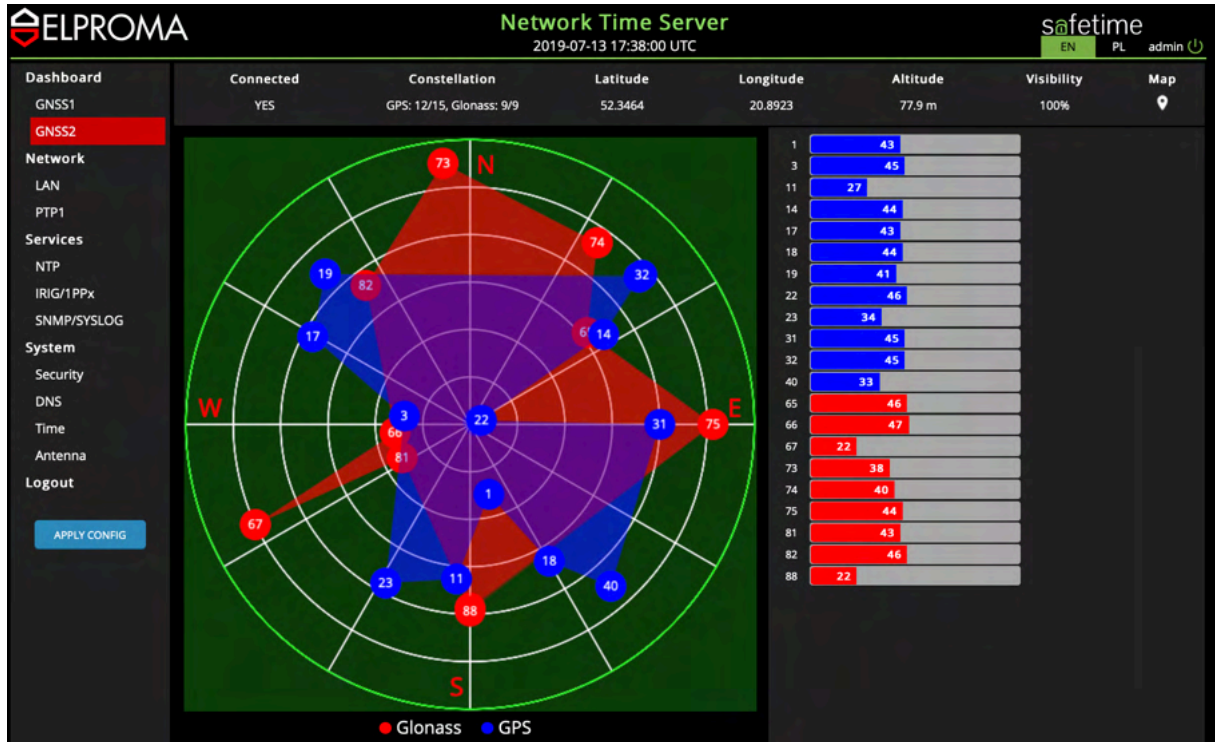

The 50% visibility gives following effect when green colour field indicator moves to centre:

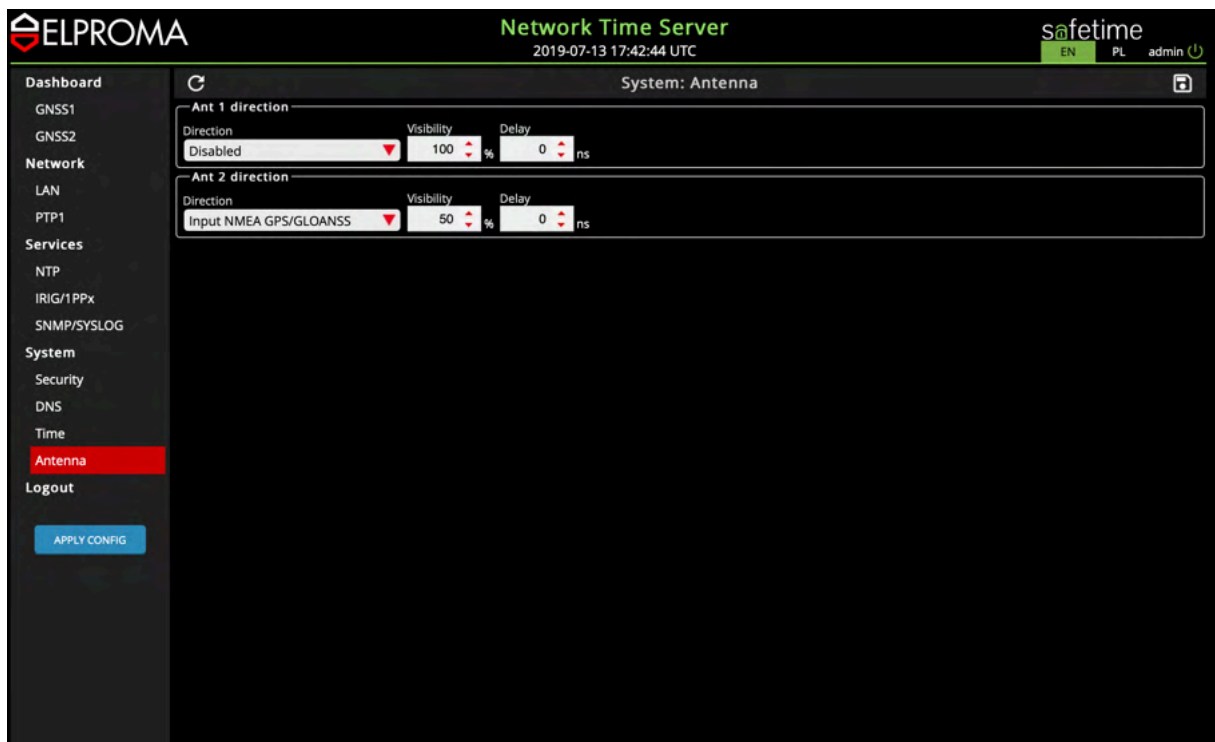
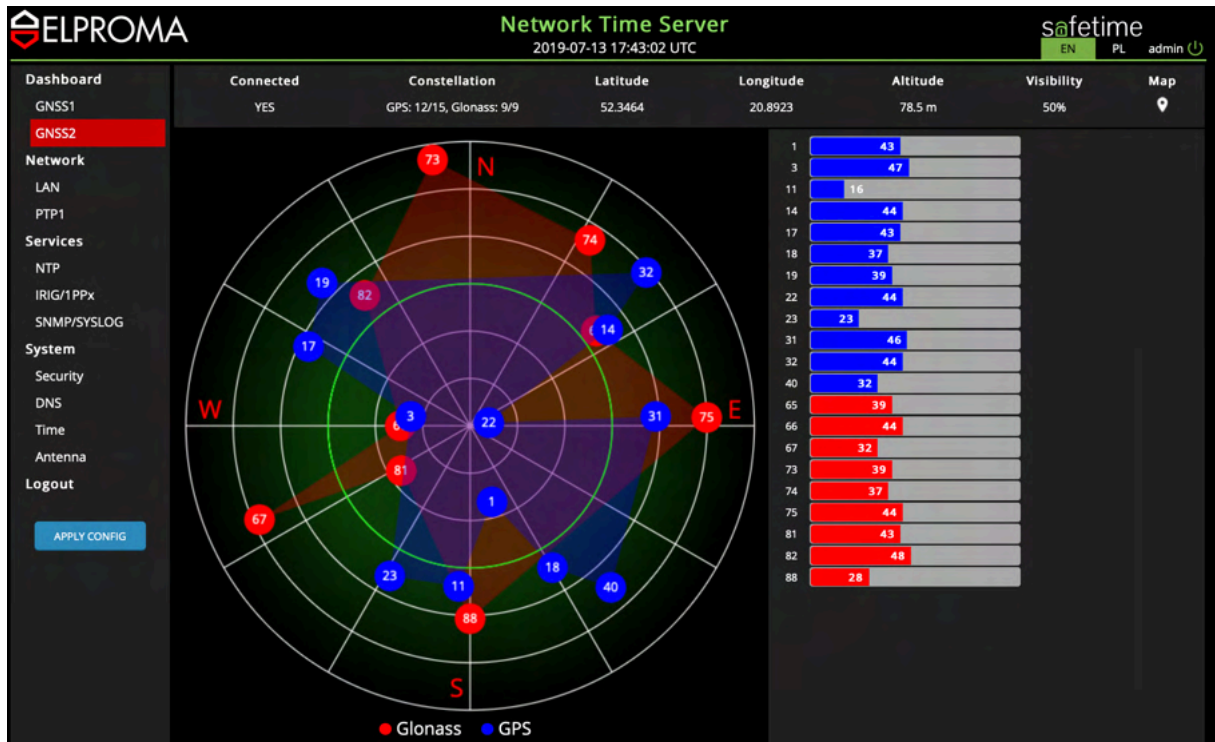

The 25% visibility gives following effect when green colour field indicator moves to centre:

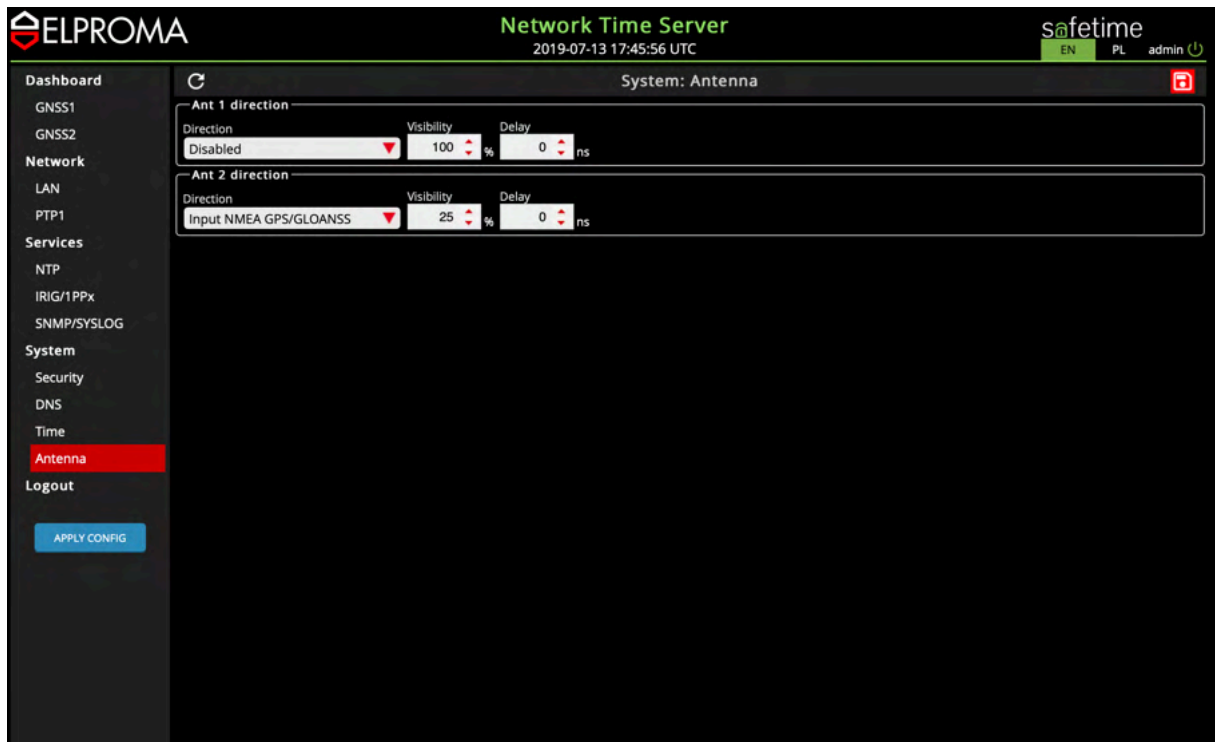
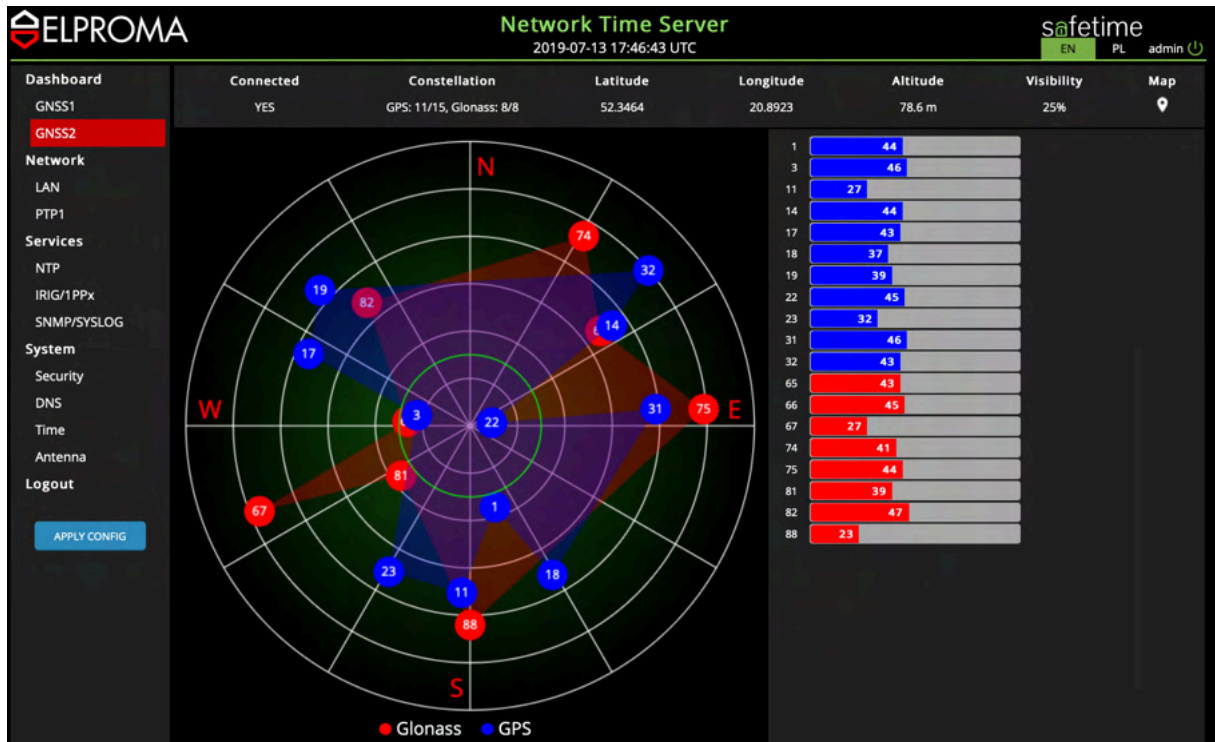

## Compensating cable length delay

**IMPROTANT NOTE!** The cable compensation works only for BIN antenna mode. The NMEA mode currently does not support cable delay compensation.

The NTS-antenna includes built-in GNSS receiver. It computes position and time based on the position. However, the signal must travel through a potentially long UTP (STP) cable before it reaches the NTS-x000 time server. The typical delay for most UTP (STP) cables is 1.5417 ns per foot. For a 30 ft cable, the delay would be  $1.5417 \times 30 = 46.25$  ns. If uncorrected, the NTS-x000 estimates of UTC would be 46.25 ns later than a properly calibrated unit. For the SI metric system please assume a cable delay is 4.5 ns each cable meter. Therefore, for a max. cable length of 700m the compensation delay should be set to 3.15 [us] (microsecond). The final delay compensation you can store at server WWW setup:

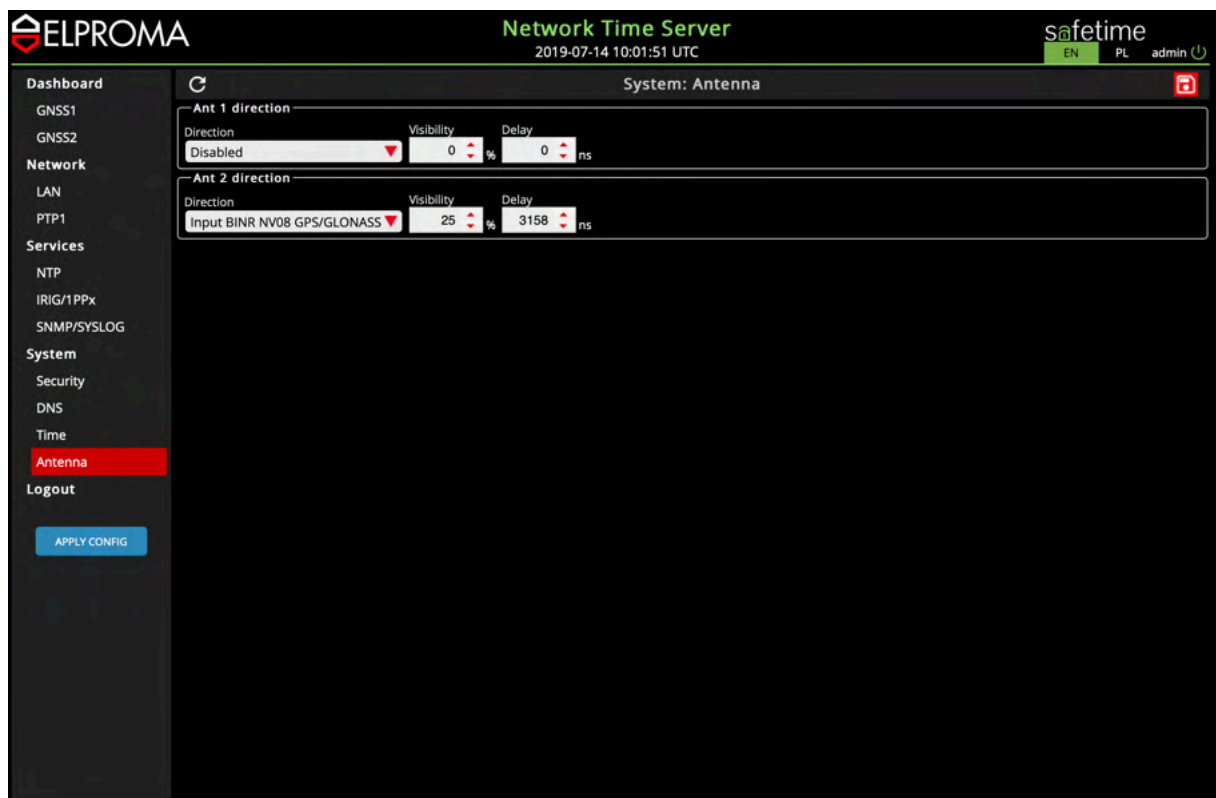

Above example present delay compensation 450ns for 100-meter UTP cat. 5 cable used between NTS-antenna and time server NTS-x000.

NOTE! You will need to save your configuration and apply changes in setting first.

## Setting Synchronization priority of antenna

All Elproma servers support simultaneously both ANT-1 and ANT-2. In fact, it receives simultaneously data from all /O inputs providing ref. sources of UTC time. However, only one reference is taken in time following user-definable PRIORITY TABLE and all other sources stays ready backup.

You can choose using TIME menu item, whatever ANT-1 or ANT-2 will keep priority in synchronization:

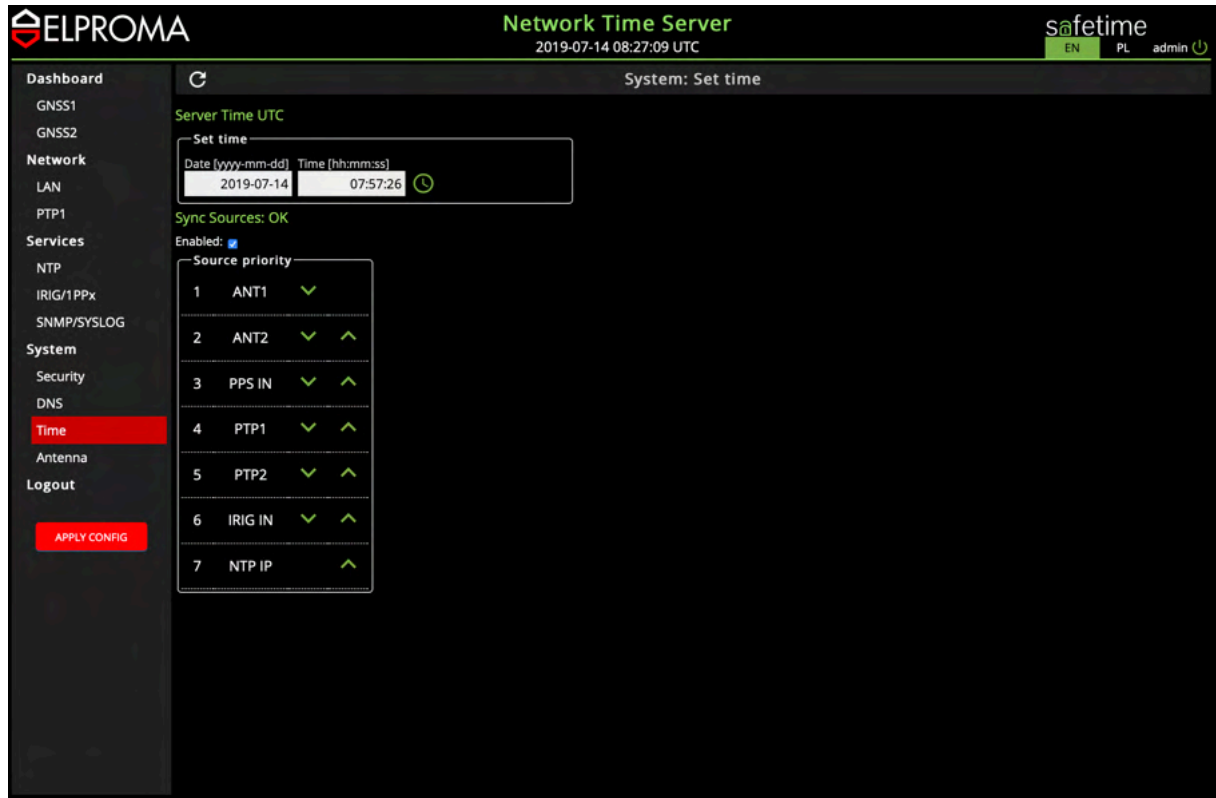

You can swap between antennas priority ANT-1/ANT-2 by clicking green upper/down arrow of each item:

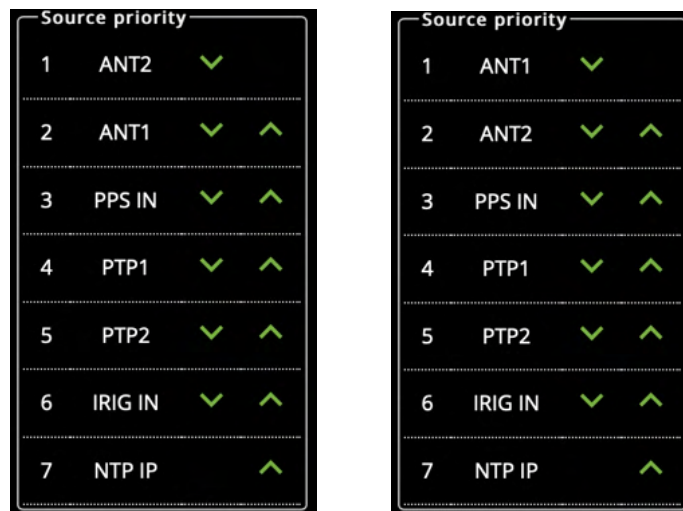

## Monitoring synchronization status of antenna

(please ref. to below chapter)



## 34. Software WWW – Setting Network

To configure network interface please connect your time server to PC using LAN1-LAN2. The NETWORK menu presents all sync. resources with its current priority and status. The 1<sup>st</sup> column marks “o”, “\*” indicates current source of time. Other candidates are marked “+” or “-“. Table presents also other data useful to examine performance and status of syncing.

The screenshot shows the 'Network Time Server' web interface. The top navigation bar includes the ELPROMA logo, the title 'Network Time Server', the date and time '2019-07-14 09:20:51 UTC', and the safetime logo with language options (EN, PL) and a user profile (admin). A left sidebar contains a menu with items like Dashboard, GNSS1, GNSS2, Network (highlighted), LAN, PTP1, Services, NTP, IRIG/1PPx, SNMP/SYSLOG, System, Security, DNS, Time, Antenna, and Logout. The main content area is titled 'Network statistics' and contains two tables.

**Network statistics - NTPQ**

Status	Remote	Refid	Delay [ms]	Offset [ms]	Jitter [ms]	Pool	Reach	When
	22.0.0.0	BCST	0.000	0.000	0.004	1024	0	0
	0.0.0.0	BCST	0.000	0.000	0.004	1024	0	0
	192.168.1.3	INIT	0.000	0.000	0.000	8	0	0
o	127.127.20.1	ANT2	0.000	-0.001	0.004	8	0377	2
	127.127.22.2	EXT	0.000	0.000	0.000	8	0	0
*	127.127.28.3	RB	0.000	0.005	0.004	8	0377	1
+	127.127.28.0	OCXO	0.000	0.015	0.004	8	0377	8
	127.127.28.4	IRIG	0.000	0.000	0.000	8	0	0
	127.127.28.5	PTP1	0.000	0.000	0.000	8	0	0
	127.127.4.0	WWVB	0.000	0.000	0.000	64	0	0
	192.168.1.2	INIT	0.000	0.000	0.000	8	0	0

**Network statistics - PTP**

PTP card	Mode	Clock state	Clock sync	TOD in	PPS in	UTC offset	Time PTP	Time ref	Time UTC
1									

If your server is equipped with Expander 1-4 PTP IEEE1588 cards, the bottom part of screen includes a list expander cards and its data:

The screenshot shows the 'Network Time Server' web interface. The top navigation bar includes the ELPROMA logo, the title 'Network Time Server', the date and time '2019-07-14 09:29:53 UTC', and the safetime logo with language options (admin). A left sidebar contains a menu with items like Dashboard, GNSS1, GNSS2, Network (highlighted), LAN, PTP1, PTP2, PTP3, PTP4, Services, NTP, IRIG/1PPx, SNMP/SYSLOG, System, Security, DNS, Time, Antenna, and Logout. The main content area is titled 'Network statistics' and contains two tables.

**Network statistics - NTPQ**

Status	Remote	Refid	Delay [ms]	Offset [ms]	Jitter [ms]	Poll	Reach	When
	127.127.20.0	ANT1	0.000	0.000	0.000	8	0	0
	127.127.28.2	ANT2	0.000	0.000	0.000	8	0	0
	127.127.22.2	EXT	0.000	0.000	0.000	8	0	0
	127.127.28.3	RB	0.000	0.000	0.000	8	0	0
	127.127.28.0	OCXO	0.000	0.000	0.000	8	0	0
	127.127.28.4	IRIG	0.000	0.000	0.000	8	0	0
	127.127.4.0	WWVB	0.000	0.000	0.000	64	0	0

**Network statistics - PTP**

PTP card	Mode	Clock state	Clock sync	TOD in	PPS in	UTC offset	Time PTP	Time Ref	Time UTC
1	MASTER	FREE	NO	Unstable	Unstable	37	2019-07-14 09:30:30	2019-07-14 09:29:53	2019-07-14 09:29:53
2	MASTER	FREE	NO	Unstable	Unstable	37	2019-07-14 09:30:30	2019-07-14 09:29:53	2019-07-14 09:29:53
3	MASTER	FREE	NO	Unstable	Unstable	37	2019-07-14 09:30:30	2019-07-14 09:29:53	2019-07-14 09:29:53
4	MASTER	FREE	NO	Unstable	Unstable	37	2019-07-14 09:30:30	2019-07-14 09:29:53	2019-07-14 09:29:53

## LAN1-LAN2 (std.)

### IMPORTANT NOTE!

Configuring Time Server is requiring exclusive access by single interface at time.

Only single LAN in time can include GATEWAY (LAN1 or LAN2).

LAN1-LAN2 interfaces are 10/100Mbps and they support software stamping NTP and PTP.

The screenshot shows the 'LAN interfaces' configuration page in the Network Time Server web interface. The interface is divided into two sections: LAN1 and LAN2. Each section includes an 'Interface' configuration area with fields for 'Enabled', 'IPv4 address', 'IPv4 mask', 'IPv4 gateway', 'IPv6 address', and 'IPv6 prefix'. Below the interface settings are 'NTP Broadcast' and 'NTP Multicast' sections, each with 'Enable', 'Range', 'Enable encryption', and 'MD5 key ID' fields. At the bottom of each section is a 'Services' row with checkboxes for NTP, Telnet, SSH, HTTP, HTTPS, SNMP, and PTP. The LAN1 interface is currently selected and highlighted in red in the left sidebar.

## LAN3-LAN10 (optional Expander 1-4 for NTS-5000/TC)

### IMPORTANT NOTE!

Configuring LAN3-LAN10 is only possible via LAN1 or LAN2 interface at time.

Each LAN can include own GATEWAY (LAN3- LAN10).

LAN3-LAN10 interfaces are 1GE and they support hardware stamping PTP IEEE1588

The screenshot shows the 'PTP interface 1' configuration page in the Network Time Server web interface. The interface is divided into several sections: 'Profile' with dropdowns for 'Custom', 'MAC mode', and 'Mode'; 'IP Eth' and 'IP SFP' sections with fields for IP, Mask, and Gateway; 'Clock PTP' section with fields for Description, Two step, Priority 1, Priority 2, Domain, Class, Accuracy, and Variance; 'Port PTP' section with fields for Mechanism, Protocol, Compatibility, Timeout [s], Unicast, Asymetry [s], Sync, Delay, Pdelay, Announce, Receipt, and DSCP; and 'SNTP Server' and 'IP Master Node' sections with fields for Enable, Mode, Poll, UTC offset enable, Offset, and IP address. The left sidebar shows 'PTP1' selected and highlighted in red.

## PTP IEEE1588 configuration LAN3-LAN10

NTS-5000 and NTS-TC can be equipped with additional network interfaces, supporting hardware stamping PTP IEEE1588. There are max. 4x NIC (Expander 1-4 cards), each includes 2x LAN (1GE) supported by Rj45 and SFP interface.



**Expander 1-2 can operate both: grandmaster & slave PTP IEEE1588.** Expander 3-4 are only able to operate as grandmaster. All cards are automatically recognized by NTS-5000/NTS-TC system and added to main menu. Master/Slave is set for all expander, so if you choose to operate Expander1 card slave, both LAN3 and LAN4 will operate slave too. To choose MASTER or SLAVE mode (LAN3-LAN6) select from profile menu:

**ELPROMA** Network Time Server 2019-07-14 10:59:39 UTC safetime admin

PTP interface 1

PTP1 (/dev/ptp1)

Profile

MAC mode: Custom Mode:  Master  Slave

IP Eth

IP	Mask	Gateway	IP SFP	Mask	Gateway
192.168.1.211	255.255.255.0	0.0.0.0	192.168.1.211	255.255.255.0	0.0.0.0

Clock PTP

Description	Two step	Priority 1	Priority 2	Domain	Class	Accuracy	Variance
NTSPTP1	<input checked="" type="checkbox"/>	128	128	0	6	33	65535

Clock Quality

Port PTP

Mechanism	Protocol	Compatibility	Timeout [s]	Unicast	Asymetry [s]	Sync	Delay	Pdelay	Announce	Receipt	DSCP
E2E	UDP	Off	0	Disable	0	0	0	0	0	0	0

SNTP Server

Enable	Mode	Poll	Time	UTC offset enable	Offset	IP Master Node	IP address
<input checked="" type="checkbox"/>	Mixed	0	<input checked="" type="checkbox"/>	0	0	<input checked="" type="checkbox"/>	0.0.0.0

APPLY CONFIG

Choose specific interface ETH or SFP you want to configure for each Expander 1-4 car: PTP1.. PTP4.

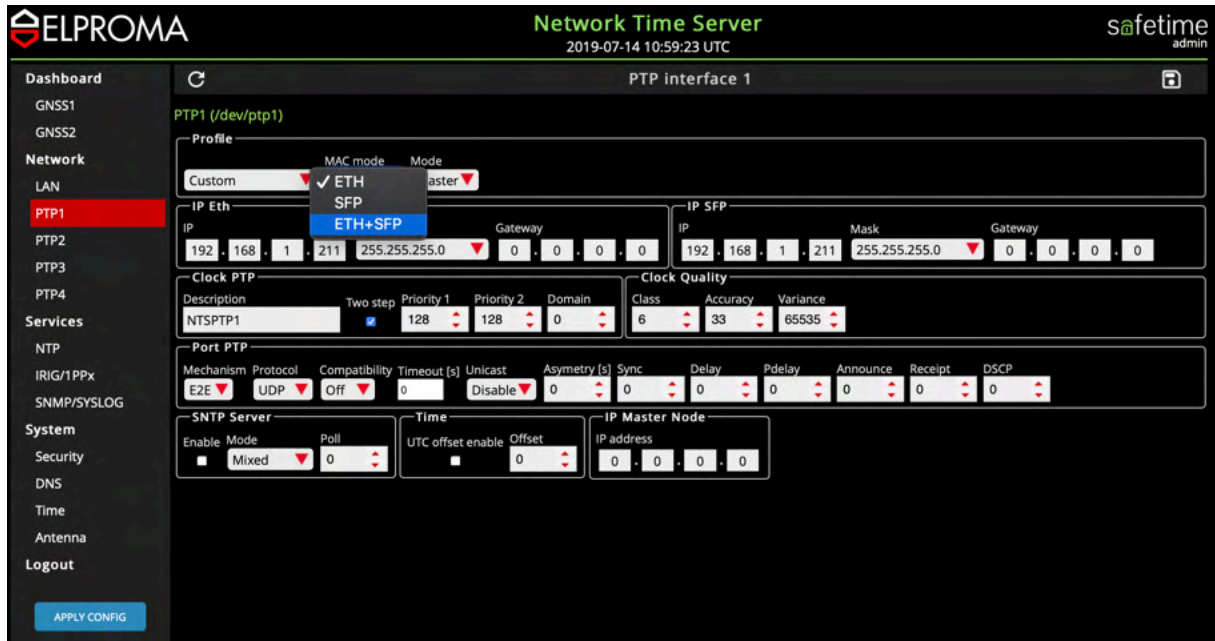

Choose predefined PTP IEEE1588: 2008 profiles from menu or define our own custom one:

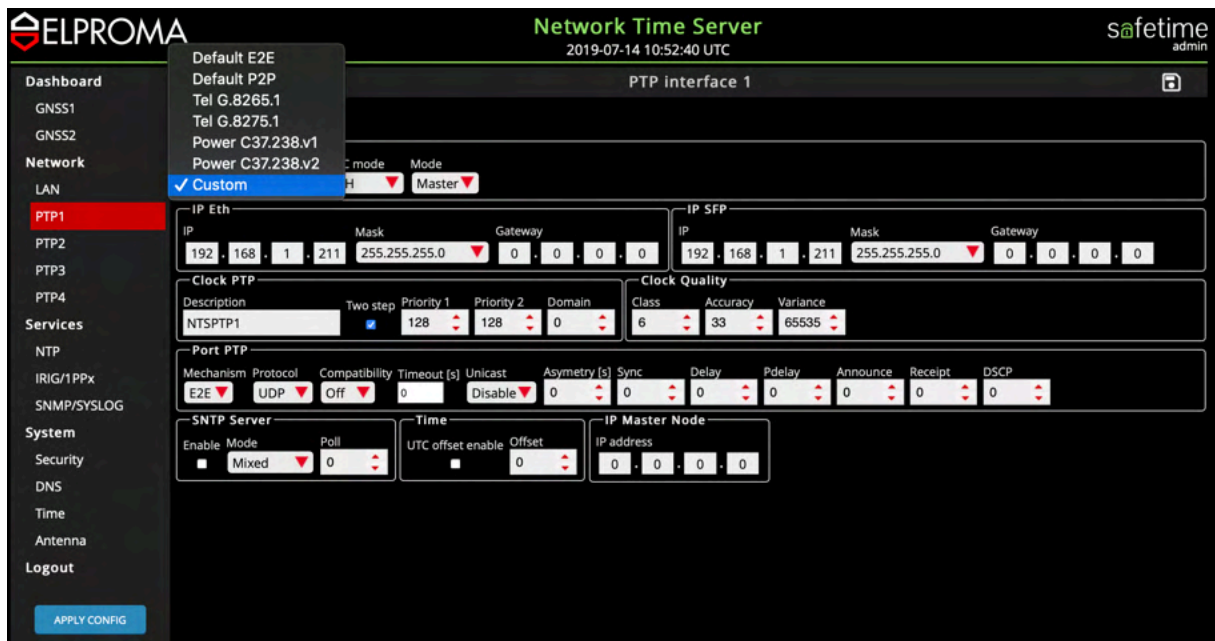

Currently supported PTP IEEE1588 profiles are:

Default E2E, Default P2P, Telecom (ITU-I G8265.1, ITU-I G8275.1, ITU-I G8275.2\*), Power (IEEE C37.238 v1, v2 – covering compliance of IEC 61850-9-3 Power Utility Profile) and Custom (you do configure manually each parameter)

Now you can set specific IPv4/IPv6 address to each PTP interface (ETH or SFP) separately:

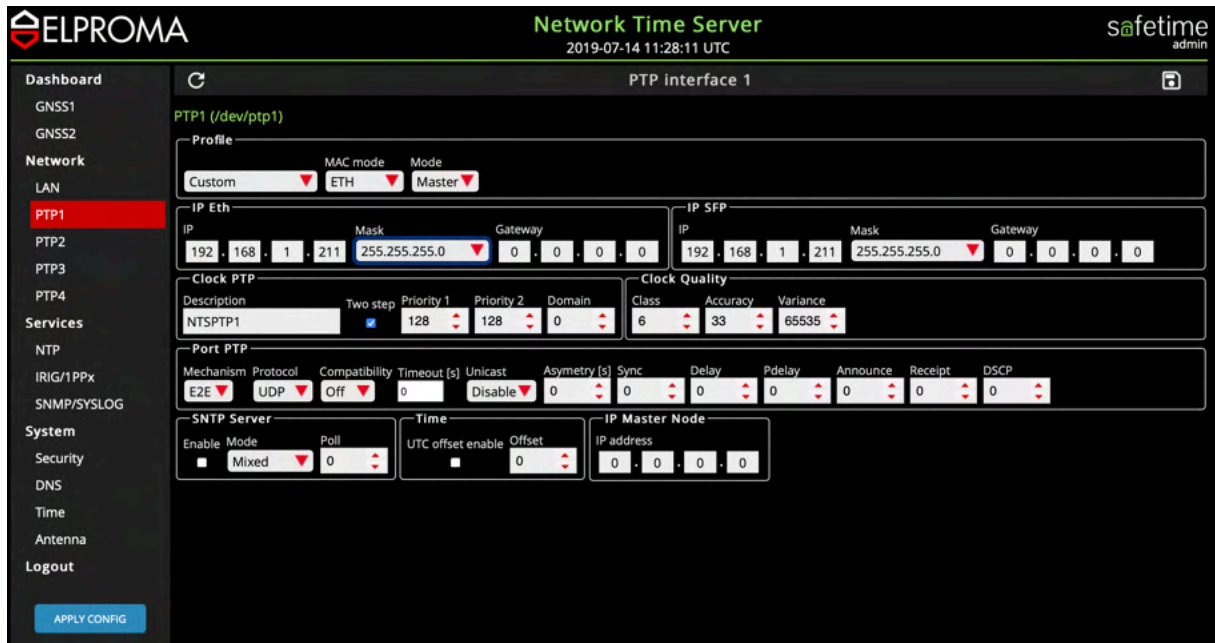

Some predefined values will help prevent against errors (e.g. subnet MASK):

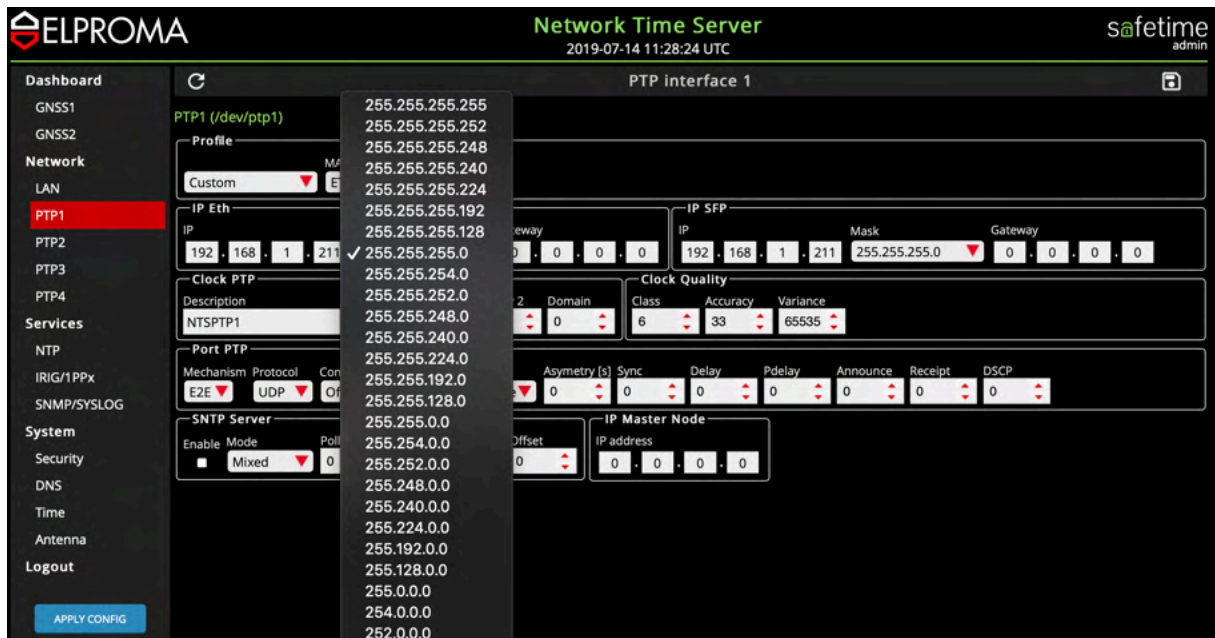

The other PTP data can be set:

The screenshot shows the configuration page for the PTP1 interface. The left sidebar contains a navigation menu with categories: Dashboard, Network (LAN, PTP1, PTP2, PTP3, PTP4), Services (NTP, IRIG/1PPx, SNMP/SYSLOG), and System (Security, DNS, Time, Antenna, Logout). The main content area is titled 'PTP interface 1' and contains the following sections:

- Profile:** Custom, MAC mode: ETH, Mode: Master.
- IP Eth:** IP: 192.168.1.211, Mask: 255.255.255.0, Gateway: 0.0.0.0.
- IP SFP:** IP: 192.168.1.211, Mask: 255.255.255.0, Gateway: 0.0.0.0.
- Clock PTP:** Description: NTSPTP1, Two step: checked, Priority 1: 128, Priority 2: 128, Domain: 0.
- Clock Quality:** Class: 6, Accuracy: 33, Variance: 65535.
- Port PTP:** Mechanism: E2E (checked), Protocol: UDP, Compatibility: Off, Timeout [s]: 0, Unicast: Disable, Asymetry [s]: 0, Sync: 0, Delay: 0, Pdelay: 0, Announce: 0, Receipt: 0, DSCP: 0.
- Time:** Enable: checked, Mode: Mixed, Poll: 0, UTC offset enable: checked, Offset: 0.
- IP Master Node:** IP address: 0.0.0.0.

An 'APPLY CONFIG' button is located at the bottom left of the configuration area.

This screenshot is identical to the one above, but with the 'Mechanism' dropdown menu open. The 'UDP' option is selected, and a tooltip is visible showing 'ETH' and 'UDP6' as options. The 'E2E' checkbox is now unchecked, and 'UDP' is checked.

**ELPROMA** Network Time Server safetime admin  
2019-07-14 11:38:46 UTC

Dashboard PTP interface 1

PTP1 (/dev/ptp1)

Profile

MAC mode: Custom | Mode: ETH | Master

IP Eth | IP SFP

IP: 192.168.1.211 | Mask: 255.255.255.0 | Gateway: 0.0.0.0 | IP: 192.168.1.211 | Mask: 255.255.255.0 | Gateway: 0.0.0.0

Clock PTP | Clock Quality

Description: NTSPTP1 | Two step:  | Priority 1: 128 | Priority 2: 128 | Domain: 0 | Class: 6 | Accuracy: 33 | Variance: 65535

Port PTP

Mechanism: E2E | Protocol: UDP | Compatibility: Off | Timeout [s]: 0 | Unicast:  Disable | Asymetry [s]: 0 | Sync: 0 | Delay: 0 | Pdelay: 0 | Announce: 0 | Receipt: 0 | DSCP: 0

SNTP Server | Time | IP Master Node

Enable:  | Mode: Mixed | Poll: 0 | UTC offset: 0 | IP address: 0.0.0.0

APPLY CONFIG

**ELPROMA** Network Time Server safetime admin  
2019-07-14 11:39:07 UTC

Dashboard PTP interface 1

PTP1 (/dev/ptp1)

Profile

MAC mode: Custom | Mode: ETH | Master

IP Eth | IP SFP

IP: 192.168.1.211 | Mask: 255.255.255.0 | Gateway: 0.0.0.0 | IP: 192.168.1.211 | Mask: 255.255.255.0 | Gateway: 0.0.0.0

Clock PTP | Clock Quality

Description: NTSPTP1 | Two step:  | Priority 1: 128 | Priority 2: 128 | Domain: 0 | Class: 6 | Accuracy: 33 | Variance: 65535

Port PTP

Mechanism: E2E | Protocol: UDP | Compatibility: Off | Timeout [s]: 0 | Unicast:  Disable | Asymetry [s]: 0 | Sync: 0 | Delay: 0 | Pdelay: 0 | Announce: 0 | Receipt: 0 | DSCP: 0

SNTP Server | Time | IP Master Node

Enable:  | Mode:  Mixed | Poll: 0 | UTC offset enable:  | Offset: 0 | IP address: 0.0.0.0

APPLY CONFIG

# 35. Software WWW – Services

## NTP backup servers

The NTS-x000 is state of the art technology server. It is designed to ensure robust synchronization, cybersecurity and easy maintenance. Therefore, each of its modules operates autonomously. This is possible due to fact, that each functional module is independent, and microprocessor controlled. You can trace and monitor status of each independent service, but you can also reset each of them.

**Network Time Server**  
2019-07-14 12:15:20 UTC

**System Status**

Service name	Status	Monitored	Monitor mode	Uptime	Restart
Antenna 1					
Antenna 2	OK	Monitored	active	5d 22h 21m	
OXIO	OK	Monitored	active	5d 22h 22m	
Rubidium	OK	Monitored	active	5d 22h 22m	
IRIG In	OK	Monitored	active	5d 22h 22m	
IRIG Out	OK	Monitored	active	5d 22h 22m	
NTP server	OK	Monitored	active	16m	
HTTP server	OK	Monitored	active	5d 22h 22m	
LED	OK	Monitored	active	5d 22h 22m	
LCD	OK	Monitored	active	5d 22h 22m	
System	OK	Monitored	active	5d 22h 22m	

You can define up to 10 of backup NTP time servers. They can be used when missing stratum 0 ref.

**Network Time Server**  
2019-07-14 13:32:22 UTC

**Services: NTP**

**NTP source servers**

Peer	Enabled	Address/IP	Key ID	Key type
1	Yes	192.168.1.2	2	SHA
2	Yes	192.168.1.3	65535	MD5
3	Yes	192.168.1.3	2	SHA
4	Yes	www.wp.pl	2	SHA

**NTP keys**

Num	ID	Type	Key
1	2	SHA	342345234235235T34TRWTRFEWFTWER4T34T4353453
2	65535	MD5	FGDRHERHEAGGEARHGGERGERHERTHRETSJHRTS
3	323	MD5	m:W(D%Zq2}nVe?
4	255	MD5	babchdyer0-ldkjweu3dksu;[]



To add new NTP-server please click (+) icon located on the top of table and provide IPv4 address:

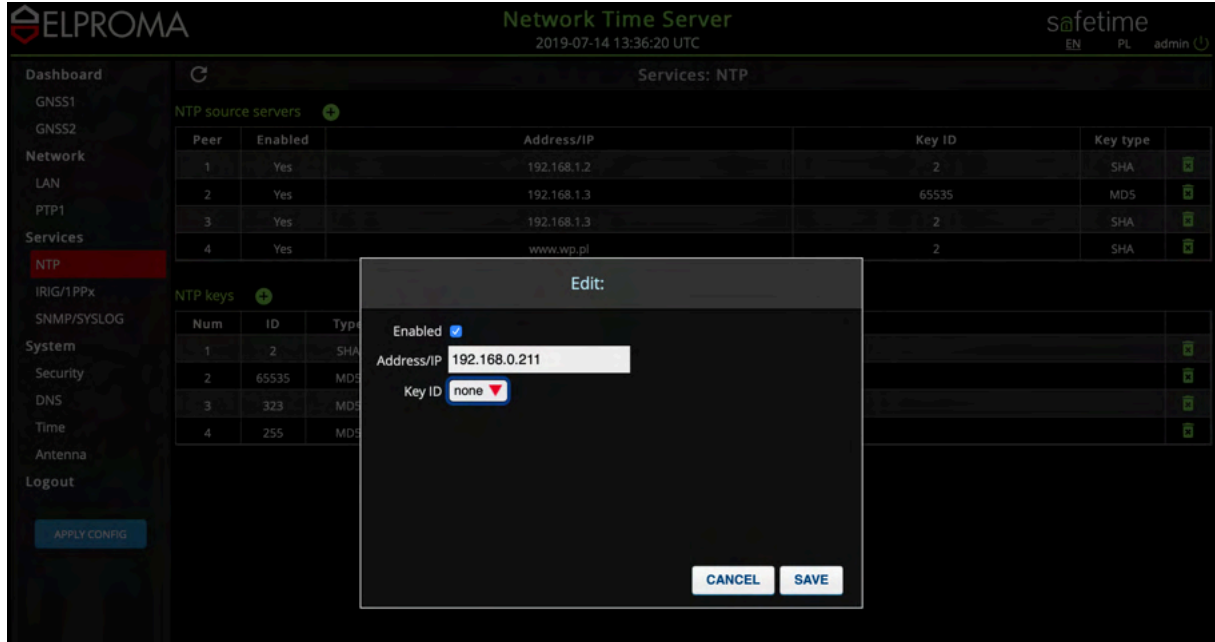

You can also add/remove authentication keys (used when NTP-authentication is necessary):

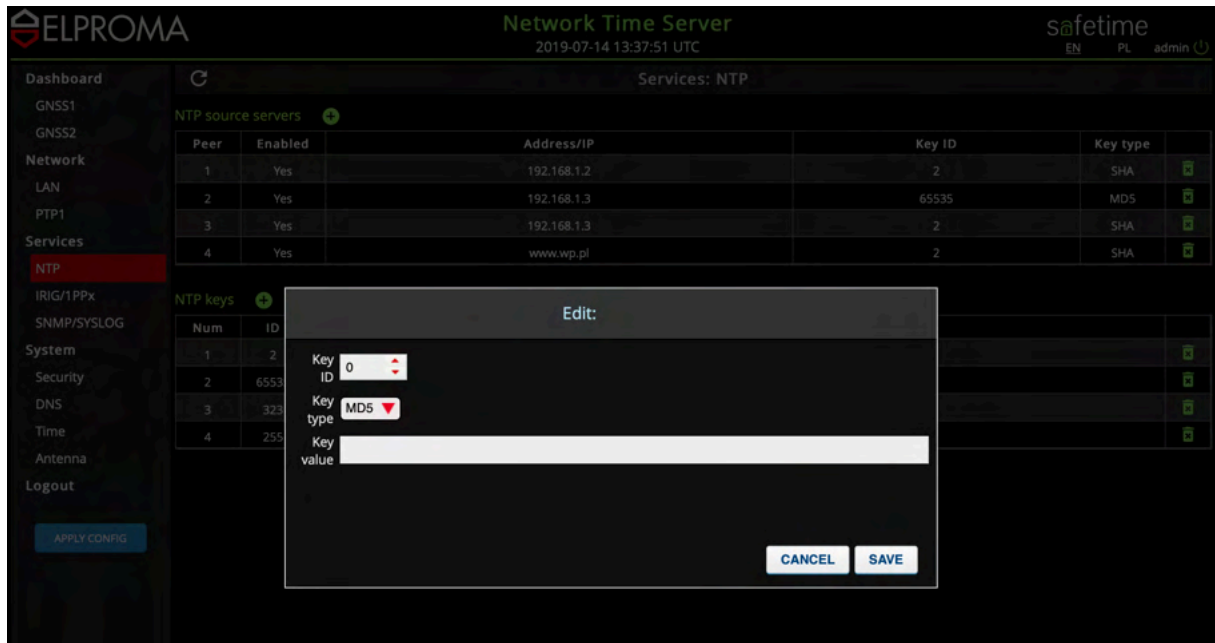

## IRIG-B/PPS-x Management

You can define direction, coding, time-code format and time-scale for IRIG-B interface:

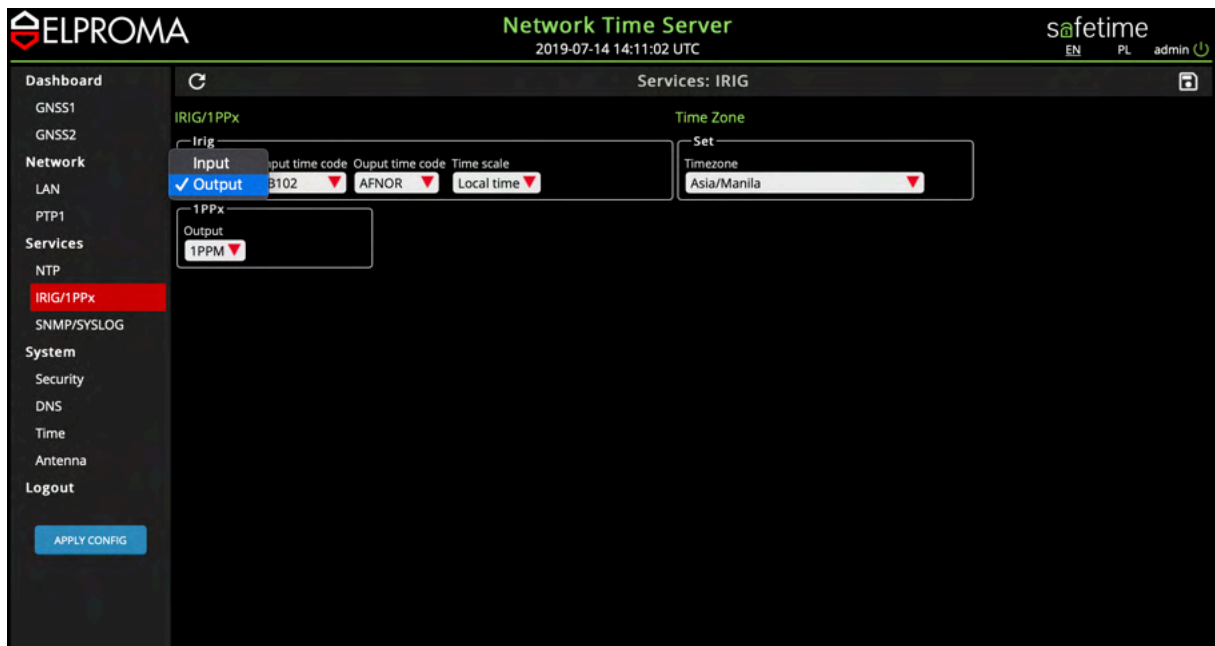
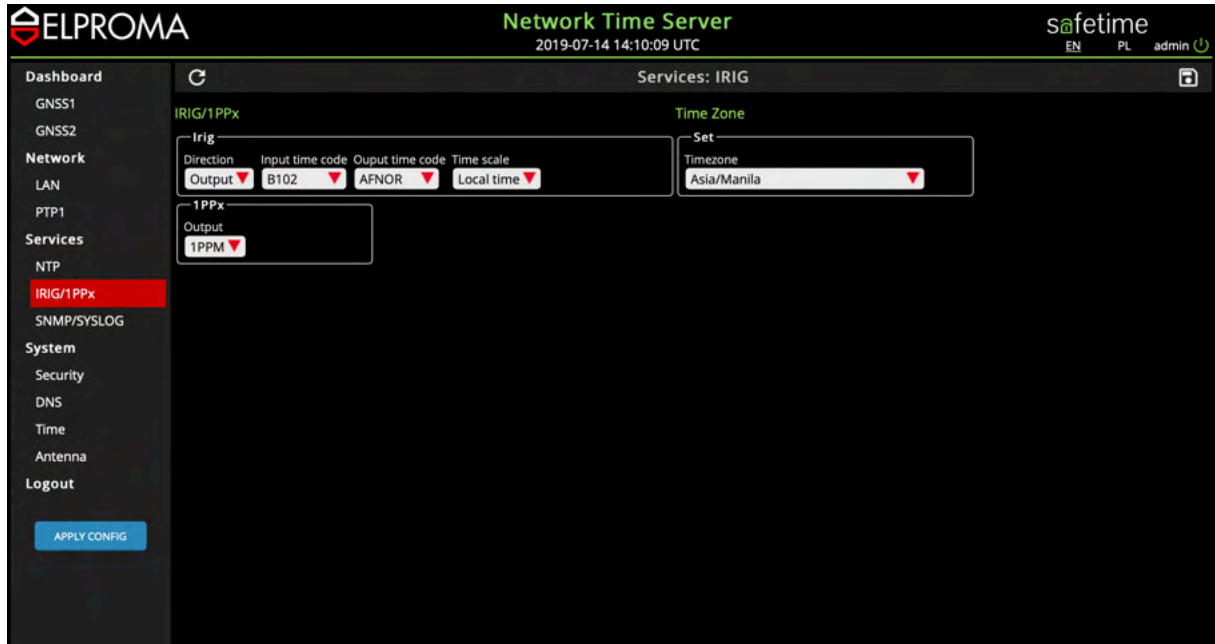

Setting IRIG-B input time-code:

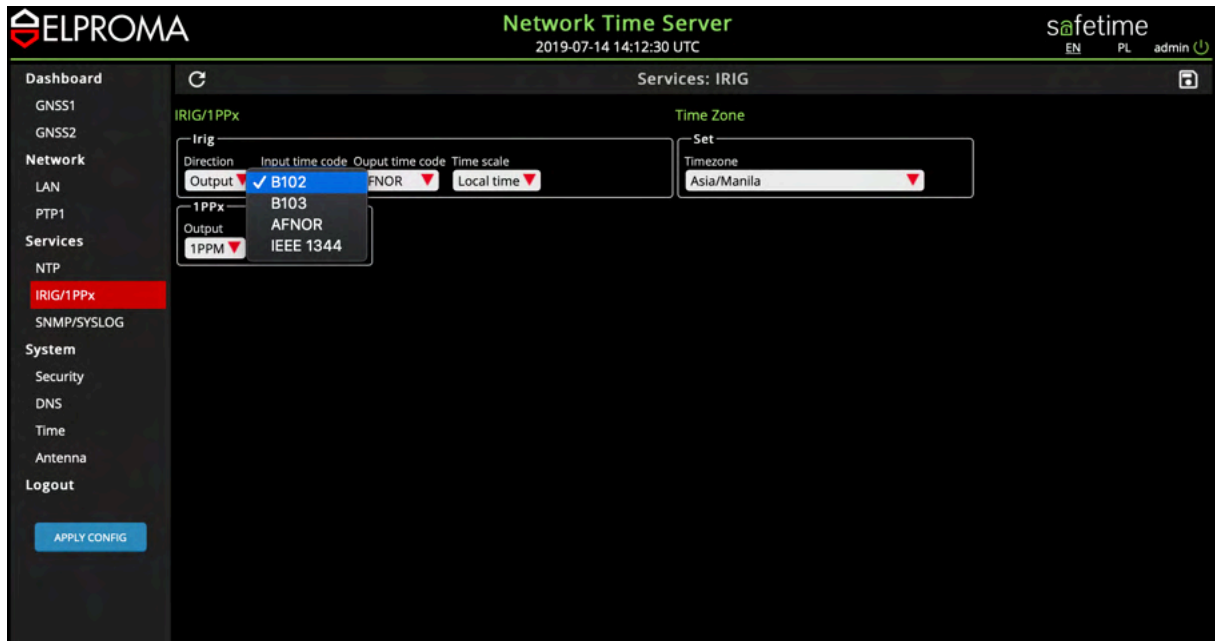

Setting IRIG-B output time-code:

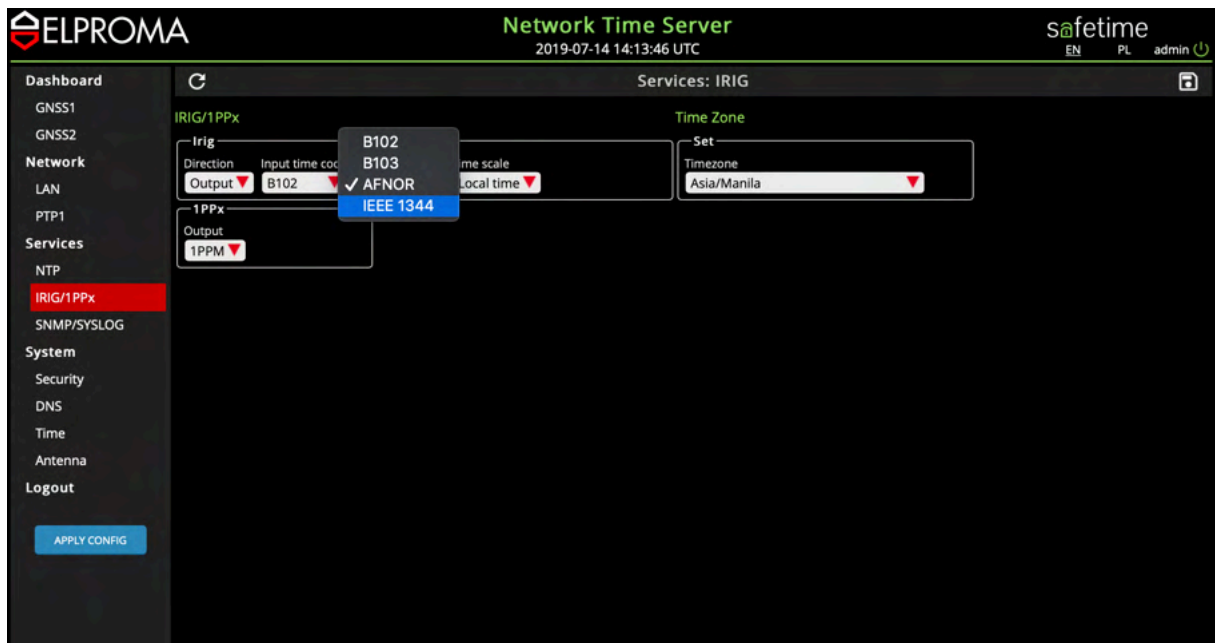

IRIG-B can be defined to operate LOCAL TIME or UTC:

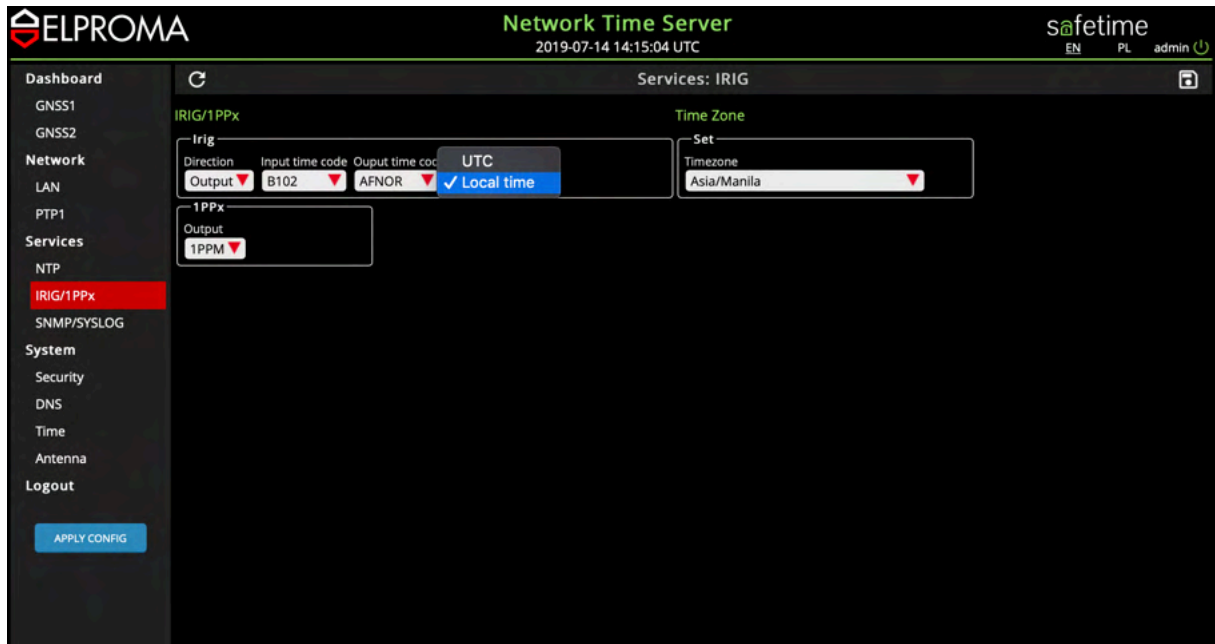

If you choose LOCAL TIME setting, you should also specify your localization for it:

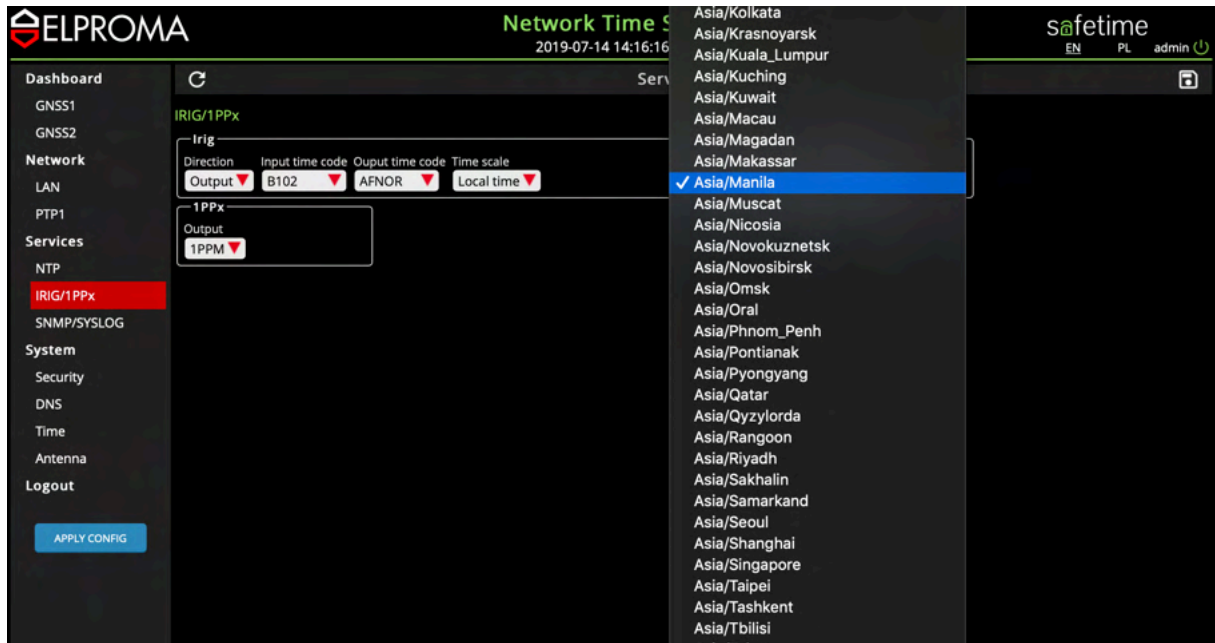

You can also decide on PPS output frequency standard:

- PPS (Pulse Per Second)
- PPM (Pulse Per Minute)
- PPH (Pulse Per Hour)

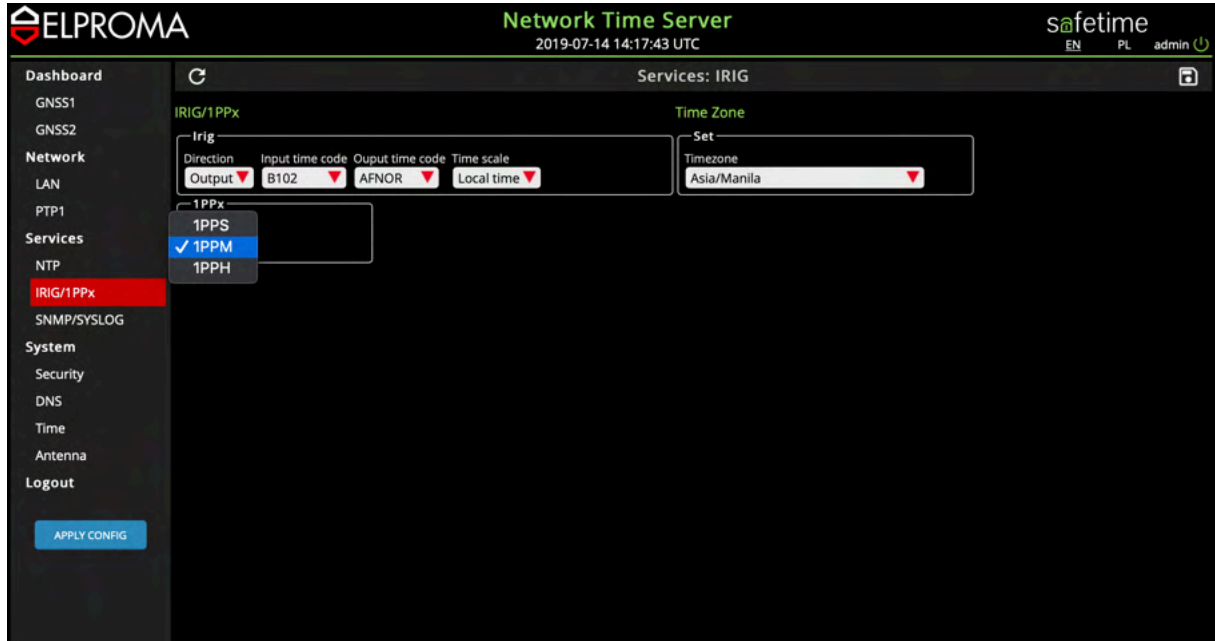

## SYSLOG/SNTP

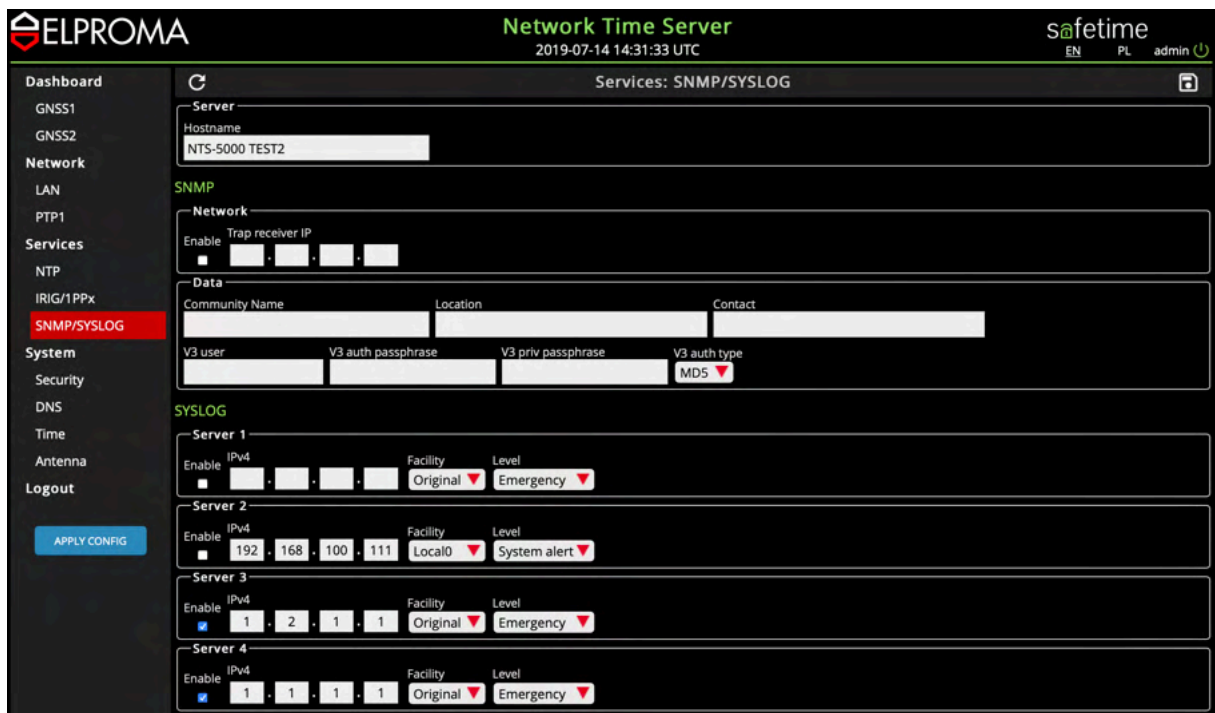

# 36. Software WWW – System Security & DNS

Following screen presents system time CLOCK frequently used by admins as information dashboard:

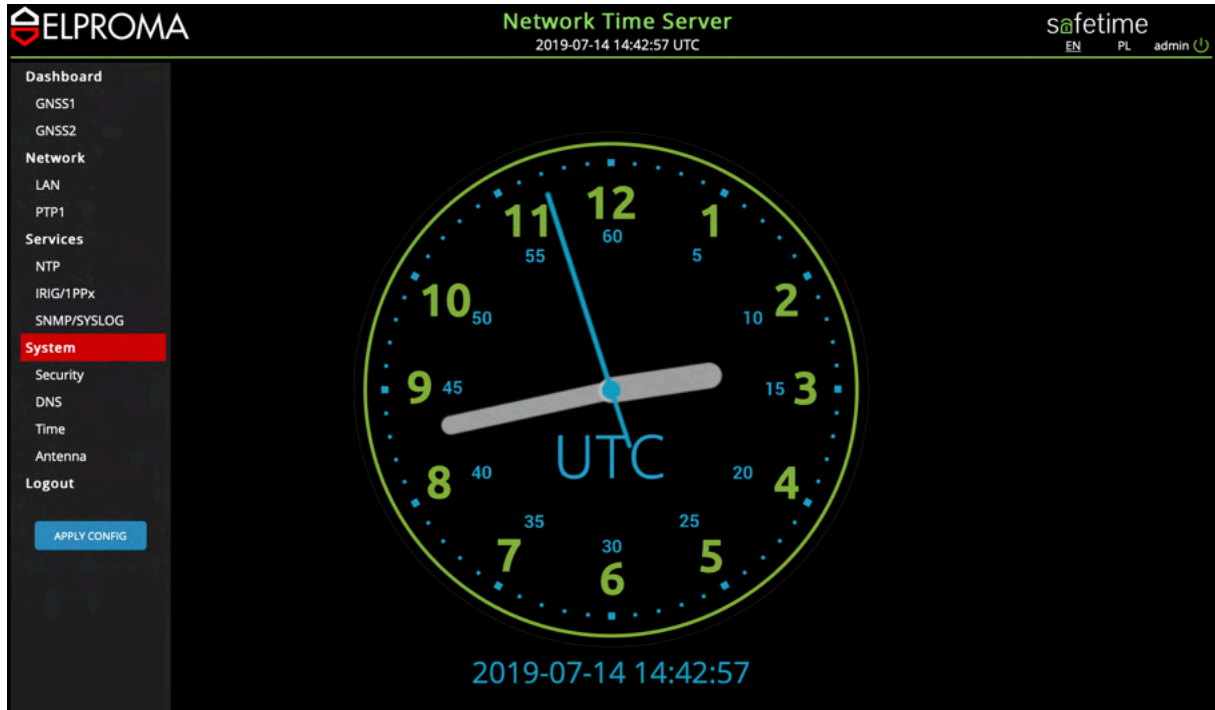

You can generate, upload or download SSL, SSH keys and manage HTTPS, Radius and configuration

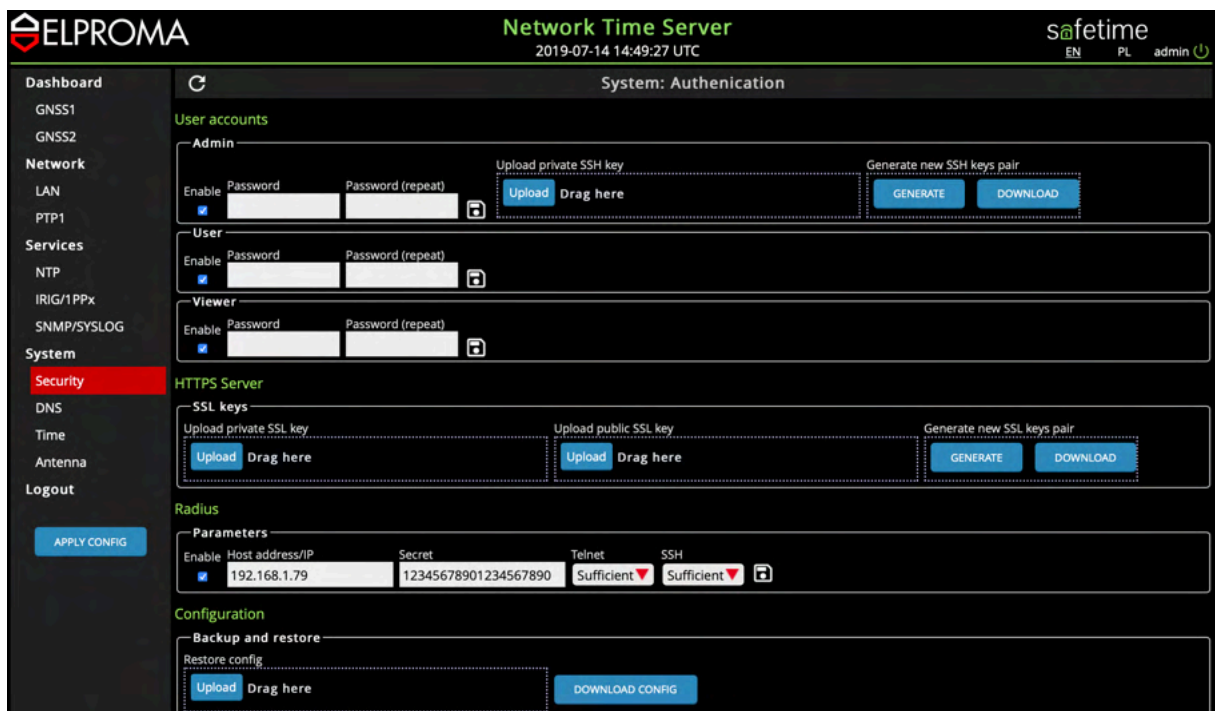

You can define up to 4x DNS servers:

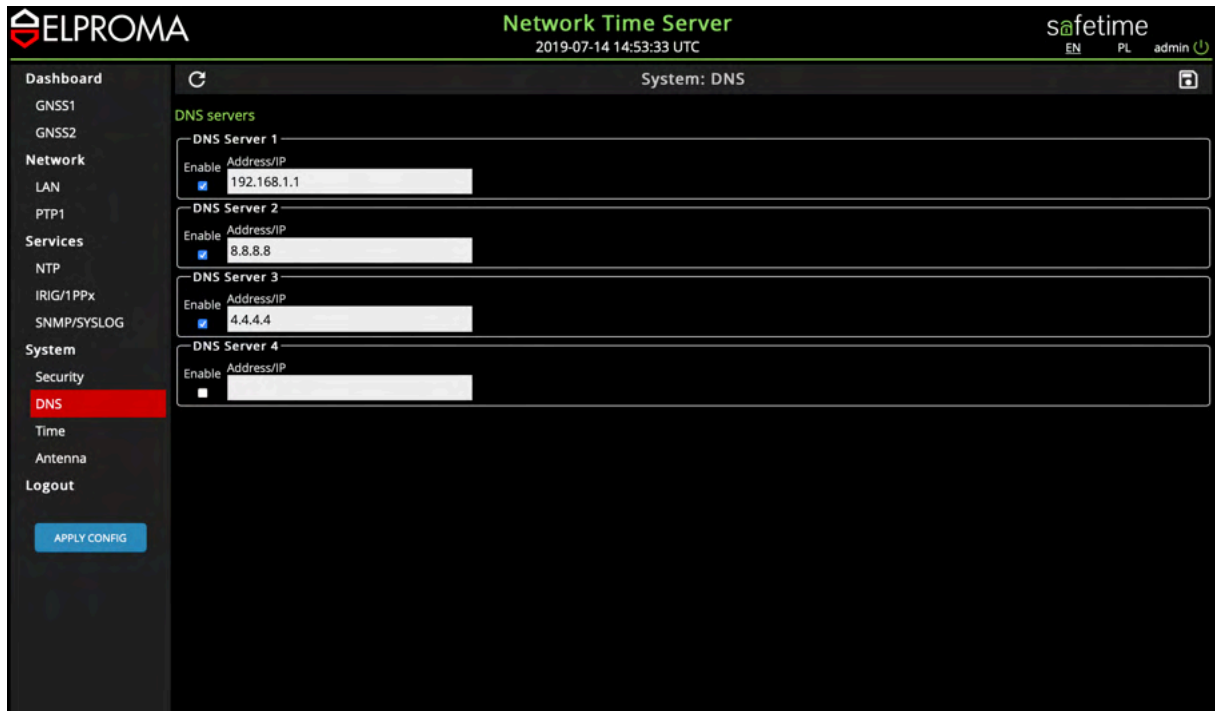

- 
-

# Setup SSH



## 37. Software SSH - Setup LAN1-LAN2

This chapter will let you configure std. LAN1 and LAN2 interfaces (100/10 Mbps) of NTS-x000 family products. All below presented operations of configuration are similar NTS-3000, NTS-4000, NTS-5000 but this chapter will describe details based on example of server NTS-5000.

The factory default (user and password) is:

Username: **admin**  
Password: **12345**

To start configuration, please configure all LAN interfaces by simply placing:

IP  
MASK  
DEFAULT GETEWAY

<pre>*LAN1 LAN2 VLAN ROUTING SYSLOG SNMP NTP DATE/TIME TIMEZONE AUTH RADIUS DNS MISC Exit</pre>	<pre>ip address:192.168.001.002  ip address: 192.168.001.002 netmask: 255.255.252.000 gateway: 192.168.001.001 ipv6 address: 0000:0000:0000:0000:0000:0000:0000:0000 prefixlength: 64 ntp broadcast: 000.000.000.000 key: -1 ntp multicast: 000.000.000.000 key: -1 telnet: yes ssh: yes http: yes https: yes snmp: yes</pre>
---	---

In addition, you can specify what mode you want to work on specific LAN interface. You can enable extra *broadcast* and *multicast* modes running in the background of standard client/server mode, but we suggest to finish basic configuration first before you go to more advanced options. Therefore, please leave those options for the moment now by simply filling fields 0.

Now it's time to decide what other remote services you like to keep active for future accessing. You access each LAN separately:

- Enable/Disable access via Telnet
- Enable/Disable access via SSH
- Enable/Disable access via HTTP
- Enable/Disable access via HTTPS
- Enable/Disable access via SNMP (MIB2)

```

LAN1
*LAN2
VLAN
ROUTING
SYSLOG
SNMP
NTP
DATE/TIME
TIMEZONE
AUTH
RADIUS
DNS
MISC
Exit

ip address:010.000.000.210

ip address: 010.000.000.210
netmask: 255.255.255.000
gateway: 000.000.000.000
ipv6 address: 0000:0000:0000:0000:0000:0000:0000:0000
prefixlength: 64
ntp broadcast: 000.000.000.000 key: -1
ntp multicast: 000.000.000.000 key: -1
telnet: no
ssh: yes
http: yes
https: yes
snmp: yes

```

Now you should repeat above steps for LAN2. It is strongly recommended to use only 1 of 2 (LAN1 or LAN2) GATEWAYS. So, if you have chosen GATEWAY for LAN1, please do not use GATEWAY for LAN2, and vice versa. It is because using 2 GATEWAYS simultaneously might cause risk of redirecting IP return packages to wrong GATEWAY output. This is well known problem for Unix and FreeBSD. To prevent such unexpected behavior we recommend setting static routing.

```

LAN1
LAN2
VLAN
*ROUTING
SYSLOG
SNMP
NTP
DATE/TIME
TIMEZONE
AUTH
RADIUS
DNS
MISC
Exit

000.000.000.000/00 via 000.000.000.000

id 1:
id 2:
id 3:
id 4:
id 5:
id 6:
id 7:
id 8:
id 9:
id 10:
id 11:
id 12:
id 13:
id 14:
id 15:
id 16:

```

A static routing is useful when considering **stub network**, or pocket network. This is a somewhat casual term describing a computer network, or part of an internetwork with no knowledge of other networks, that will typically send much or all of its non-local traffic out via a single path, with the network aware

only of a default route to non-local destinations. As a practical analogy, think of an island which is connected to the rest of the world through a bridge and no other path is available either through air or sea. Continuing this analogy, the island might have more than one physical bridge to the mainland, but the set of bridges still represents only one logical path.

NTS-x000 can use VLAN's when linked to CISCO (for information contact ELPROMA).

<pre>LAN1 LAN2 *VLAN ROUTING SYSLOG SNMP NTP DATE/TIME TIMEZONE AUTH RADIUS DNS MISC Exit</pre>	<pre>000.000.000.000/00 vlanid 0000 via LAN2  id 1: id 2: id 3: id 4: id 5: id 6: id 7: id 8: id 9: id 10: id 11: id 12: id 13: id 14: id 15: id 16:</pre>
---	--

You can also specify SYSLOG server for future tracing functionality. You can configure facility and verbosity of NTS server messages, to ease log segregation on your syslog server. Please read syslog documentation for details about logs gathering.

<pre>LAN1 LAN2 VLAN ROUTING *SYSLOG SNMP NTP DATE/TIME TIMEZONE AUTH RADIUS DNS MISC Exit</pre>	<pre>loghost address:000.000.000.000  loghost address: 000.000.000.000 facility: origin level: emerg</pre>
---	--

If your network supports SNMP, you can configure special MIB2 traps to implement exceptional facts you can be interesting in. It is very easy to set traps on such way that you will be informed by mail or mobile phone (SMS) on any unexpected situation may occur inside NTS server like e.g. losing GNSS antenna signal etc. Also you can trace all IP statistics using your favourite SNMP client (ie. *Mrtg*)

LAN1  
LAN2  
VLAN  
ROUTING  
SYSLOG  
**\*SNMP**  
NTP  
DATE/TIME  
TIMEZONE  
AUTH  
RADIUS  
DNS  
MISC  
Exit

snmp trap receiver:192.168.002.187

```

snmp trap receiver: 192.168.002.187
                hostname: ntp.elproma.com.pl
                community name: public
                location: Elproma
                contact:
                SNMPv3 user:
SNMPv3 AUTH MD5:
SNMPv3 ENC DES:

```

Another step is to define up to 10x NTP backup servers for single NTS server unit. In this mode NTS server reminds Stratum 1 if GPS antenna works fine or any other time source (PPS\_IN, Rubidium/NTS-5000only, OCXO). But in case of missing accurate time source NTS server checks backup servers list. If NTP accepts any of them the NTS server reduce its stratum to N-1 (where N is a Stratum of approved server taken out of backup list). We advise to specify only Stratum 1 servers on NTS server backup list. This does not let reduce NTS server Stratum below 2. The backup NTP servers should be configured for authorized NTP transmission. For this reason, there is another field key pointing position in encryption list with MD5 keys. But in this step we still advice to continuous Setup without encrypted associations. Safety and protection will be discussed shortly in this manual.

LAN1  
LAN2  
VLAN  
ROUTING  
SYSLOG  
SNMP  
NTP  
**\*DATE/TIME**  
TIMEZONE  
AUTH  
RADIUS  
DNS  
MISC  
Exit

```

May 24,      2017
Su Mo Tu We Th Fr Sa
01 02 03 04 05 06 07
08 09 10 11 12 13 14
15 16 17 18 19 20 21
22 23 24 25 26 27 28
29 30 31

```

Setting DATE/TIME is a tool to pre-set LOCAL clocks time. It always use to be UTC however some customers use this option to maintaining other than UTC timescales (GPS). This can be useful option to maintain local zone time too.

```

LAN1
LAN2
VLAN
ROUTING
SYSLOG
SNMP
NTP
DATE/TIME
*TIMEZONE
AUTH
RADIUS
DNS
MISC
Exit
        
```

```

Select timezone
[x]Etc
[ ]Africa
[ ]America
[ ]Antarctica
[ ]Arctic
[ ]Asia
[ ]Atlantic
[ ]Australia
[ ]Etc
[ ]Europe
[ ]Indian
        
```

Time Zone service lets set LCD time to local time. It has information meaning only and timeserver works and supports universal UTC timescale.

```

LAN1
LAN2
VLAN
ROUTING
SYSLOG
SNMP
NTP
DATE/TIME
TIMEZONE
*AUTH
RADIUS
DNS
MISC
Exit
        
```

```

PASSWD -- change access password
MD5    -- edit NTP md5 keys
VIEW   -- view NTP md5 keys
SSH    -- generate new SSH keys
SSL    -- generate new SSL keys
Return -- return to main menu
        
```

---

```

PASSWD MD5 VIEW SSH SSL Return
        
```

AUTH includes set of settings related to security and authentication including MD5 and SSH/SSL keys.

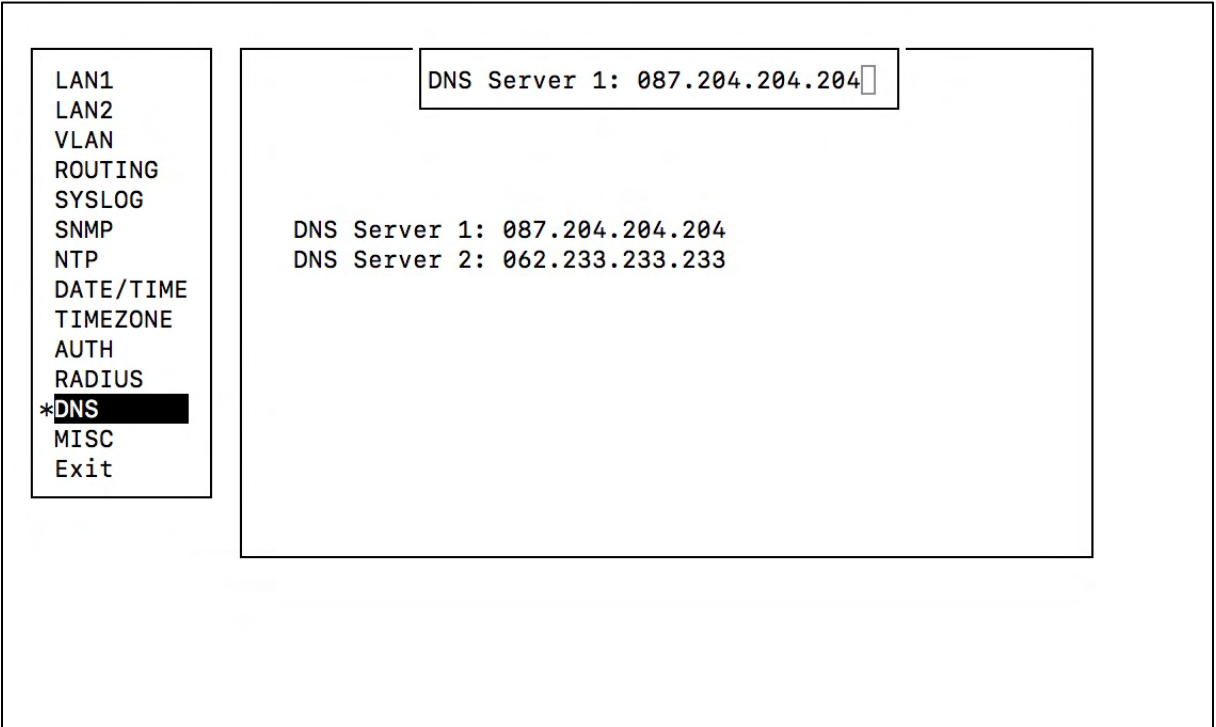
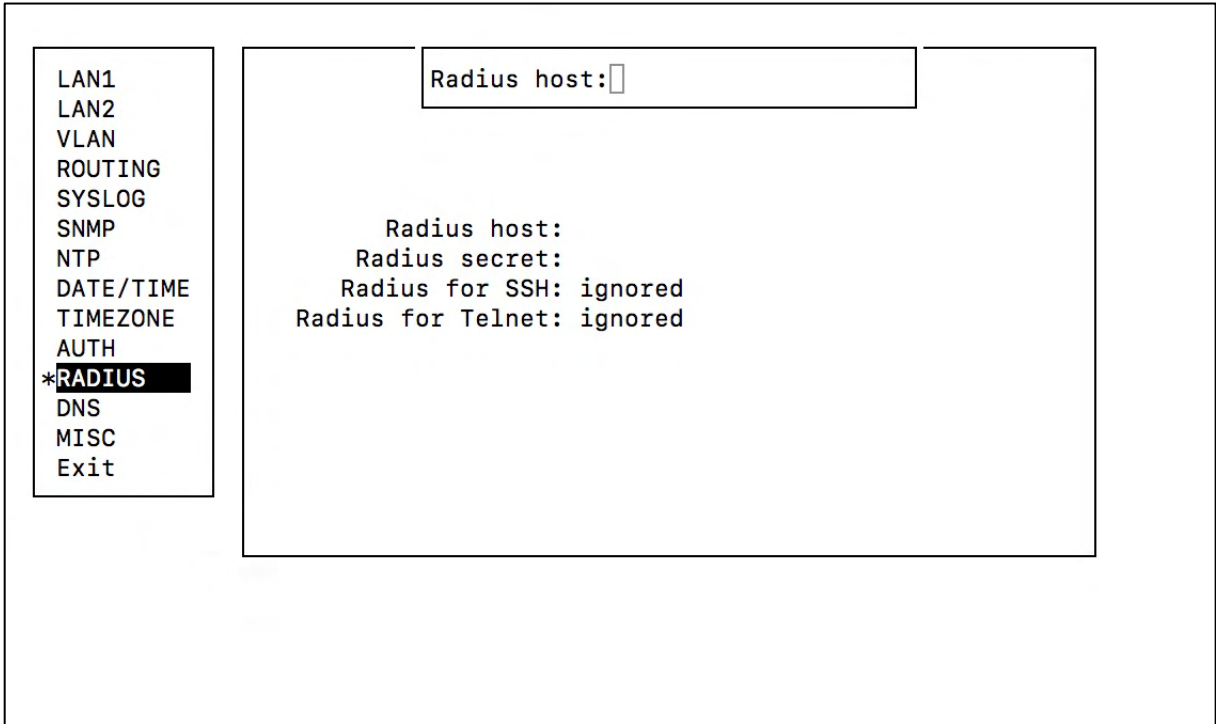

**Upgrade.** To perform firmware upgrade you should put USB memory stick with new firmware into port on front panel and then activate this option. **GPS.** With this function you can monitor GNSS receiver messages on line, just as they came. You can check receiver location and GPS status bits. **ANT A/B DIR.** This functions give you ability to send time signal in NMEA/PPS format to another NTS series unit. Just configure one antenna socket as an output (O) and connect it with 1 to 1 twisted pair cable with RJ-45 TIA-568B connectors to antenna input (I) of second NTS.

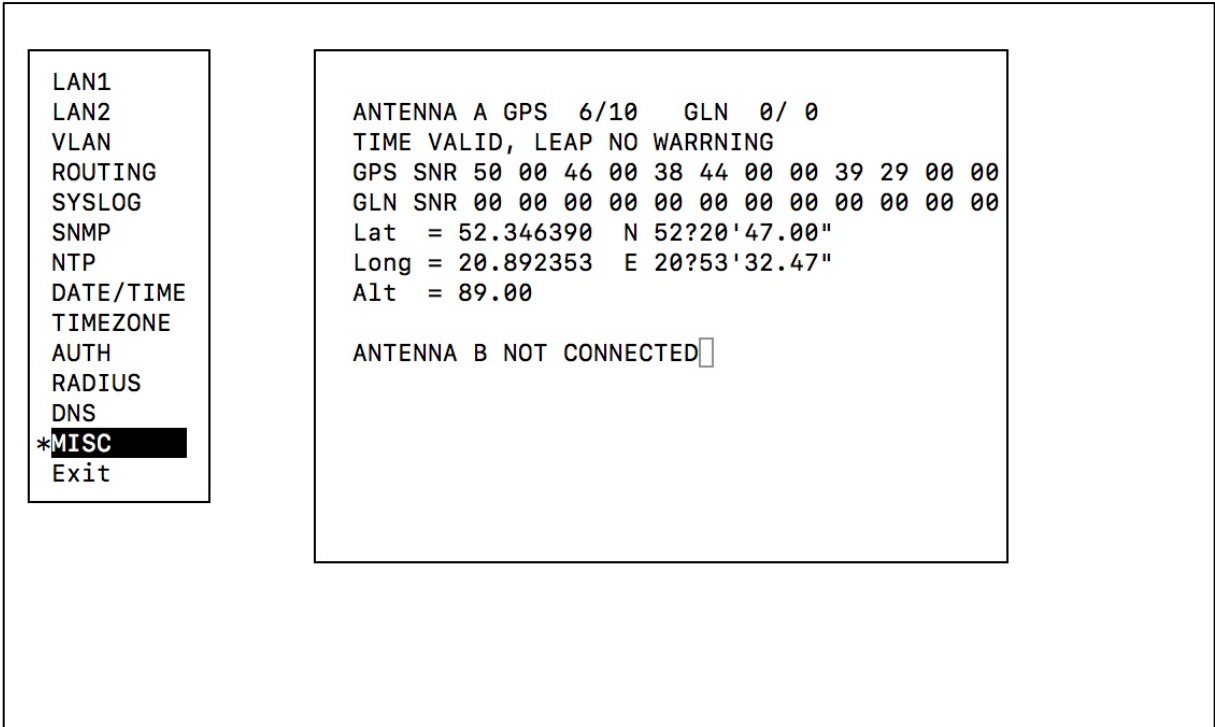
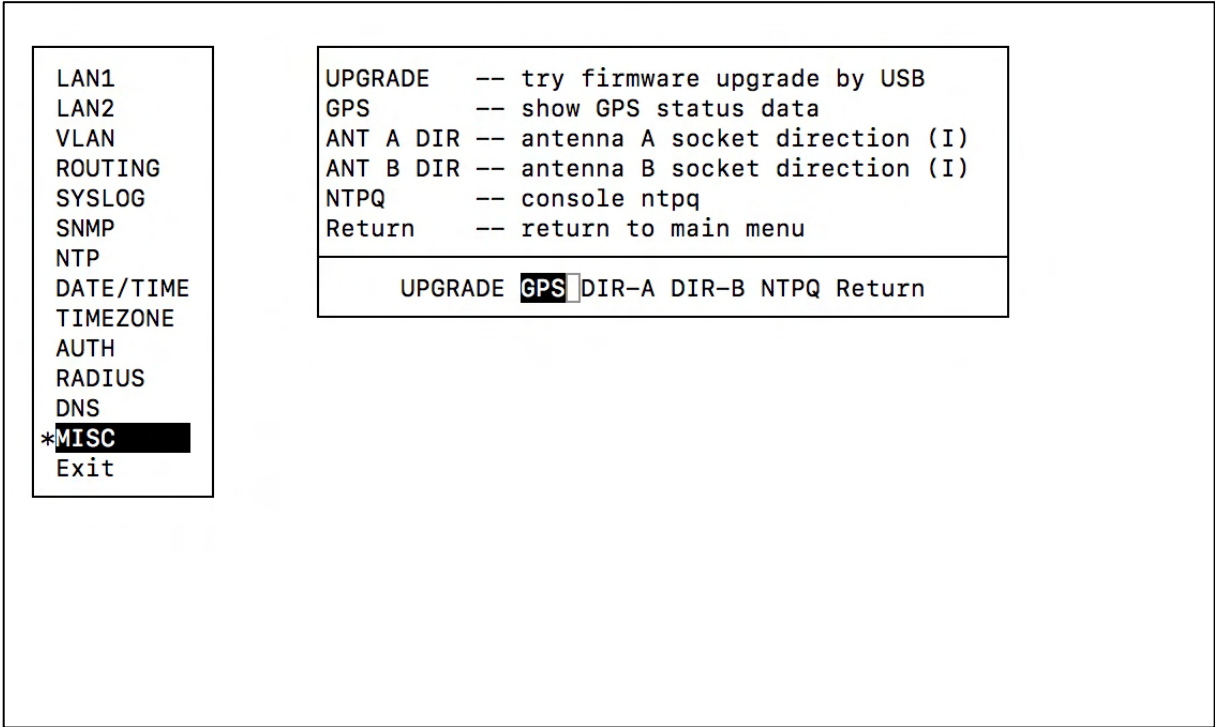

Once setup is done you have to exit with save option. Do not turn off power when NTS is saving settings (appropriate message appear on LCD). The NTS-5000 supports SETUP available via SSH and TELNET service or serial console port located on front panel (DTE configuration, 9600 baud, 8 data bits, no parity, 1 stop bit).

LAN1  
LAN2  
VLAN  
ROUTING  
SYSLOG  
SNMP  
NTP  
DATE/TIME  
TIMEZONE  
AUTH  
RADIUS  
DNS  
MISC  
\*Exit

Save settings?

Yes  No

LAN1  
LAN2  
VLAN  
ROUTING  
SYSLOG  
SNMP  
NTP  
DATE/TIME  
TIMEZONE  
AUTH  
RADIUS  
DNS  
MISC  
\*Exit

Old setting restored  
Press any key to continue



# 38. Software SSH - Setup LAN3-LAN10

This chapter includes information dedicated to NTS-5000/NTS-5000LITE PTP IEEE1588 hardware extensions. The NTS-5000/NTS-5000LITE can be equipped with 1-4 optional hardware PTP modules located at back panel of server. NTS-5000 is delivered with built-in (mounted) and calibrated PTP IEEE1588 interfaces. Therefore, all hardware PTP interfaces must be ordered and assembled at factory. If you have ordered less that required PTP interfaces, please contact Elproma technical support.

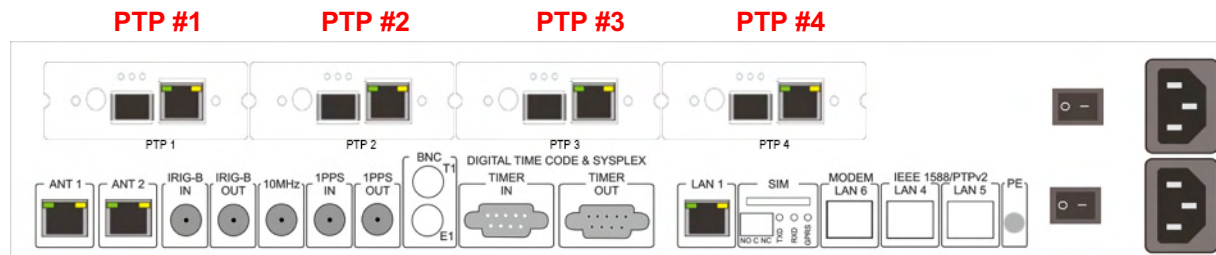

NTS-5000 Back Panel w/ high precision x4 interfaces: PTP1, PTP2, PTP3, PTP4

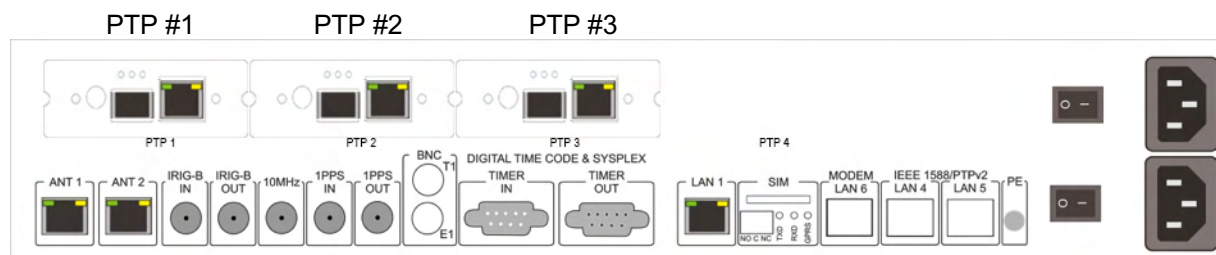

NTS-5000 Back Panel w/ high precision x3 interfaces: PTP1, PTP2, PTP3

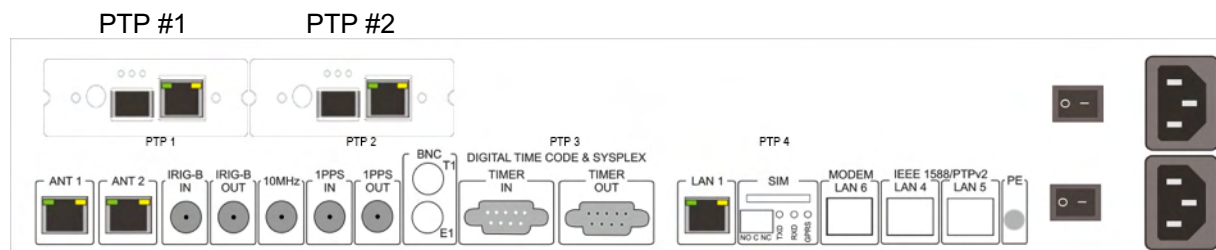

NTS-5000 Back Panel w/ high precision x2 interfaces: PTP1, PTP2

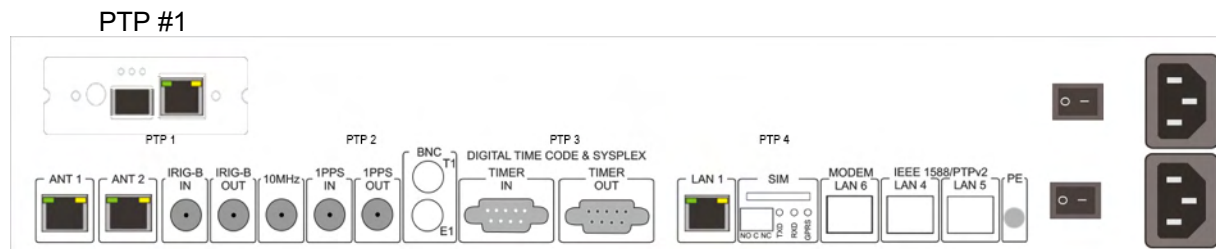

NTS-5000 Back Panel w/ high precision single PTP1 interface

Ultra-high precision nanosecond [ns] PTP/IEEE1588 extension card

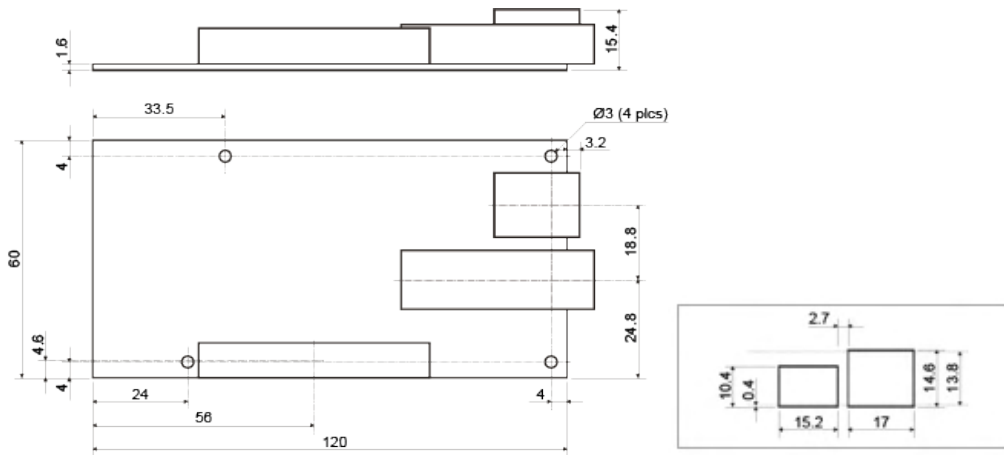

*PTP1-PTP4 hardware extension board (top view)*

*PTP1-PTP4 panel view*



*PTP1-PTP4 hardware extension cards at NTS-5000 (front view)*



*PTP1-PTP4 hardware extension cards at NTS-5000 (top view)*

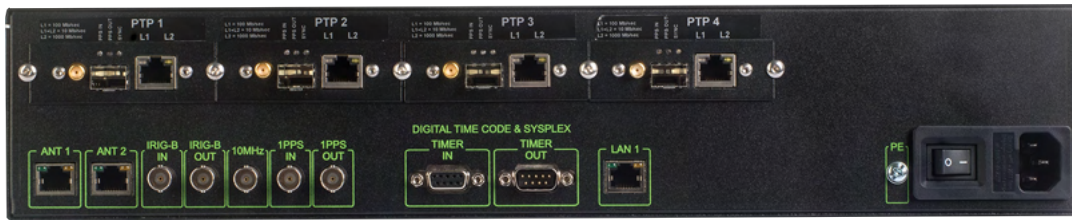

NTS-5000/NTS-5000LITE back panel view

The 1-4 hardware PTP cards must be factory pre-installed. The firmware software setup automatically recognised them and a new menu item PTP is displayed a last line before Exit item:

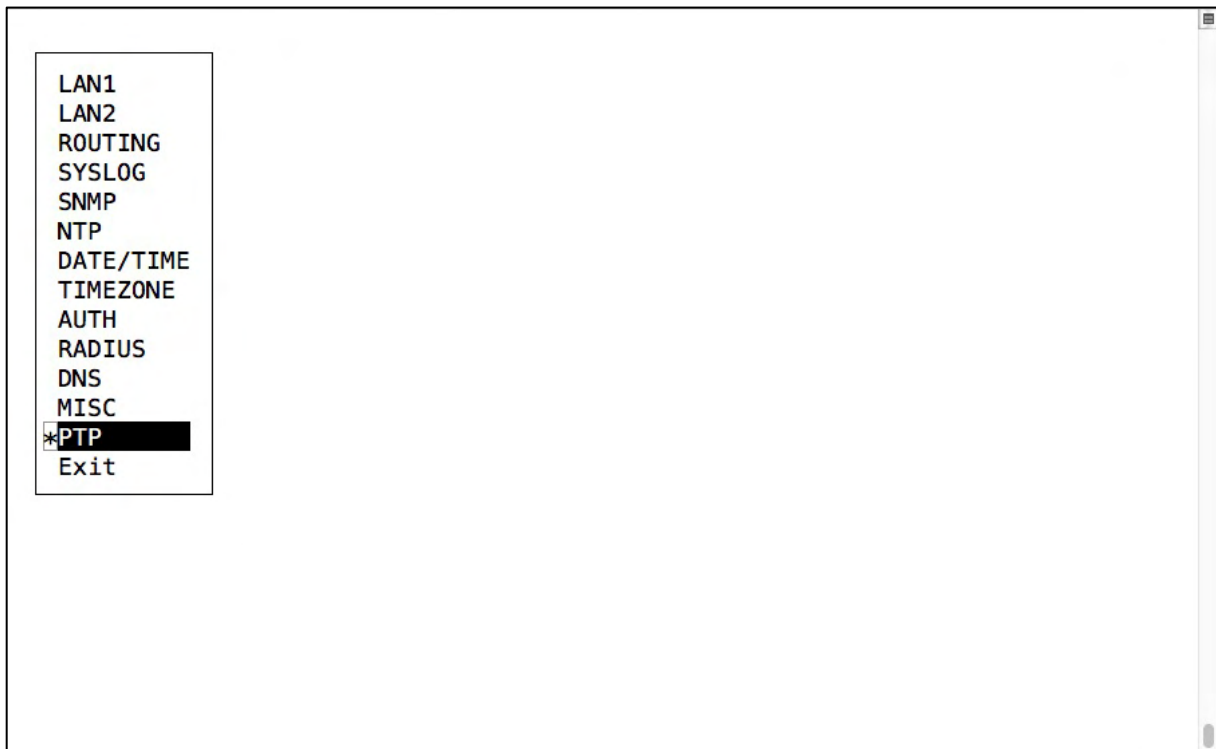

The std. UID and Password for setup are:

Username: **admin**

Password: **12345**

Depends how many Extender 1-4 cards are installed inside NTS-5000, the submenu will look like:



View of PTP Expander card configuration. This card operates autonomously:

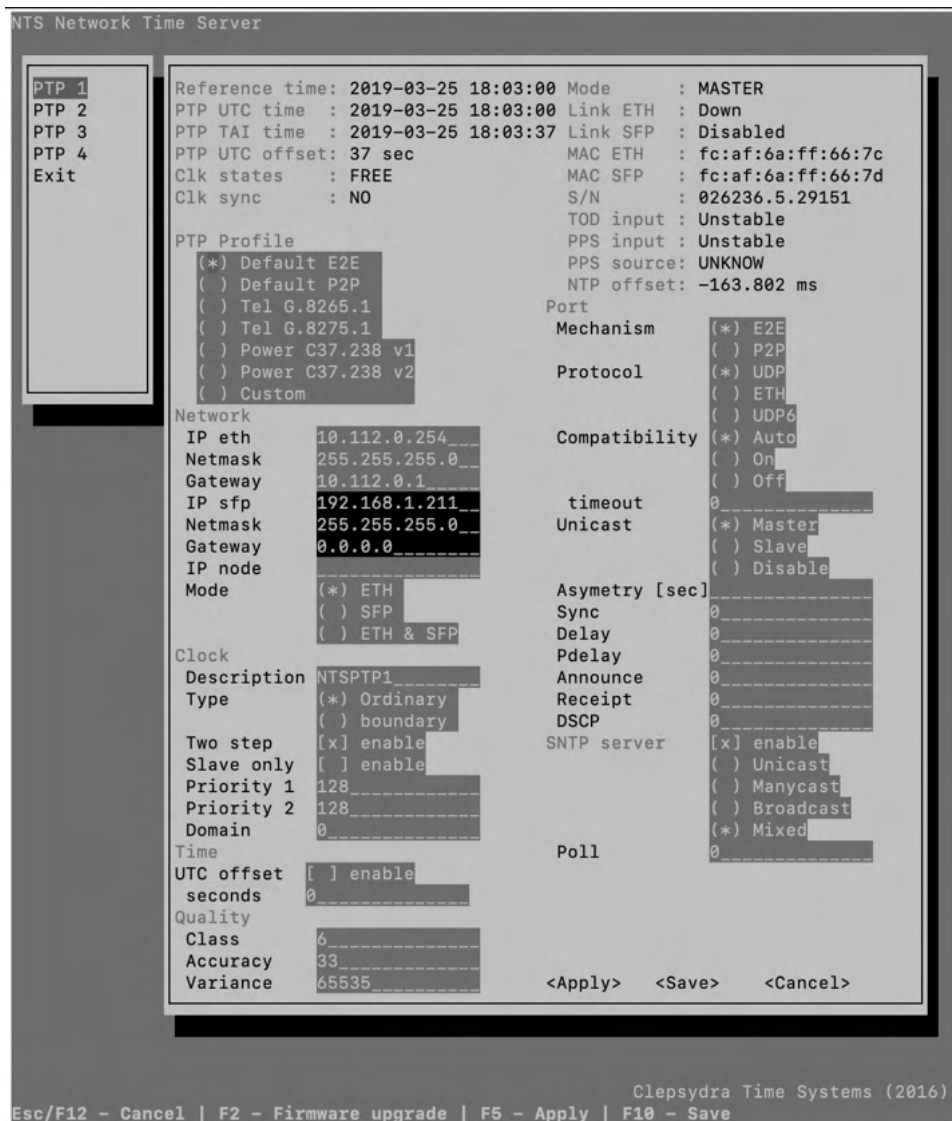

The meaning of parameters is:

### Reference time

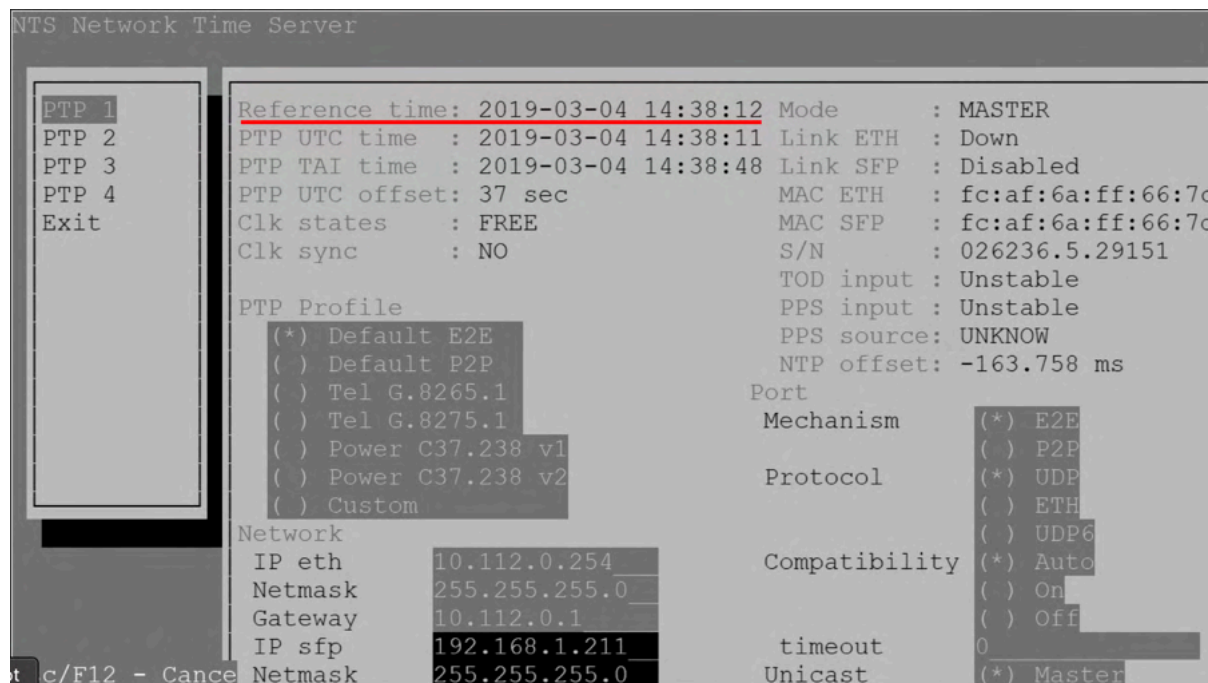

**The Reference Time** is a Grand Master Clock main time and the time domain reference of NTS-5000 time server. Usually, the reference time is a UTC, but can be also set to other scales including TAI too. Mostly the Reference Time is drawn from GNSS receiver (max. 2), but it can also be drawn from external atomic clocks. The reference time is also used to synchronize internal holdover oscillators (Rubidium and OCXO). Reference time is redistributed internally to all server outputs including network interfaces (PTP/NTP protocols), hardware IRIG-B output, SYSPLEX output, PPS-out, 10MHz-out etc.

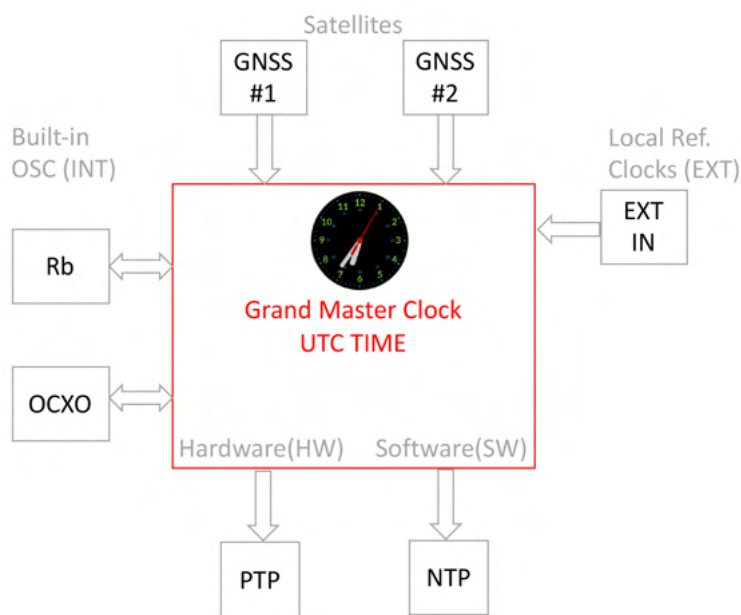

*The Reference Time is a main input time used to ensure time domain operation of NTS-5000.*

## PTP UTC Time

```

NTS Network Time Server
PTP 1
PTP 2
PTP 3
PTP 4
Exit
Reference time: 2019-03-04 14:38:12 Mode : MASTER
PTP UTC time : 2019-03-04 14:38:11 Link ETH : Down
PTP TAI time : 2019-03-04 14:38:48 Link SFP : Disabled
PTP UTC offset: 37 sec MAC ETH : fc:af:6a:ff:66:7d
Clk states : FREE MAC SFP : fc:af:6a:ff:66:7d
Clk sync : NO S/N : 026236.5.29151
TOD input : Unstable
PPS input : Unstable
PPS source: UNKNOW
NTP offset: -163.758 ms
PTP Profile
(*) Default E2E
() Default P2P
() Tel G.8265.1
() Tel G.8275.1
() Power C37.238 v1
() Power C37.238 v2
() Custom
Port
Mechanism (*) E2E
() P2P
Protocol (*) UDP
() ETH
() UDP6
Compatibility (*) Auto
() On
() Off
timeout 0
Unicast (*) Master
Network
IP eth 10.112.0.254
Netmask 255.255.255.0
Gateway 10.112.0.1
IP sfp 192.168.1.211
Netmask 255.255.255.0

```

This is **PTP UTC time** is general information purpose time information. It is basis on software measurement done at input of Expander PTP BUS internal input. It is the same time as Reference Time sent, but on another side of the bus – at arrive to PTP module hardware. A little observed offset to Reference Time is related to software way of measurement and has now impact on final accuracy of synchronization. This parameter has diagnostic purpose and it used to ensure there is pending internal synchronization.

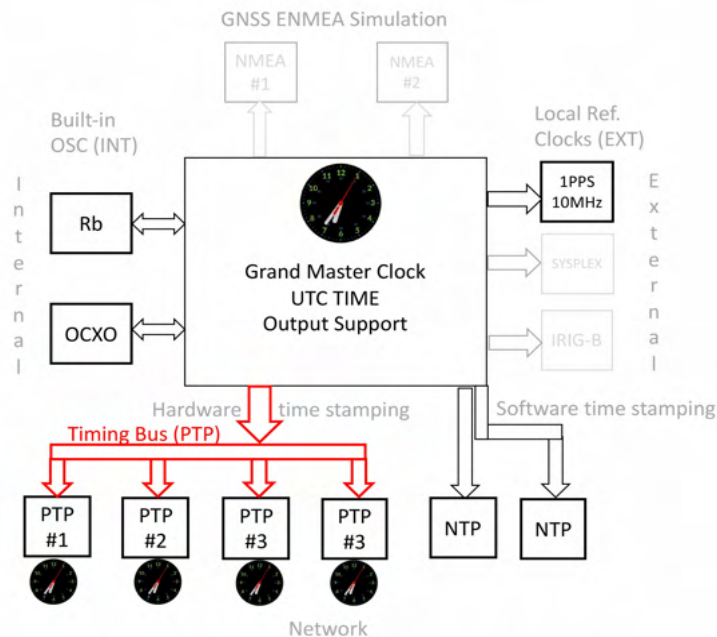

## PTP TAI time

```
NTS Network Time Server

PTP 1
PTP 2
PTP 3
PTP 4
Exit

Reference time: 2019-03-04 14:38:12 Mode : MASTER
PTP UTC time : 2019-03-04 14:38:11 Link ETH : Down
PTP TAI time : 2019-03-04 14:38:48 Link SFP : Disabled
PTP UTC offset: 37 sec MAC ETH : fc:af:6a:ff:66:7d
Clk states : FREE MAC SFP : fc:af:6a:ff:66:7d
Clk sync : NO S/N : 026236.5.29151
TOD input : Unstable
PPS input : Unstable
PPS source: UNKNOW
NTP offset: -163.758 ms

PTP Profile
(*) Default E2E
() Default P2P
() Tel G.8265.1
() Tel G.8275.1
() Power C37.238 v1
() Power C37.238 v2
() Custom

Port
Mechanism (*) E2E
() P2P
Protocol (*) UDP
() ETH
() UDP6
Compatibility (*) Auto
() On
() Off
timeout 0
Unicast (*) Master

Network
IP eth 10.112.0.254
Netmask 255.255.255.0
Gateway 10.112.0.1
IP sfp 192.168.1.211
Netmask 255.255.255.0

hot /F12 - Cance
```

Is the same as **PTP UTC time** but recalculated to TAI – the Atomic Time Scale. Currently the TAI is 37 leap seconds ahead to UTC. The number of **#leap\_seconds** is indicated next line.

```
NTS Network Time Server

PTP 1
PTP 2
PTP 3
PTP 4
Exit

Reference time: 2019-03-04 14:38:12 Mode : MASTER
PTP UTC time : 2019-03-04 14:38:11 Link ETH : Down
PTP TAI time : 2019-03-04 14:38:48 Link SFP : Disabled
PTP UTC offset: 37 sec MAC ETH : fc:af:6a:ff:66:7d
Clk states : FREE MAC SFP : fc:af:6a:ff:66:7d
Clk sync : NO S/N : 026236.5.29151
TOD input : Unstable
PPS input : Unstable
PPS source: UNKNOW
NTP offset: -163.758 ms

PTP Profile
(*) Default E2E
() Default P2P
() Tel G.8265.1
() Tel G.8275.1
() Power C37.238 v1
() Power C37.238 v2
() Custom

Port
Mechanism (*) E2E
() P2P
Protocol (*) UDP
() ETH
() UDP6
Compatibility (*) Auto
() On
() Off
timeout 0
Unicast (*) Master

Network
IP eth 10.112.0.254
Netmask 255.255.255.0
Gateway 10.112.0.1
IP sfp 192.168.1.211
Netmask 255.255.255.0

hot /F12 - Cance
```

**TOD input, PPS input, PPS source**

Directly after NTS-5000 power ON the information looks following:

```

NTS Network Time Server
PTP 1
PTP 2
PTP 3
PTP 4
Exit
Reference time: 2019-03-04 14:38:12 Mode      : MASTER
PTP UTC time  : 2019-03-04 14:38:11 Link ETH  : Down
PTP TAI time  : 2019-03-04 14:38:48 Link SFP  : Disabled
PTP UTC offset: 37 sec          MAC ETH   : fc:af:6a:ff:66:7d
Clk states    : FREE           MAC SFP   : fc:af:6a:ff:66:7d
Clk sync      : NO            S/N      : 026236.5.29151
                                TOD input  : Unstable
                                PPS input  : Unstable
                                PPS source : UNKNOW
PTP Profile
(*) Default E2E
() Default P2P
() Tel G.8265.1
() Tel G.8275.1
() Power C37.238 v1
() Power C37.238 v2
() Custom
NTP offset: -163.758 ms
Port
Mechanism      (*) E2E
                () P2P
Protocol       (*) UDP
                () ETH
                () UDP6
Compatibility  (*) Auto
                () On
                () Off
timeout        0
Unicast        (*) Master
Network
IP eth         10.112.0.254
Netmask        255.255.255.0
Gateway        10.112.0.1
IP sfp         192.168.1.211
Netmask        255.255.255.0
  
```

Once NTS-5000 server gets synchronized to *Reference time*, it starts to produce internal synchronization signals on Time Transfer Bus (TTB). These signals are input to Expander card. When Extender is internally synchronized to *Reference time* it shows information as presented below:

```

NTS Network Time Server
PTP 1
PTP 2
PTP 3
PTP 4
Exit
Reference time: 2016-08-02 20:07:50 Mode      : Master loop
PTP UTC time  : 2016-08-02 20:07:50 MAC      : fc:af:6a:ff:0e:9d
PTP time      : 2016-08-02 20:08:26 Link     : 100Mb/Full
PTP UTC offset: 36 sec          TOD input  : Stable
Clk states    : Syncing        PPS input  : Stable
Clk sync      : Yes           PPS source : Rubidium
                                PPS in/out: 17 usec
Network
IP address    10.0.1.70
Netmask       255.255.255.0
Gateway       10.0.1.1
Mac mode      (*) ETH
              ( ) SFP
Clock
Description   NTSPTP1
Type          (*) Ordinary
              ( ) Boundary
Two step      [x] enable
Slave only    [ ] enable
Priority 1    128
Priority 2    128
Port
Mechanism     (*) E2E
              ( ) P2P
Protocol      (*) UDP
              ( ) ETH
              ( ) UDP6
Compatibility  ( ) Auto
              ( ) On
              (*) Off
timeout       0
Unicast       ( ) Master
              ( ) Slave
              (*) Disable
Asymetry
  
```

**Notes on TTB (Time Transfer Bus) and signals as: TOD input, PPS input, PPS source**



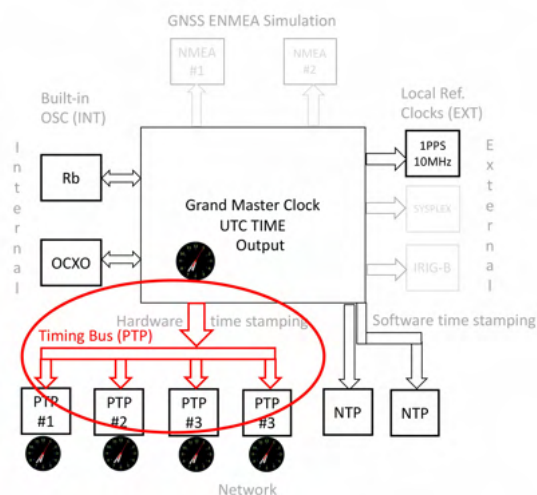

Internal Timing Bus redistributes UTC time from GMC to all 1-4 PTP autonomous op. modules

The **Time Transfer Bus (TTB)** supports following synchronization signals and dataflow:

- **1PPS (Pulse Per Second)** high accuracy frequency reference. Built-in 1:4 signal splitter share this single GMC reference to all 1-4 PTP modules.
- **ToD (Time of Day)** UTC phase data information. It tightly corresponds to 1PPS above data. It is sent via serial communication to all 1-4 PTP modules.
- **Extended info** package of data includes additional information from GMC incl. LEAP\_SECOND and ERROR BUDGET.

Unless additional factors are taken in the account, in broad outline it can be assumed rightness that **Reference Time** is equal **PTP UTC Time**. Considered factors are:

- Latency if I/O at GMC module output and PTP module input
- Latency of time transfer at TB (Internal Time Transfer Bus between GMC and PTP module)
- Time scale computing algorithms TAI-UTC
- Others minor factors

The NTS-5000 unit arrives factory pre-calibrated. However, because of aging of electronic elements some differences can be observed in the future. This might require recalibration. Furthermore, NTS-5000 provides self-audit monitoring. It gives additional information about stability of internal synchronization signals (PPS, ToD) at the time they arrive from TTB to PTP Extender card.

Those parameters are:

**ToD input:** <value>  
**PPS input:** <value>

Where value are:

- **Stable** - when TTB signals are examined by PTP module to be stable
- **Unstable** - when TTB signals are examined by PTP module to be unstable  
The PTP modules switches then to local holdover (HO) mode TCXO driven
- **Unknown** - when PTP cannot examine the quality of TTB input signals to be stable/unstable

There are several possible scenarios of action when other than **Stable** status is reach. This manual is not providing details on such algorithms. Nevertheless, the **USER** should assume NTS-5000 unit is trying to resolve the problem automatically at grandmaster level (GMC – Grand Master Clock time management level).

The **PPS source** values can be:

- **Rubidium** (GMC level)
- **OCXO** (GMC level)
- **PPSa** (GNSS #1)
- **PPSb** (GNSS #2)
- **EXT** (1PPS-in EXT)
- **SYS** (SYSPLEX)
- **IRIG** (IRIG-B IN)

Note! After both internal oscillators (Rubidium and OCXO) are synchronized to GNSS, the NTS-5000 users mostly observe status of PPS source:

- **PPS source: Rubidium**
- **PPS source: OCXO**

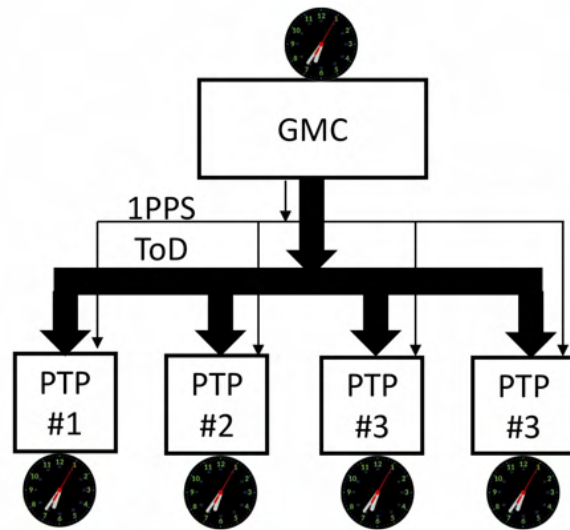

Time Synchronization Bus GMC-PTP(1-4)

Before Rubidium/OCXO are synchronized, other values like PPSa (GNSS#1) or PPSb (GNSS#2) can be observed in PPS source too.

```

NTS Network Time Server
PTP 1
PTP 2
PTP 3
PTP 4
Exit
Reference time: 2016-08-02 20:07:50 Mode      : Master loop
PTP UTC time  : 2016-08-02 20:07:50 MAC       : fc:af:6a:ff:0e:9d
PTP time     : 2016-08-02 20:08:26 Link      : 100Mb/Full
PTP UTC offset: 36 sec
Clk states   : Syncing
Clk sync    : Yes
TOD input   : Stable
PPS input   : Stable
PPS source  : Rubidium
PPS in/out  : 17 usec

Network
IP address  10.0.1.70
Netmask    255.255.255.0
Gateway    10.0.1.1
Mac mode   (*) ETH
           () SFP

Port
Mechanism  (*) E2E
           () P2P
Protocol   (*) UDP
           () ETH
           () UDP6
Compatibility
           () Auto
           () On
           (*) Off
timeout    0
Unicast    () Master
           () Slave
           (*) Disable

Clock
Description NTSPTP1
Type        (*) Ordinary
           () Boundary
Two step    [x] enable
Slave only  [ ] enable
Priority 1  128
Priority 2  128

Asymetry
  
```

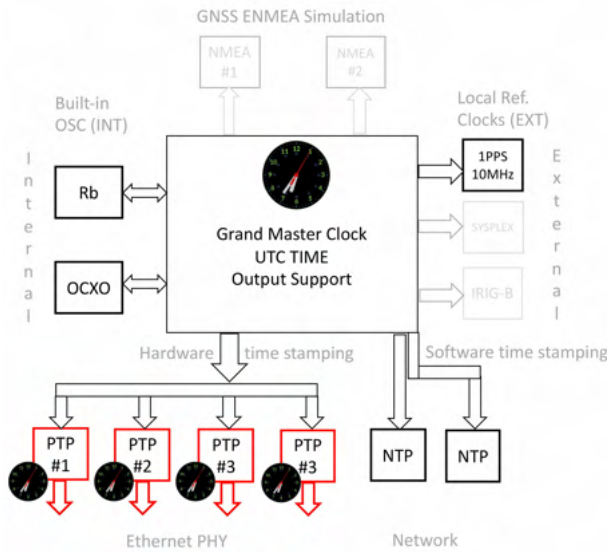

1-4 PTPv2/IEEE1588:2008 autonomous operating modules- each with own local TCXO oscillator and clock (Master Clock – MCLK)

**PTPv2/IEEE1588:2008 output generation:**

Each of 1-4 PTP modules is prepared for autonomous operation IEEE1588:2008 standard generation to Eth (SFP or RJ45).

Before modules are operationally ready they local clocks needs to be synchronized first. Each module includes at least TCXO oscillator for sub-local holdover operation (independently on Rubidium/OCXO at GMC level). Each Expander module includes autonomous operating functionality to act a Master Clock.

The synchronization process of 1-4 PTP modules can be traced via variables:

**Clk states: Syncing**  
**Clk sync : Yes**

Assuming the **PPS/ToD input** signals (sent via TTB) are **stable**, the PTP modules are beginning their local Master Cock (MCLK) synchronization. Each of max. clocks are synchronized separately to let PTP modules operate autonomous and independent on each other. Each 1-4 module includes own operating system with own IP and PTP stack (IPv4/IPv6). The PTP modules separation is essential for cyber-security.

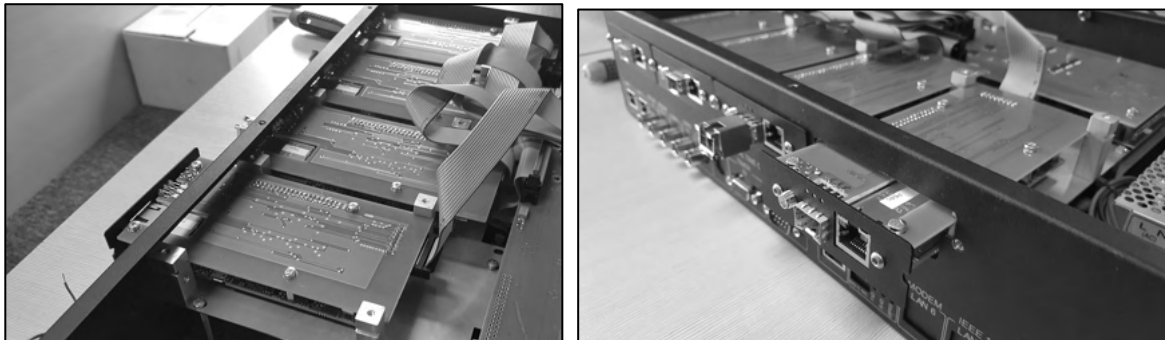

PTP1-PTP4 hardware MCLK (Master Clock PTP) modules in NTS-5000. Each with HW low-level time stamping

**Clk states** variable provides information of local MCLK (Master Clock) synchronization process of PTP module.

**Clk states:** <status>  
status:

- Syncing** – when MC is synchronizing to GMC
- HOLDOVER** – when MC is operating from local TCXO
- FREE** – when MC is operating FREE RUN mode TCXO (MC reminds unsynchronized, e.g. after internal RESET)
- unknown** – shortly after reset of module, or if module is not responding
- Syntonizing** - when MC intervals are syntonizing to ref. interval definition

In addition, the **Clk sync** information is provided and it can be neither **Yes** – if MC is synchronized to GMC, or **No** – if not synchronized. Together, with Clk states it provides full information on PTP module operating autonomous. The synchronized and stable operationally unit mostly displays:

```
Clk states      : Syncing
Clk sync       : Yes
```

where, MC is synchronized to GMC (TTB signals are stable) but it is consciously synchronizing to keep best synchronization accuracy and MC performance. In case of getting PPS or ToD input Unstable, the **Clk states** transfers to **HOLDOVER** (assuming the **Clk sync** was previously **Yes**). Similar situation after module (or unit) reset might conclude with data outputs **Clk states** : **FREE** or earlier directly after reset **Clk states** : **unknown** (assuming the **Clk sync** is **No**). In addition, the **Mode** value parameters can be traced for screen for maintenance tracing:

**mode:** <value>

**value:**

- Master (loop)** – MC is operating (communication is OK), PTP produces ETH output
- Close** – communication PTP module INPUT is close (NO communication)
- Connecting** – GMC is trying to lunch connection to PTP module INPUT
- Read config** – GMC is reading PTP module configuration (communication OK)
- Configuration** – PTP module configuration is pending
- Init** – initializing PTP Expander module
- Booting** – PTP Expander module is booting (restarting)
- Cli wait** – PTP module is waiting for command sent by GMC (Grand Master Clk)

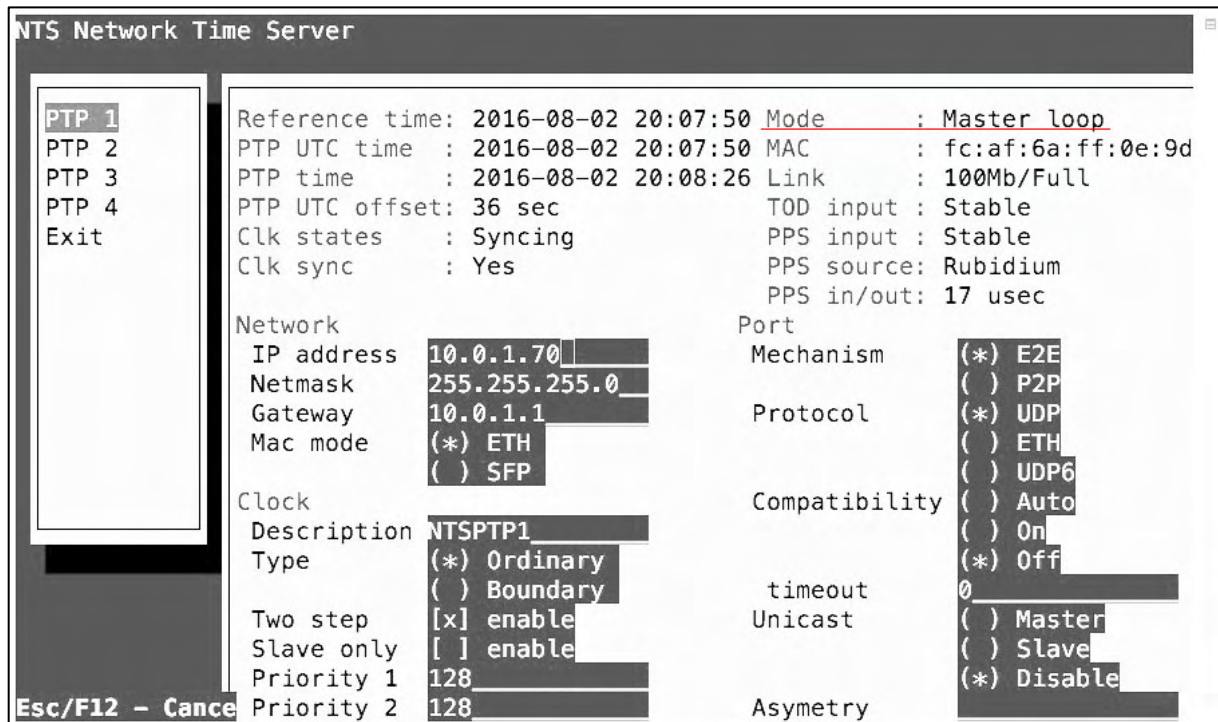

```

NTS Network Time Server
PTP 1
PTP 2
PTP 3
PTP 4
Exit
Reference time: 2016-08-02 20:07:50 Mode : Master loop
PTP UTC time : 2016-08-02 20:07:50 MAC : fc:af:6a:ff:0e:9d
PTP time : 2016-08-02 20:08:26 Link : 100Mb/Full
PTP UTC offset: 36 sec TOD input : Stable
Clk states : Syncing PPS input : Stable
Clk sync : Yes PPS source: Rubidium
PPS in/out: 17 usec
Network Port
IP address 10.0.1.70 Mechanism (* E2E
Netmask 255.255.255.0 ( ) P2P
Gateway 10.0.1.1 Protocol (* UDP
Mac mode (* ) ETH ( ) ETH
( ) SFP ( ) UDP6
Clock Compatibility ( ) Auto
Description NTSP1 ( ) On
Type (* ) Ordinary (* ) Off
( ) Boundary
Two step [x] enable timeout 0
Slave only [ ] enable Unicast ( ) Master
Priority 1 128 ( ) Slave
Priority 2 128 (* ) Disable
Asymetry
Esc/F12 - Cancel

```

Each PTP card provides NIC parameters including MAC and type of Ethernet connection (1GE, 100/10 Mbps).

(1) PTP

```

NTS Network Time Server
PTP 1
PTP 2
PTP 3
PTP 4
Exit
Reference time: 2016-08-02 20:07:50 Mode : Master loop
PTP UTC time : 2016-08-02 20:07:50 MAC : fc:af:6a:ff:0e:9d
PTP time : 2016-08-02 20:08:26 Link : 100Mb/Full
PTP UTC offset: 36 sec TOD input : Stable
Clk states : Syncing PPS input : Stable
Clk sync : Yes PPS source: Rubidium
PPS in/out: 17 usec
Network Port
IP address 10.0.1.70 Mechanism (* E2E
Netmask 255.255.255.0 ( ) P2P
Gateway 10.0.1.1 Protocol (* UDP
Mac mode (* ) ETH ( ) ETH
( ) SFP ( ) UDP6
Clock Compatibility ( ) Auto
Description NTSP1 ( ) On
Type (* ) Ordinary (* ) Off
( ) Boundary
Two step [x] enable timeout 0
Slave only [ ] enable Unicast ( ) Master
Priority 1 128 ( ) Slave
Priority 2 128 (* ) Disable
Asymetry
Esc/F12 - Cancel

```

Above (red colour) marked block defines PTP Clock parameters described in Precision Time Protocol standardization IEEE1588:2008 document. This specification is well done, so there are no reasons to repeat it in this manual. For the std. server operation PTP always claim to work **Ordinary**. In some specific cases PTP card can be configured **Boundary**. The Boundary mode can be selected when clock

is synchronization via PTP/Ethernet and it provides synchronization to PTP/Ethernet. In such mode the **Slave only** option should be selected too. We recommend to keep default **Two step <enable>** and **128 Priority** default set to 128 since those are most std. PTP figures to keep compatibility close.

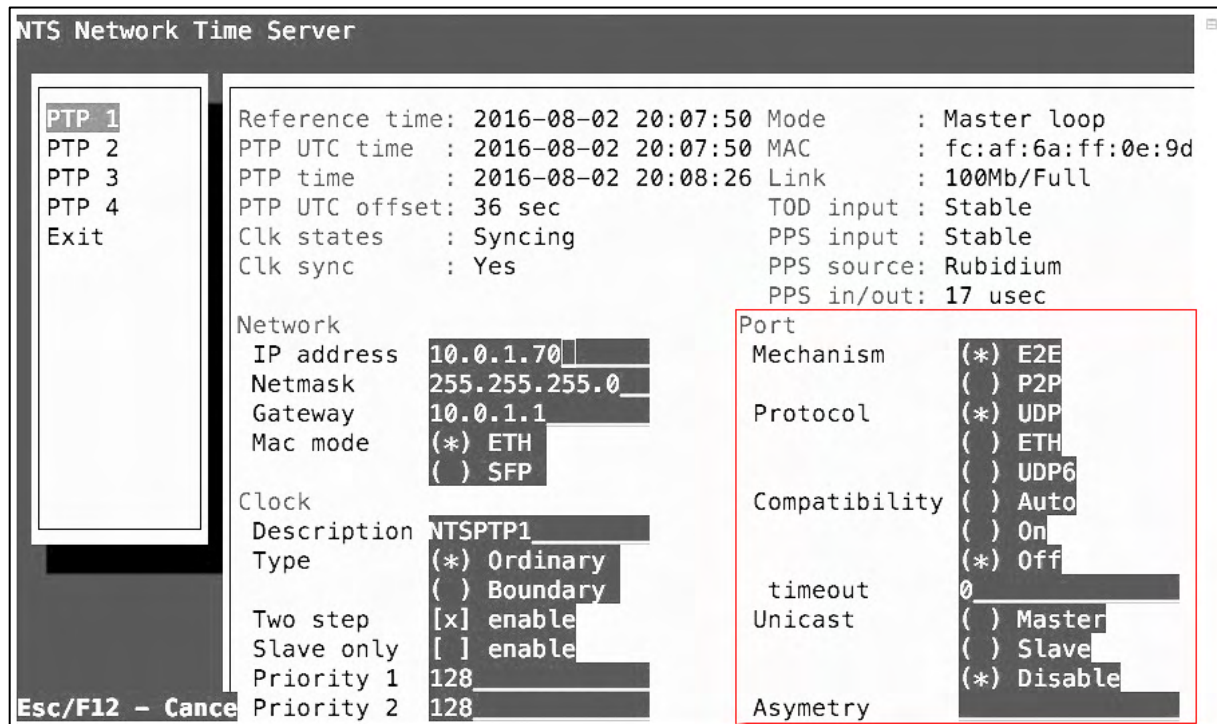

There are two PTP delay measurement **Mechanisms**:

- End-To-End** (E2E - default)
- Peer-To-Peer** (P2P)

The **Peer-To-Peer** (P2P) delay measurement mechanism is best in IT engineered network, where all switches can be guaranteed to be IEEE1588:2008 capable (either transparent clocks or boundary clocks). If there are going to be any non-PTPv2/IEEE1588 aware switches, or if there is any doubt about this, then please use **End-To-End** (E2E) delay measurement mechanism. This is why E2E is also the default mechanism at NTS-5000.

The Precision Time Protocol (PTPv2/IEEE1588:2008) works by exchanging messages between master clocks and slave clock.

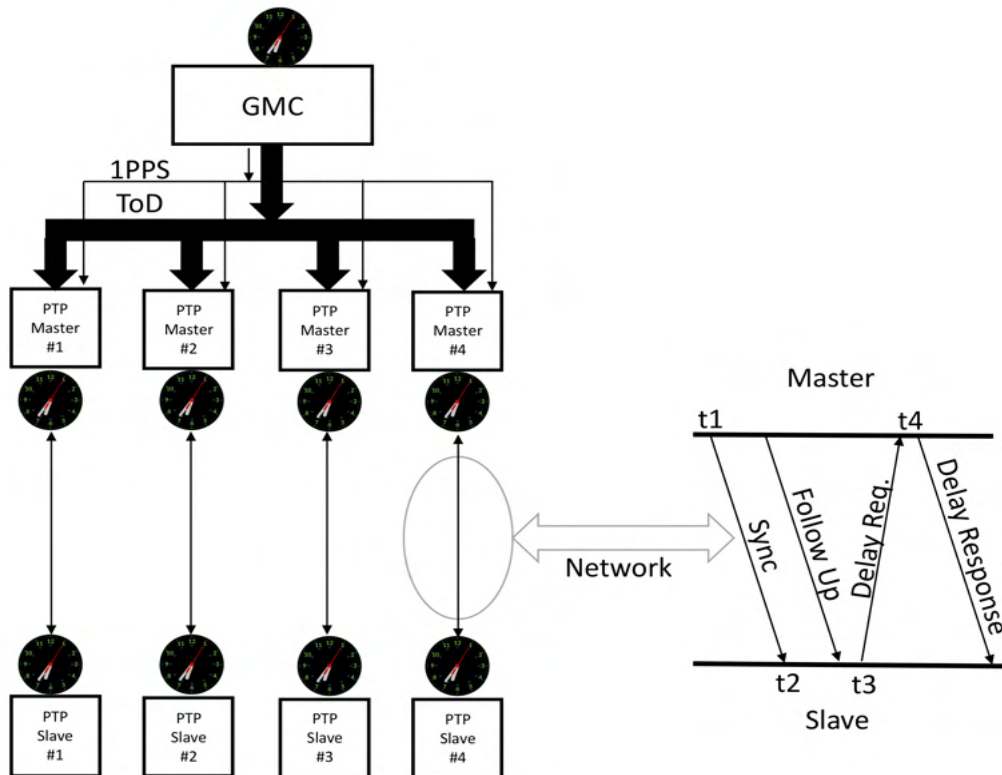

*E2E mechanism*

Above (right side) sequence diagram is showing the exchange of messages between a PTP master clock and a PTP slave clock. For NTS-5000 this process is independent for each of max. 4 PTP masters. The departure and arrival times of the **Sync** and **Delay Request** messages are saved as the four timestamps **t1-t4**. The **Follow Up** and **Delay Response** messages are used to transport the timestamps recorded at the MCLK to the SCLK. Such information is used to adjust slave clock time on the end of these exchanges when SCLK has all four t1-t4 timestamps. It can then calculate the offset of its own clock with respect to the master using following delay averaging formula:

$$\text{Offset} = (t2 + t3 - t1 - t4) / 2$$

The equation assumes that the time it takes for messages to go from the MCLK to SCLK, the forward delay, is the same as the time it takes for messages to go from the slave to the master, the reverse delay. There is no problem if these delays are large, just so long as they are the same. Any difference in the forward and reverse delay results in an error in determining the difference between the master clock and the slave clock.

Why would the forward and reverse delays be different? It's mainly due to all of kind of pesky queues. There are queues in the routers, there are queues in the switches, there are even queues in the network stacks at the end devices. Usually messages spend minimal time in the queues, but sometimes they are waiting for a switch to finish up with other messages on the same port, or for an operating system to complete what it was doing so it can fetch a timestamp. In some cases, the delay can be quite long (to long), many microseconds, or even milliseconds. So obviously if this happens in the one direction, but not the other providing to a big time transfer error.

Basically this is all solved with hardware timestamping when messages depart from or arrive at a network port, special hardware generates a timestamp from the local clock, usually in the media independent interface between the data link layer (MAC) and the physical layer (PHY). That removes the unpredictably slow response of the operating system (OS) and other software (APP, DEV-driver etc). Switches and routers which are PTP aware also timestamp PTP messages. One type of such devices, is called a transparent clock works by updating PTP messages to correct for time spent in the device. Another type, called a boundary clock uses the PTP messages to set its own clock, then sends

its time to PTP slaves which need it. This delay measurement mechanism is known as the **End-to-End** delay measurement mechanism. As it turns out PTP has an alternative delay measurement mechanism known as the **Peer-to-Peer** mechanism.

In **Peer-To-Peer** networks the master still sends Sync and Follow Up messages to the slave clock just as with the end-to-end delay measurement mechanism. With peer-to-peer the slave calculates its clock offset with respect to the master as follows:

$$\text{slave time} = \text{master time} + \text{network delay}$$

No need to combine four timestamps like we did with **End-To-End** networks. But how did the slave know the network delay? That is the **Peer-To-Peer** delay measurement. Instead of sending delay measurement messages from the slave to the master, as with the end-to-end approach, each device on the network exchanges peer-delay measurement messages. That way each device can keep track of the delays between itself and its immediately connected neighbors. Each device periodically initiates an exchange of peer-delay messages on every connected port. Then each device removes the peer-delay from Sync messages when it enters the device, by updating the correction field in either the *Sync* or *Follow Up* message. If it is a switch, it doesn't include the peer-delay in the outgoing cable, even though it also knows that. The next device in the chain will do that correction, and we don't want to double count. The sequence of peer-delay compared to E2E looks:

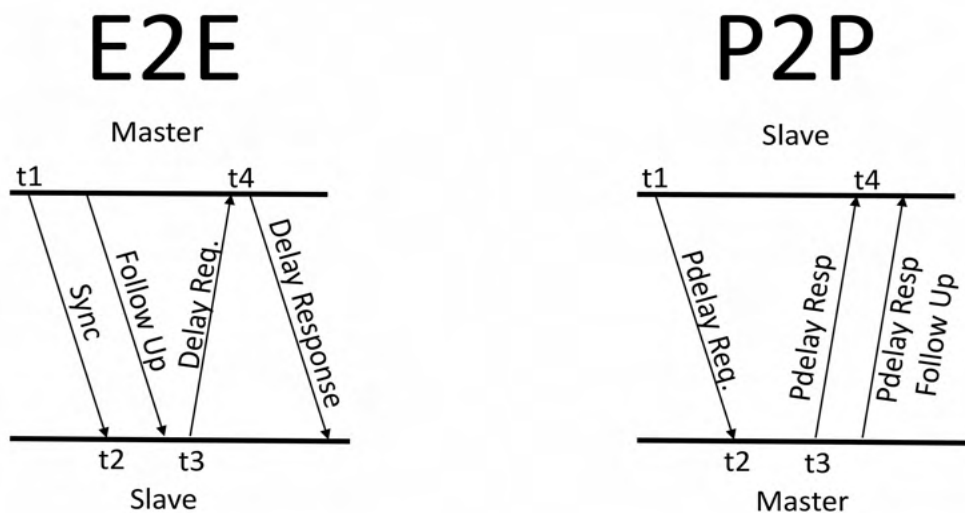

If in P2P model the SCLK wants to know the delay to MCLK, it sends a **Pdelay Req** messages, short for peer-delay request. SCLK also saves the time it sent in t1 message. MCLK saves the time of its clock, when t2 message arrives. Then the MCLK sends a **Pdelay Resp** message, short for peer-delay response, and a **Pdelay Resp Follow Up**. The **Follow Up** message contains the departure time for the **Pdelay Resp**, t3. SCLK also saves the arrival time of the **Pdelay Resp**, t4, so it has all of four timestamps and can calculate the delay between the clocks. Here, as with the end-to-end mechanism, the assumption is made that the time it takes for the peer-delay messages to get from one clock to the other is the same in each direction. In the peer-to-peer case we only making that assumption over a cable, not the whole network, and there are no queues. So unless the cable is very long, that is a good assumption.

What about the queues in the switches? At the beginning of this post I said that peer-to-peer only works well when every switch is either a transparent clock or a boundary clock. That way the switch will take care of its own queuing delays. Another reason that we don't use peer-delay with ordinary switches is that the switches don't know what to do with peer-delay messages, and will not respond to them.

Although the end-to-end mechanism is more versatile, because it can handle ordinary switches and routers, the peer-to-peer mechanism has several advantages in networks where it does work:



- All links are periodically measured, so delay between the master and slave are already known when the network path changes. Note that peer-delay messages are exchanged even on ports blocked to prevent loops, such as by the Rapid Spanning Tree Protocol.
- There is no chance of Sync and Delay\_Request messages taking different paths, since there are no Delay\_Request messages.
- There is no need to worry about the master clocks ability to respond to Delay\_Request messages when there are a lot of slaves, it only has to send the Sync and Follow\_Up.

## 39. NTP symmetric authentication (MD5)

Network Time Protocol (NTP) supports authentication method using symmetric keys (MD5). This functionality is not available for Precision Time Protocol (PTP).

If a packet is sent while using this authentication mode, every packet is provided with a 32-bit key ID and a cryptographic 64/128 bit checksum of the packet. This checksum is built with MD5. With that algorithm the receiving NTP clients validate the checksum. Only NTP client and NTP server using the same pares of MD5 keys will successfully exchange synchronization data and therefore both parties need to have the same crypto key with the same key ID.

### The key file *etc/ntp.keys*

The user must add the key number and the key value to a key file. The file can have any name and be located in any directory, but is usually named *ntp.keys* and is usually located in the same directory as the NTP software and *ntp.conf* configuration file. The *ntp.keys* file includes in each line:

KeyID	EncryptionFormat	KeySequence	#Remarks
-------	------------------	-------------	----------

The first column holds the key ID (digit in range 0-65000). The second column defines the FORMAT. The third column is the MD5 (or DES) key. Supported encryption formats are:

FORMAT "M" - MD5 key with up to 31 ASCII characters  
/Timeservers NTS-3000, 4000, 5000 only supports M format/

FORMAT "A" - DES key with up to eight 7-bit ASCII characters  
/each character is standing for a key octet. This is used by Unix passwords, too./

FORMAT "S" -DES key written in hexadecimal notation,  
/where the lowest bit LSB of each octet is used as the odd parity bit/

FORMAT "N" – DES hexadecimal string,  
/NTP standard format is using the highest bit (HSB) of each octet used as the odd parity bit/

#### Useful remarks:

- Please be aware of the following restrictions of not using "#", TAB, Newline, and NULL as ASCII key.
- The *keyID* 0 is reserved for special purposes and should not appear too.
- The key value must be entered in upper and lower case on both sides (server/client).
- For initial testing purpose please locate *ntp.keys* file in same directory as *ntp.conf* file is.
- For final production keys file should be owned by root and should not be readable by normal users

The *ntp.keys* text ASCII file may look like this:

10	N	29233E0461ECD6AE	# des key in NTP format
20	M	RIrop8KPPvQvYotM	# md5 key as an ASCII random string
14	M	sundial	# md5 key as an ASCII string
15	A	sundial	# des key as an ASCII string
12345	M	BlahBlahBlah	# key can be any ASCII string and any unique KeyID

Following keys are identical:

101	A	SeCReT	# this is ASCII (DES) text
-----	---	--------	----------------------------

```

101 N d3e54352e5548080 # this is HEX (DES) string HSB notation
101 S a7cb86a4cba80101 # this is HEX (DES) string LSB notation

```

In the authentication mode a party is marked “untrusted” (not suitable for synchronization), whenever unauthorized packets (or authorized packets with a wrong key) are used. Please note that a server may recognize a lot of keys but use only a few of them. This allows a time-server to serve a time-client, who is demanding authenticated time-information, without trusting. Additional parameters are used to specify the key IDs for validating the authentic of each partner.

## Configuring the client NTPD daemon for MD5 authentication

In order to use authentication, the following commands must be added to the *ntp.conf* configuration file. These changes should be made after the key has been added to the key file as described above. The symbol “#” introduces a comment (remark), which continues for the remainder of the line. The NTP daemon process must be restarted after the file has been edited.

The configuration file *ntp.conf* of a server using this authentication mode may look like this:

```

server 10.0.0.210 key 10
server 192.168.0.210 key 10
keys <path>/etc/ntp.keys          # UNIX family OS
keys "<path>\etc\ntp.keys"        # MS-WINDOWS
trustedkey 10 15
requestkey 15                    # key (mode 6) for accessing server variables
controlkey 15                    # key (mode 7) for accessing server variables

```

The *keys* parameter indicates the location of the file, in which all symmetric keys are stored. The *trustedkey* line includes all key IDs, which have to be considered (trusted – also called uncompromised). All other keys defined in the *keys* are considered as compromised. This allows re-using already owned keys by just adding their respective key ID to the *trustedkey* parameter. If a key needs to be switched off, it can be removed from this line without removing it from the system. This ensures an easy way to re-activate it later without actually transferring the key again.

The line *requestkey 15* declares the key ID for mode-6 control messages (as described in rfc for NTP), which are used by the *ntpq* utility for example. The *controlkey* parameter is specifying the key used for mode-7 private control messages, for example used by the *ntpd* utility. These keys protect the *ntp* variables against unauthorized modification.

It is helpful to monitor the performance of the NTP daemon to confirm that the authentication algorithm is working as expected. The NTP daemon provides a number of monitoring tools that can be used for this purpose. For example, the *peerstats* command will provide information on the status of the connections to the servers that are being used to synchronize the system time. To enable this report, the following commands would be added to the NTP configuration *ntp.conf* file:

```

#
enable auth
enable monitor
enable stats
#
# turn on reporting of the peer statistics
#
statistics peerstats
#
# the file for the report will be named peerstats with
# the date appended. The full name of the file # will be peerstats.yyyymmdd.
# a new file will be created every day at 0 hours UTC.
#
filegen peerstats file peerstats type day
#

```

```
# the following command specifies the full name of
# the directory where the files will be located
#
statsdir /local/bin/
```

## Testing the keys

1. Any given key can be tested using the utility program *ntpdate* in debug mode (-d options). Running in debug mode will print intermediate results on screen and do not adjust the clock (-a option). The integer specifies the key number (-k option). The xxx.xxx.xxx.xxx is the IP of NTP server. The command is:

```
ntpdate -d -a 12345 -k /local/bin/ntp.keys xxx.xxx.xxx.xxx
```

The NTP server replay should include confirmation sequence:

```
authentication passed transmit(xxx.xxx.xxx.xxx) receive(xxx.xxx.xxx.xxx)
```

If the key number or key value is not correct then the message “*authentication passed*” will be replaced with “*authentication failed.*” If the response shows transmit messages with no corresponding *receive* responses then either the IP address is wrong, *keyID* mismatch or a firewall or network router is blocking the connection to the timeserver. The *ntpdate* always require root (admin) rights.

2. Starting from NTP version 4.2.8 there is *ntpq* new command *authinfo* available for testing and statistic. Please type “?” at *ntpq* prompt command level to see all commands. The *ntpq* can be also executed from shell level. The command is:

```
ntpq -c authinfo
```

It returns statistic of authentication with following detailed data output:

```
time since reset:    21483
stored keys:        2
free keys:          15
key lookups:        2712
keys not found:     0
uncached keys:      1
expired keys:       0
encryptions:        1356
decryptions:        1356
```

Observing in time client “encryptions” and “decryptions” figures ensures that packages are exchanged encrypted. Both parameters should increase each pool interval, but not necessarily (depends on *ntp.conf* configuration and time server availability) both must point the same value.

3. It is helpful to monitor the performance of the NTP daemon to confirm that the authentication algorithm is working as expected. The NTP daemon provides a number of monitoring tools setup in *ntp.conf* :

```
#monitoring lines add to ntp.conf
enable monitor
enable stats
statistics peerstats
filegen peerstats file peerstats type day
statsdir /local/bin/
```

The daemon process will add an entry into the *peerstats* file each time the client queries a server. The entry will be in the following form:

54237 86332.222 132.163.4.107 f624 -0.011106682 0.000251015 0.000953898  
0.000073756

The first two parameters give the time of the query as the MJD (Modified Julian Day number) and the UTC second of the day. The third parameter gives the IP address of the remote system. The fourth parameter describes the state of the query using the hexadecimal representation of a series of bits. The significance of each bit is described in Appendix B of RFC1305. Using the convention that the most significant bit of the state is bit 0, the first hexadecimal digit of the state should be "f" to indicate that:

Bit 0: peer is configured  
Bit 1: authentication is enabled  
**Bit 2: authentication is ok**  
Bit 3: peer is reachable

If authentication is not used, then bits 1 and 2 will be 0, and the first digit will be 9 instead of f. The "6" in the second digit signals that this server is being used to synchronize the local clock. If the client is querying more than one server, then the one that is selected to synchronize the clock will have a 6 as the second digit and the other status words will normally have a 4 in that position. The remaining parameters describe the offset, delay, dispersion, and jitter of the query.

### ntp.conf/ntp.keys examples

*Example configuration for testing NTP for Microsoft Windows 8.1 PRO*

```
# file ntp.conf for Windows 8.1 NTP CLINET
driftfile "C:\Program Files (x86)\NTP\etc\ntp.drift"
enable auth
keys "C:\Program Files (x86)\NTP\etc\ntp.keys"
trustedkey 10101 12345 20 101
requestkey 15
controlkey 15
server 10.0.0.245 iburst minpoll 4 maxpoll 4 key 10101

### EOF ###
```

```
# file ntp.conf for Windows 8.1 NTP SERVER
driftfile "C:\Program Files (x86)\NTP\etc\ntp.drift"
enable auth
keys "C:\Program Files (x86)\NTP\etc\ntp.keys"
trustedkey 10101 12345 20 101
requestkey 15
controlkey 15
server 127.127.1.0 iburst minpoll 4 maxpoll 4
fudge 127.127.1.0 stratum 5 refid WIN8
### EOF ###
```

# file ntp.keys – the same file for both: SERVER & CLIENT

```
10 M ElpromaElectronica1
14 M sundial
15 A sundial
20 N 29233E0461ECD6AE # des key in NTP format
30 M Rlrop8KPPvQvYotM # md5 key as an ASCII random string
12345 M BlahBlahBlah # key can be any ASCII string and any unique KeyID
```

```

101   A SeCReT           # this is ASCII (DES) text
1010  N d3e54352e5548080 # this is HEX (DES) string HSB notation
10101 M a7cb86a4cba80101 # this is HEX (DES) string LSB notation

```

## Configuring authentication at NTS-3000/4000/5000

NTS-3000/4000/5000 authentication can be lunch using std, server setup (HTTP, SSH, TELNET). Timeserver supports MD5 symmetric keys only. Please be sure to save updated configuration and restart NTP client demon or service. It is also recommended to power down NTS-3000/4000/5000 and restart unit before using new defined MD5 symmetric keys.

### MD5 Setup (WWW)

From left menu please select NTP MD5 Keys and write your MD5 ASCII keys to table. The 1-10 column represents KeyID. If you like to store large number KeyID please use Prev/Next buttons. Once your MD5 key configuration (servers ntp.keys) is ready, please save it pressing "Save changes" and wait until confirmation of storing will be displayed. Before using new defined MD5 keys please perform "Save settings" (and wait for success saving confirmation), and Logout. It is recommended to restart time server before using new keys.

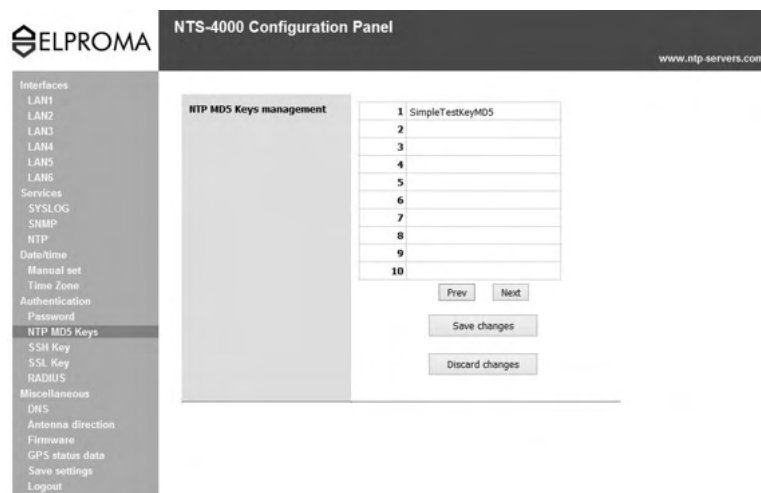

Configuring symmetric MD5 keys via HTTP (example use server IP 10.0.0.249)

Saved configuration creates automatically ntp.keys file inside NTS-3000/4000/5000. Please note keys you have defined for NTS and use them at *ntp.keys/ntp.conf* file of your client. Files may looks like:

```

# ntp.conf file
enable auth
keys "C:\Program Files (x86)\NTP\etc\ntp.keys"
trustedkey 1 15 16
requestkey 16
controlkey 16
server 10.0.0.249 minpoll 4 maxpoll 4 key 1 #KeyID=1 "SimpleTestKeyMD5" in use

# ntp.keys file
1 M SimpleTestKeyMD5
15 M ElpromaKey2
16 M ClepsydraKey3

```

## MD5 Setup (SSH/TELNET)

Below screenshots shows how to configure symmetric MD5 keys using text mode terminal services SSH and Telnet. For secured network environments, it is strongly recommended to use SSH service (not HTTP or Telnet).



```
10.0.0.249 - PuTTY
LAN1
LAN2
SYSLOG
SNMP
NTP
DATE/TIME
TIMEZONE
*AUTH
RADIUS
DNS
MISC
Exit

NTP MD5 keys (0 to end edition)
key number: 1...

SSH -- generate new SSH keys
SSL -- generate new SSL keys
Return -- return to main menu

PASSWD MD5 VIEW SSH SSL Return
```

When defining new or existing MD5 key you will be requested for its KeyID (key number) first.

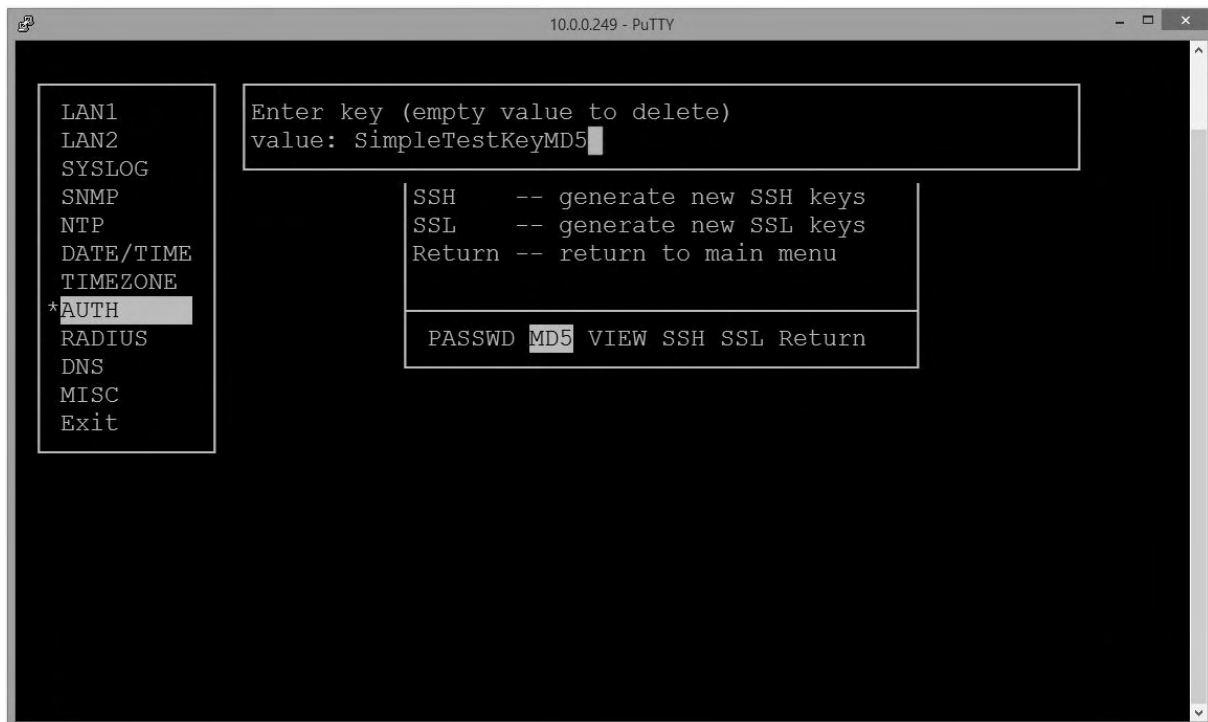

```
10.0.0.249 - PuTTY
LAN1
LAN2
SYSLOG
SNMP
NTP
DATE/TIME
TIMEZONE
*AUTH
RADIUS
DNS
MISC
Exit

Enter key (empty value to delete)
value: SimpleTestKeyMD5

SSH -- generate new SSH keys
SSL -- generate new SSL keys
Return -- return to main menu

PASSWD MD5 VIEW SSH SSL Return
```

You can provide new MD5 key text sequence, modify or remove existing one.

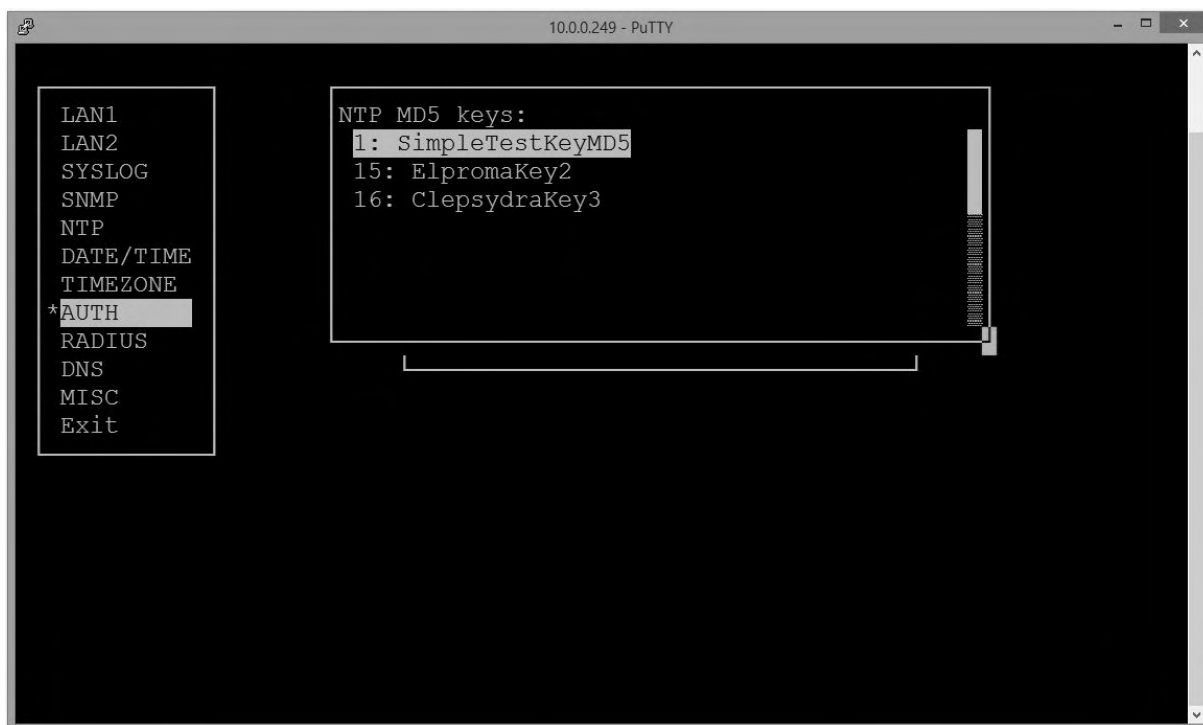

Stored MD5 keys can be viewed. Please use VIEW from AUTH menu to view all defined MD5 keys.



Once all MD5 keys definitions are complete please use RETURN and EXIT with saving setup. All operation will be confirmed on TTY display. We thank you for your patience and please follow those messages until final one. It is recommended to restart your timeserver before using new or modified



MD5 keys. You should also perform to restart your NTP client demon (service) to take effect on changes. Please test your authenticated synchronization first before using in final production environment.

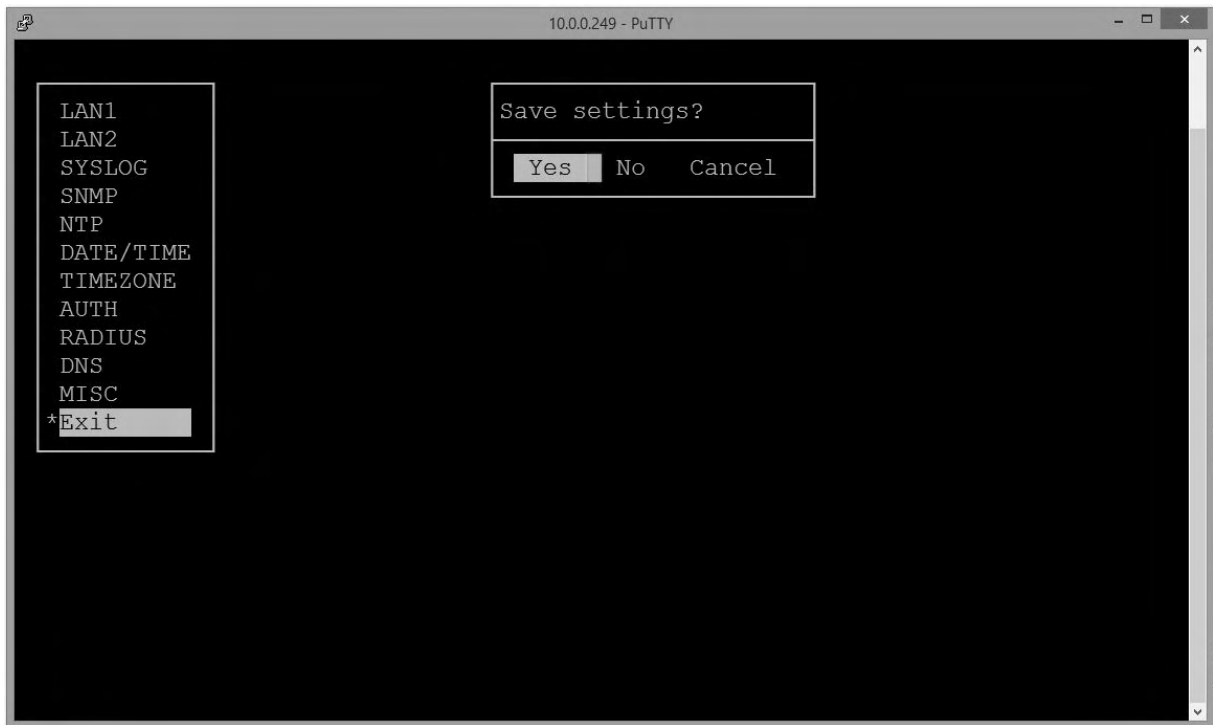

## 40. SYSLOG

**Syslog** is a widely used standard for message logging. It permits separation of the software that generates messages, the system that stores them, and the software that reports and analyses them. Computer system designers can use syslog for system management and security auditing as well as general informational, analysis, and debugging messages. Syslog is a client/server protocol a logging application transmits a text message to the syslog receiver. The receiver is commonly called syslog server. Syslog messages may be sent via the UDP or TCP. The data is sent in clear text. Therefore in some cases port 514 is required to be open.

The screenshot shows the 'NTS-5000 Configuration Panel' with a sidebar menu on the left containing categories like Interfaces, Services, Date/time, Authentication, and Miscellaneous. The 'SYSLOG' option is selected in the Services section. The main configuration area has the following fields:

<b>Service enable</b>	<input checked="" type="checkbox"/> <b>Enabled</b> If this option is set, device will store system logs on remote host
<b>SYSLOG host</b>	<input type="text" value="10.0.0.246"/> <b>OK</b> Enter SYSLOG host IP address here
<b>Facility</b>	<input type="text" value="Original"/> Select facility
<b>Level</b>	<input type="text" value="Emergency"/> Select level

*NTS-3000/4000/5000 SETUP page for defining syslog server address, facility and level*

NTS-3000/4000/5000 supports single syslog server reporting. Multiple syslog server support is possible intermediately using LOG redistribution between syslog servers. NTS3000/4000/5000 is providing standard reporting from most to least severe:

- *Emergency (factory default),*
- *Alert,*
- *Critical,*
- *Error,*
- *Warning,*
- *Notice,*
- *Info,*
- *Debug*

A facility level is used to specify what type of NTS-3000/4000/5000 service is logging the message. This lets the configuration file specify that messages from different facilities will be handled differently. The possible selection are: *Original (factory default – the same as FreeBSD UNIX), demon, syslog, local use from 0 to 7.*

The NTS-3000/4000/5000 sends to syslog following security messages:

- *entering/exiting SETUP locally from front panel keyboard*
- *entering/exiting SETUP remotely using ssh, www, telnet etc*
- *the new source of UTC faze stamping is selected for synchronization (GNSS-NMEA Ant1, GNSS-NMEA Ant2, remote backup NTP servers, LOCAL clock)*

*Note ! Frequency ref. as 1PPS (GNNS, EXT, IRIG-B, SYSPLEX) as well as internal build-in OSC (OCXO, Rubidium) will not trig LOG message report when synchronized to. It is because 1PPS is just a*

frequency std. and it is not providing any UTC time stamping information (UTC date & time). It performs high accuracy frequency tuning possible only once time server is locked (PLL/FLL) to source as Ant1, Ant2 or remote backup NTP server.

## Entering/exiting SETUP locally from front panel keyboard

Date	Time	Priority	Hostname	Message
02-14-2015	22:56:09	Auth.Info	10.0.0.244	Feb 14 21:56:09 sshd[4891]: Server listening on 0.0.0.0 port 22.
02-14-2015	22:56:09	Syslog.Info	10.0.0.244	Feb 14 21:56:09 rsyslogd: [origin software="rsyslogd" swVersion="3.20.0" x-pid="3645" x-info="http://www.rsyslog.com"] restart
02-14-2015	22:56:08	Daemon.Notice	10.0.0.244	Feb 14 21:56:08 NTS-FrontPanel: Saving changes setup
02-14-2015	22:55:55	Auth.Info	10.0.0.244	Feb 14 21:55:55 sshd[3190]: Received signal 15: terminating.
02-14-2015	22:55:55	Syslog.Info	10.0.0.244	Feb 14 21:55:55 rsyslogd: [origin software="rsyslogd" swVersion="3.20.0" x-pid="3645" x-info="http://www.rsyslog.com"] restart
02-14-2015	22:55:55	Daemon.Notice	10.0.0.244	Feb 14 21:55:55 NTS-FrontPanel: Enter to setup

*Accessing SETUP from keyboard (without saving changes)*

Date	Time	Priority	Hostname	Message
02-14-2015	22:59:10	Auth.Info	10.0.0.244	Feb 14 21:59:10 sshd[5046]: Server listening on 0.0.0.0 port 22.
02-14-2015	22:59:10	Syslog.Info	10.0.0.244	Feb 14 21:59:10 rsyslogd: [origin software="rsyslogd" swVersion="3.20.0" x-pid="3645" x-info="http://www.rsyslog.com"] restart
02-14-2015	22:59:08	Daemon.Notice	10.0.0.244	Feb 14 21:59:08 NTS-FrontPanel: Changes not saved
02-14-2015	22:58:55	Auth.Info	10.0.0.244	Feb 14 21:58:55 sshd[4891]: Received signal 15: terminating.
02-14-2015	22:58:55	Syslog.Info	10.0.0.244	Feb 14 21:58:55 rsyslogd: [origin software="rsyslogd" swVersion="3.20.0" x-pid="3645" x-info="http://www.rsyslog.com"] restart
02-14-2015	22:58:55	Daemon.Notice	10.0.0.244	Feb 14 21:58:55 NTS-FrontPanel: Enter to setup

*Accessing SETUP from keyboard (saving changes)*

## Entering/exiting SETUP remotely using ssh/www/telnet and other protocols or utility

Date	Time	Priority	Hostname	Message
02-14-2015	23:05:35	User.Info	10.0.0.244	Feb 14 22:05:35 www_setup: Enter to NTS-SETUP (www)
02-14-2015	23:05:26	Syslog.Info	10.0.0.244	Feb 14 22:05:26 rsyslogd: [origin software="rsyslogd" swVersion="3.20.0" x-pid="3645" x-info="http://www.rsyslog.com"] restart start
02-14-2015	23:04:17	User.Info	10.0.0.244	Feb 14 22:04:17 -nowy_setup: Old setting restored NTS-SETUP (ssh/telnet)
02-14-2015	23:04:06	User.Info	10.0.0.244	Feb 14 22:04:06 -nowy_setup: Enter NTS-SETUP (ssh/telnet)
02-14-2015	23:04:05	Syslog.Info	10.0.0.244	Feb 14 22:04:05 rsyslogd: [origin software="rsyslogd" swVersion="3.20.0" x-pid="3645" x-info="http://www.rsyslog.com"] restart start
02-14-2015	23:04:04	Auth.Info	10.0.0.244	Feb 14 22:04:04 sshd[5320]: Accepted keyboard-interactive/pam for admin from 10.0.0.246 port 56602 ssh2

*Accessing SETUP from SSH (saving changes)*

## New NMEA UTC source of time stamping

Date	Time	Priority	Hostname	Message
02-14-2015	23:39:37	System2.Notice	10.0.0.244	Feb 14 22:39:37 ntpd[1831]: kernel time sync status change 2001
02-14-2015	23:39:37	System2.Notice	10.0.0.244	Feb 14 22:39:37 ntpd[1831]: time reset +0.833924 s
02-14-2015	23:39:37	System2.Info	10.0.0.244	Feb 14 22:39:37 ntpd[1831]: synchronized to GPS NMEA antenna 2, stratum 1

*This message is sent each time NMEA UTC timestamp new source is selected. Message is not generated for frequency tuning std. as 1PSS*

## Indicating LOCAL clock operation

Date	Time	Priority	Hostname	Message
02-14-2015	23:14:33	System2.Notice	10.0.0.244	Feb 14 22:14:32 ntpd[459]: kernel time sync status change 2001
02-14-2015	23:14:33	System2.Info	10.0.0.244	Feb 14 22:14:32 ntpd[459]: synchronized to LOCAL(0), stratum 5

*NTS-3000/4000/5000 is synchronized to NTP LOCAL CLOCK. This situation can periodically (temporary) be noted in LOG when switching between UTC sources. It is requiring than Admin inspection (eg. via NTP tool "ntpq.exe -pe") to check current status of Ant1/Ant2.*

## Missing UTC source for time server

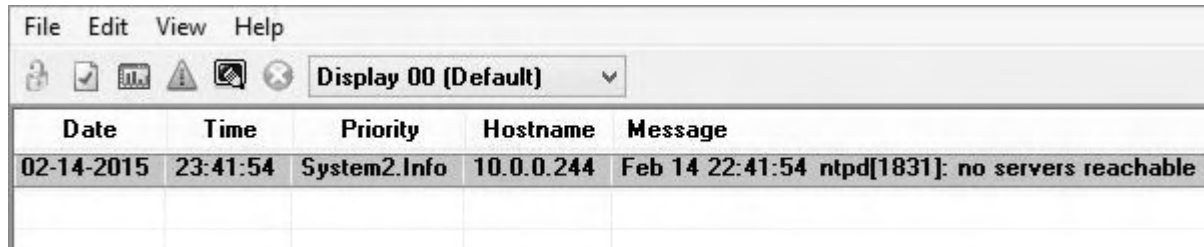

The screenshot shows a log viewer window with a menu bar (File, Edit, View, Help) and a toolbar with icons for search, refresh, and other functions. A dropdown menu is set to 'Display 00 (Default)'. The log table has five columns: Date, Time, Priority, Hostname, and Message. One entry is visible:

Date	Time	Priority	Hostname	Message
02-14-2015	23:41:54	System2.Info	10.0.0.244	Feb 14 22:41:54 ntpd[1831]: no servers reachable

*NTS-3000/4000/5000 is missing source of UTC time. This situation might happen when all antennas are disconnected and server configuration has disabled OSC (OCXO, Rubidium) and LOCAL clock.*

## Simple LOG sequence after power up timeserver

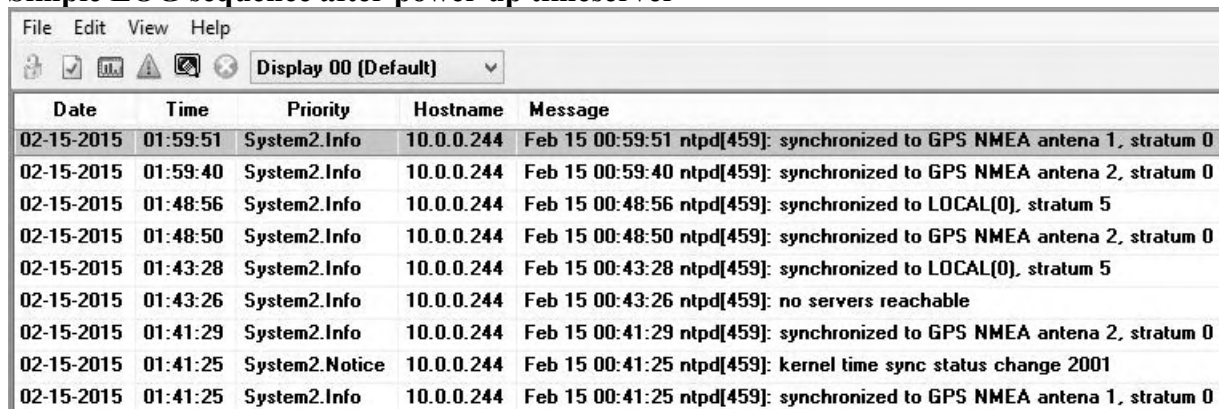

The screenshot shows a log viewer window with a menu bar (File, Edit, View, Help) and a toolbar. A dropdown menu is set to 'Display 00 (Default)'. The log table has five columns: Date, Time, Priority, Hostname, and Message. Multiple entries are visible:

Date	Time	Priority	Hostname	Message
02-15-2015	01:59:51	System2.Info	10.0.0.244	Feb 15 00:59:51 ntpd[459]: synchronized to GPS NMEA antenna 1, stratum 0
02-15-2015	01:59:40	System2.Info	10.0.0.244	Feb 15 00:59:40 ntpd[459]: synchronized to GPS NMEA antenna 2, stratum 0
02-15-2015	01:48:56	System2.Info	10.0.0.244	Feb 15 00:48:56 ntpd[459]: synchronized to LOCAL(0), stratum 5
02-15-2015	01:48:50	System2.Info	10.0.0.244	Feb 15 00:48:50 ntpd[459]: synchronized to GPS NMEA antenna 2, stratum 0
02-15-2015	01:43:28	System2.Info	10.0.0.244	Feb 15 00:43:28 ntpd[459]: synchronized to LOCAL(0), stratum 5
02-15-2015	01:43:26	System2.Info	10.0.0.244	Feb 15 00:43:26 ntpd[459]: no servers reachable
02-15-2015	01:41:29	System2.Info	10.0.0.244	Feb 15 00:41:29 ntpd[459]: synchronized to GPS NMEA antenna 2, stratum 0
02-15-2015	01:41:25	System2.Notice	10.0.0.244	Feb 15 00:41:25 ntpd[459]: kernel time sync status change 2001
02-15-2015	01:41:25	System2.Info	10.0.0.244	Feb 15 00:41:25 ntpd[459]: synchronized to GPS NMEA antenna 1, stratum 0

*Good weather conditions*

Below screenshot illustrates LOG example when bad weather conditions are and there are problems in receiving SAT signals.

Date	Time	Priority	Hostname	Message
02-15-2015	11:05:53	System2.Info	10.0.0.244	Feb 15 10:05:53 ntpd[455]: synchronized to GPS NMEA antena 2, stratum 0
02-15-2015	11:05:51	System2.Info	10.0.0.244	Feb 15 10:05:51 ntpd[455]: synchronized to 10.0.1.215, stratum 1
02-15-2015	11:03:43	System2.Info	10.0.0.244	Feb 15 10:03:43 ntpd[455]: synchronized to LOCAL(0), stratum 5
02-15-2015	11:03:25	System2.Info	10.0.0.244	Feb 15 10:03:25 ntpd[455]: synchronized to GPS NMEA antena 1, stratum 0
02-15-2015	11:02:36	System2.Info	10.0.0.244	Feb 15 10:02:36 ntpd[455]: synchronized to GPS NMEA antena 1, stratum 0
02-15-2015	11:02:35	System2.Info	10.0.0.244	Feb 15 10:02:35 ntpd[455]: synchronized to LOCAL(0), stratum 5
02-15-2015	11:01:47	System2.Info	10.0.0.244	Feb 15 10:01:47 ntpd[455]: synchronized to LOCAL(0), stratum 5
02-15-2015	11:00:57	System2.Info	10.0.0.244	Feb 15 10:00:57 ntpd[455]: synchronized to LOCAL(0), stratum 5
02-15-2015	10:59:52	System2.Info	10.0.0.244	Feb 15 09:59:52 ntpd[455]: synchronized to LOCAL(0), stratum 5
02-15-2015	10:59:02	System2.Info	10.0.0.244	Feb 15 09:59:02 ntpd[455]: synchronized to GPS NMEA antena 2, stratum 0
02-15-2015	10:58:47	System2.Info	10.0.0.244	Feb 15 09:58:47 ntpd[455]: synchronized to LOCAL(0), stratum 5
02-15-2015	10:37:27	System2.Info	10.0.0.244	Feb 15 09:37:27 ntpd[455]: synchronized to LOCAL(0), stratum 5
02-15-2015	10:12:05	System2.Info	10.0.0.244	Feb 15 09:12:05 ntpd[455]: synchronized to GPS NMEA antena 1, stratum 0
02-15-2015	10:12:01	System2.Info	10.0.0.244	Feb 15 09:12:01 ntpd[455]: synchronized to GPS NMEA antena 2, stratum 0
02-15-2015	10:11:50	System2.Info	10.0.0.244	Feb 15 09:11:50 ntpd[455]: synchronized to GPS NMEA antena 1, stratum 0
02-15-2015	10:11:46	System2.Info	10.0.0.244	Feb 15 09:11:46 ntpd[455]: synchronized to GPS NMEA antena 2, stratum 0
02-15-2015	10:11:35	System2.Info	10.0.0.244	Feb 15 09:11:35 ntpd[455]: synchronized to GPS NMEA antena 1, stratum 0
02-15-2015	10:11:17	System2.Info	10.0.0.244	Feb 15 09:11:17 ntpd[455]: synchronized to GPS NMEA antena 2, stratum 0
02-15-2015	10:10:23	System2.Notice	10.0.0.244	Feb 15 09:10:23 ntpd[455]: time reset -1679.806025 s
02-15-2015	10:10:03	System2.Info	10.0.0.244	Feb 15 09:38:02 ntpd[455]: synchronized to GPS NMEA antena 2, stratum 0
02-15-2015	10:09:16	System2.Info	10.0.0.244	Feb 15 09:37:15 ntpd[455]: synchronized to GPS NMEA antena 1, stratum 0
02-15-2015	10:09:15	System2.Info	10.0.0.244	Feb 15 09:37:14 ntpd[455]: synchronized to GPS NMEA antena 2, stratum 0
02-15-2015	10:09:01	System2.Info	10.0.0.244	Feb 15 09:37:00 ntpd[455]: synchronized to GPS NMEA antena 1, stratum 0
02-15-2015	10:08:59	System2.Info	10.0.0.244	Feb 15 09:36:58 ntpd[455]: synchronized to GPS NMEA antena 2, stratum 0
02-15-2015	10:08:45	System2.Info	10.0.0.244	Feb 15 09:36:44 ntpd[455]: synchronized to GPS NMEA antena 1, stratum 0
02-15-2015	10:08:44	System2.Info	10.0.0.244	Feb 15 09:36:43 ntpd[455]: synchronized to GPS NMEA antena 2, stratum 0
02-15-2015	10:08:14	System2.Info	10.0.0.244	Feb 15 09:36:13 ntpd[455]: synchronized to GPS NMEA antena 1, stratum 0
02-15-2015	10:07:41	System2.Info	10.0.0.244	Feb 15 09:35:40 ntpd[455]: synchronized to GPS NMEA antena 2, stratum 0
02-15-2015	10:07:11	System2.Info	10.0.0.244	Feb 15 09:35:11 ntpd[455]: synchronized to GPS NMEA antena 1, stratum 0
02-15-2015	10:06:18	System2.Info	10.0.0.244	Feb 15 09:34:17 ntpd[455]: synchronized to GPS NMEA antena 2, stratum 0
02-15-2015	10:06:07	System2.Info	10.0.0.244	Feb 15 09:34:07 ntpd[455]: synchronized to GPS NMEA antena 1, stratum 0
02-15-2015	10:05:24	System2.Info	10.0.0.244	Feb 15 09:33:23 ntpd[455]: synchronized to GPS NMEA antena 2, stratum 0
02-15-2015	10:03:57	System2.Info	10.0.0.244	Feb 15 09:31:57 ntpd[455]: synchronized to GPS NMEA antena 1, stratum 0
02-15-2015	10:03:25	System2.Info	10.0.0.244	Feb 15 09:31:24 ntpd[455]: synchronized to GPS NMEA antena 2, stratum 0
02-15-2015	10:02:34	System2.Info	10.0.0.244	Feb 15 09:30:33 ntpd[455]: synchronized to GPS NMEA antena 1, stratum 0
02-15-2015	10:02:20	System2.Info	10.0.0.244	Feb 15 09:30:19 ntpd[455]: synchronized to GPS NMEA antena 2, stratum 0
02-15-2015	10:01:49	System2.Info	10.0.0.244	Feb 15 09:29:49 ntpd[455]: synchronized to GPS NMEA antena 1, stratum 0
02-15-2015	10:01:46	System2.Info	10.0.0.244	Feb 15 09:29:45 ntpd[455]: synchronized to GPS NMEA antena 2, stratum 0
02-15-2015	10:01:45	System2.Info	10.0.0.244	Feb 15 09:29:44 ntpd[455]: synchronized to GPS NMEA antena 1, stratum 0

*Bad weather conditions (missing SAT signals or GNSS signal is unstable)*

*Important note !* Each time LOCAL clock message is the last status written to LOG the inspection via std. NTP tool “ntpq -pe” is recommended to check antennas and internal oscillators. This situation does not necessary mean emergency call since there is a high probability server reminds FLL (frequency locked) to 1PPS of NMEA GNSS (Ant1 or Ant2). If next LOG message confirms new synchronization source to NMEA (see above example on the top) there are no needs to verify LOCAL clock action.

# 41. Application notes HFT (MiFID II)

Below scheme presents recommendation of UTC time distribution via PTP based on NTS5000 HFT equipped with 4x PTPv2/IEEE1588 hardware cards. Solution warrants following properties:

- 1) All traders work in same UTC time domain (robust synchronization)
- 2) Multit source time ref. provides robust UTC synchronization. Time is driven simultaneously from GNSS and NTA (NMI).
- 3) Each trader has own independent PTPv2/IEEE1588 synchronization line, so traders cannot interfere each other synchronization (traffic problem and its impact to PTP). Each trader PTP synchronization creates kind of “synchronization umwelt”. Each PTP Master has own IP stack, own OS driven. There is no communication between PTP masters inside NTS-5000. The Grand Master NTS-5000 supports synchronization to all trader “synchronization umwelts” – and they all work in same UTC time domain powered by robust synchronization.
- 4) Each trader PTP slave should consider to support:
  - a) NIC 1PPS-out for hardware monitoring (SDH). 1PPS-output should be considered to be compared to ref. 1PPS(k). All monitored data, incl. transaction LOG should be cryptographically timestamped RFC3161
  - b) Solution can be considered to use software level NTP/PTP monitoring (e.g. FSMLab Time Keeper). This is independent on NTA 1PPS hardware validation. All output audit data should be stored in LOG files, cryptographically RFC3161 timestamped, and archived for future AUDIT.

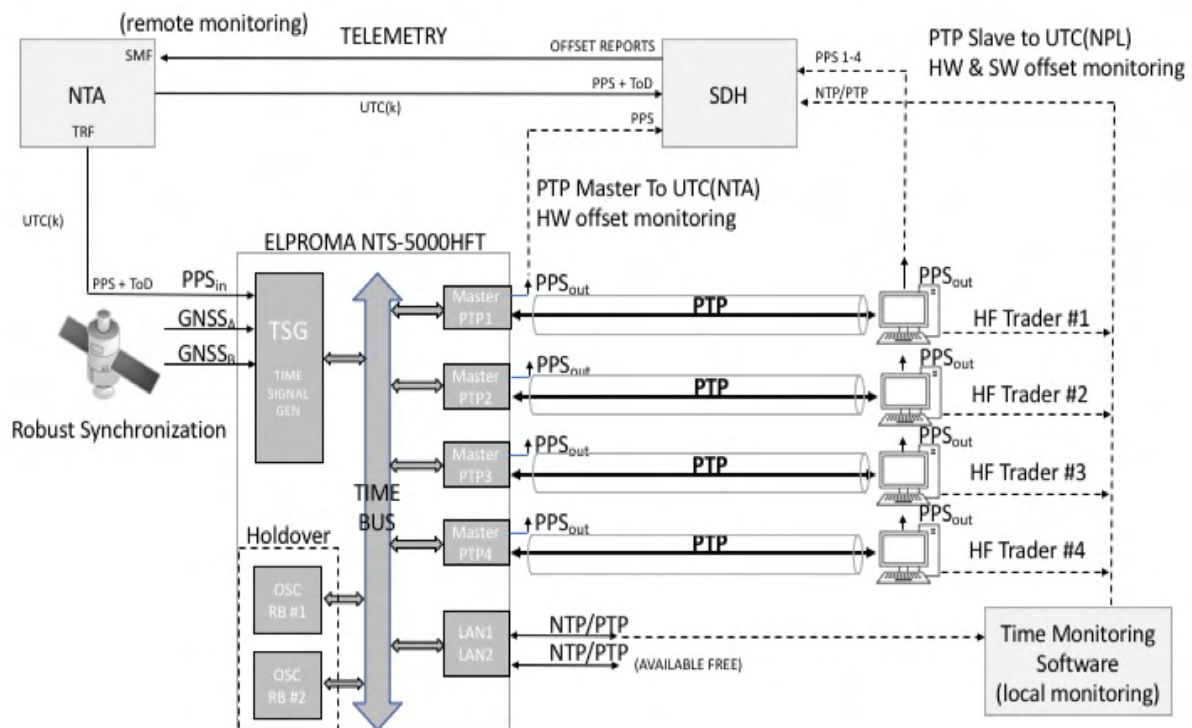

Example of Stock Exchange HFT synchronization system supporting 4 high speed traders

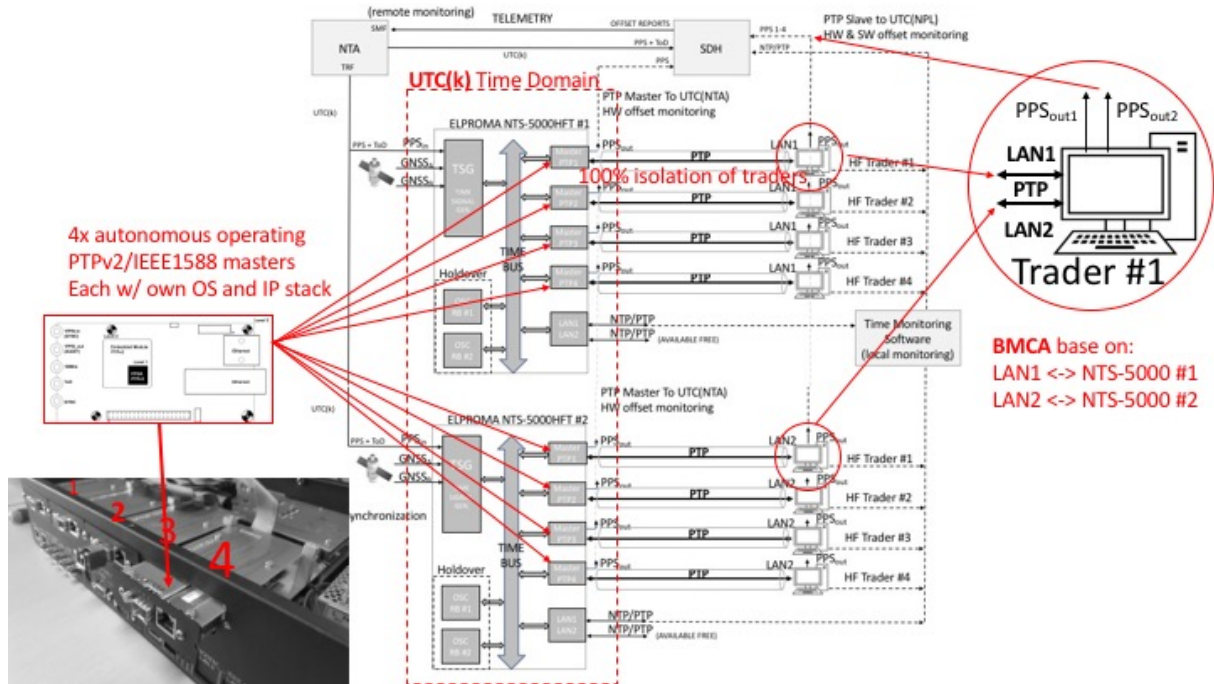

Example of Stock Exchange HFT synchronization system supporting two redundant NTS-5000HFT servers

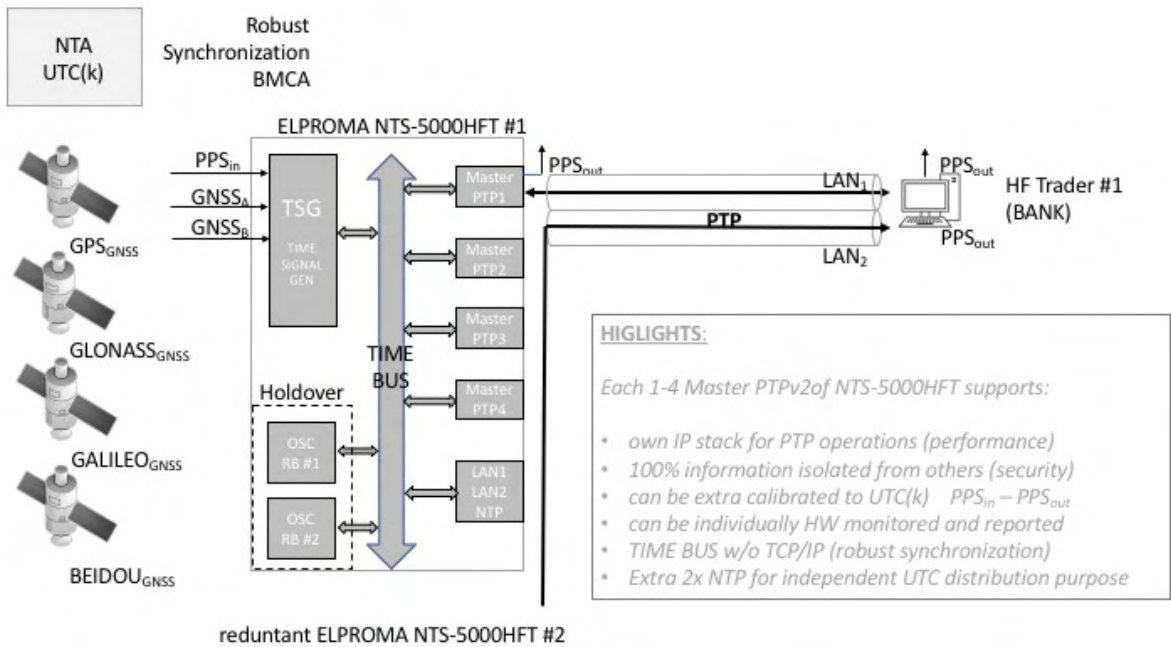

redundant ELPRONA NTS-5000HFT #2

Example of connecting PTP slave to NTS-5000HFT

Above configuration was tested w/ std. M1000 PTP Slave on distance 50km achieving synchronization accuracy of 60ns with jitter +/- 10ns. Below data presents Time Deviation (TDEV) and Allan Deviation (ADEV) plots from December/January 2017 testing at London NPL.

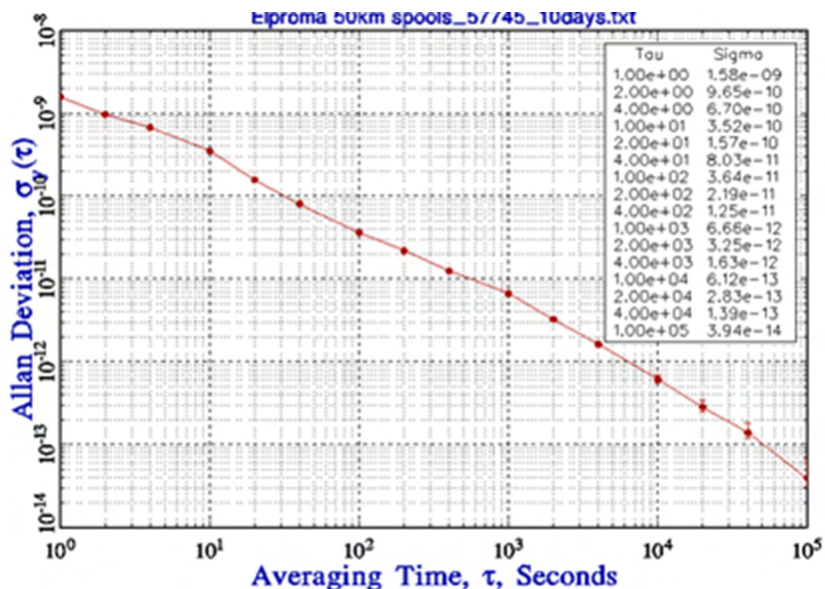
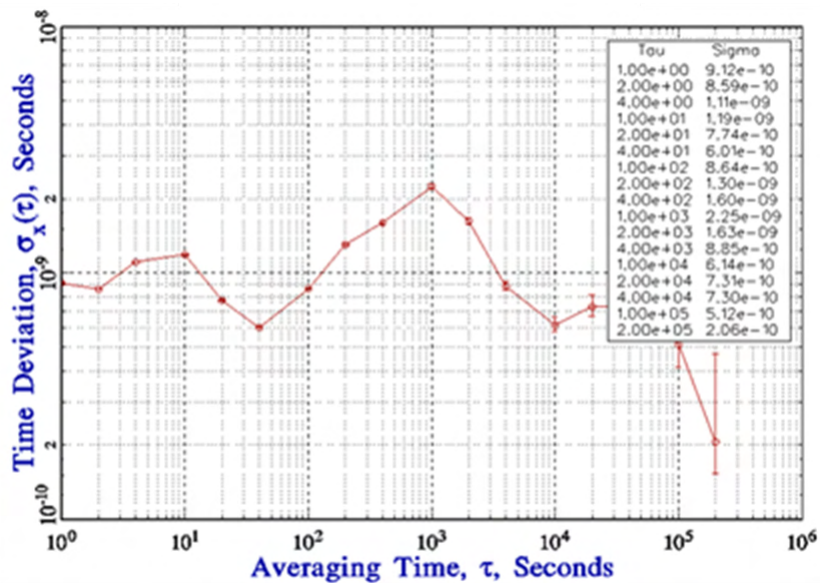





## **USER GUIDE & TUTORIALS**

# **Tutorial**

## 42. PTP (Precision Time Protocol) IEEE1588

The Precision Time Protocol (PTP) IEEE 1588 is designed to synchronize real-time clocks in LANs used for telecommunications, power grids, financial market, and industrial automation. Especially protocol is currently employed to synchronize financial HFT transactions, mobile phone tower transmissions LTE/5G BTS, sub-sea acoustic arrays, and any networks that require precise timing but lack access to GNSS time reference.

Typical accuracies achieved on a high-speed, multiple-segment LAN are within 100 ns and in some cases much better. Version 1 of the PTP was published in 2002. Version 2 was published in 2008 and it is not backward compatible. Shortly it is expected a new PTP IEEE1588 version 2.1

The PTP messages use the User Datagram Protocol over Internet Protocol (UDP/IP) for transport. Version 1 IEEE1588-2002 uses only IPv4 transports, but this has been extended to include IPv6 in IEEE1588-2008 specification. In PTPv1 IEEE1588-2002, all PTP messages are sent using multicast messaging, while PTPv2 IEEE1588-2008 introduced an option for devices to negotiate unicast transmission on a port-by-port basis. Multicast transmissions use IP multicast addressing, for which multicast group addresses are defined for IPv4 and IPv6.

*Event* messages are sent to port number 319.

*General* messages use port number 320.

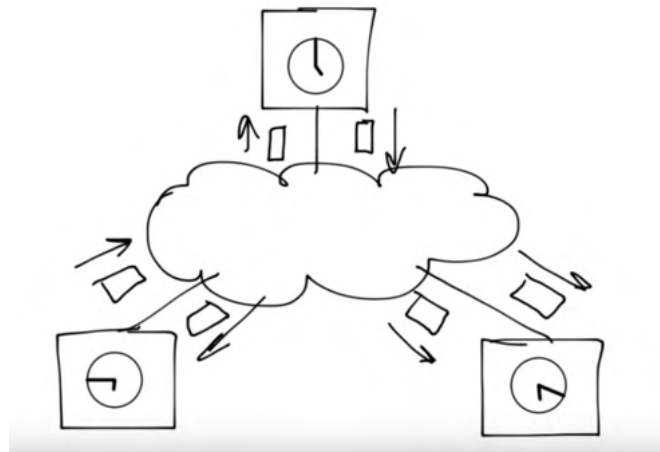

*Terminal and Network Devices*

The IEEE 1588 standards describe a hierarchical master-slave architecture for clock distribution

A 1588 clock is an oscillator, usually a temperature-compensated crystal oscillator (TCXO), and a counter that represents time in seconds and nanoseconds since 0 h 1 January 1970. The intended timescale is International Atomic Time (TAI) with provisions for the UTC offset and advance notice of leap seconds. The time representation is similar to POSIX, except the PTP seconds field has 48 bits, making the timestamp 10 octets long.

## . How many Slaves supports PTP Master?

The short answer: It depends....

A slightly longer answer: The NTS-5000 PTP IEEE1588 expander cards (LAN3 and above) are designs can handle approx. 350 outgoing PTP messages per second. In Multicast this means that:

$$s + d * n < 350 \text{ or } n < (350 - s) / d$$

Where s is the number of sync messages (one-step) per second, d is the number of delay request messages per second and n is the number of slaves. We also have the announce messages, but these are usually kept at a very low rate, so it does not really matter. Assuming the rates are the same for sync and delay request this means:

- 1/sec: 349, but we say 250 to be safe. It depends a lot on how well the slaves distribute their delay requests over time.
- 2/sec: 174
- 32/sec: 9 (tested in our lab)
- 64/sec: 4 (tested in our lab)

In Unicast the formula is:

$$(s + d + a) * n < 350 \text{ or } n < 350 / (s + d + a)$$

Where s is the number of sync messages (one-step) per second, d is the number of delay request messages per second, a is number of announce messages per second and n is the number of slaves. Assuming the rates are the same for sync and delay request and the default announce rate of 1 every two seconds):

- 1/sec: 140
- 2/sec: 77
- 16/sec: 10 (tested in our lab)
- 32/sec: 5 (tested in our lab)
- 64/sec: 2 (tested in our lab)

Now, this is theoretical calculations (although practically verified to some extent) so keep that in mind and use a sound margin to any numbers.

Another thing of great importance, is that our concept of Edge Grandmasters and Gateway clocks significantly reduces the need of high message rates, due to the fact that these devices will be much closer to the clients, with less complex networks in between. 16 msg/s or less should be sufficient in most cases.

## 43. Software Time Protocols

STRATUM-0 UTC ref. time - The Clocks

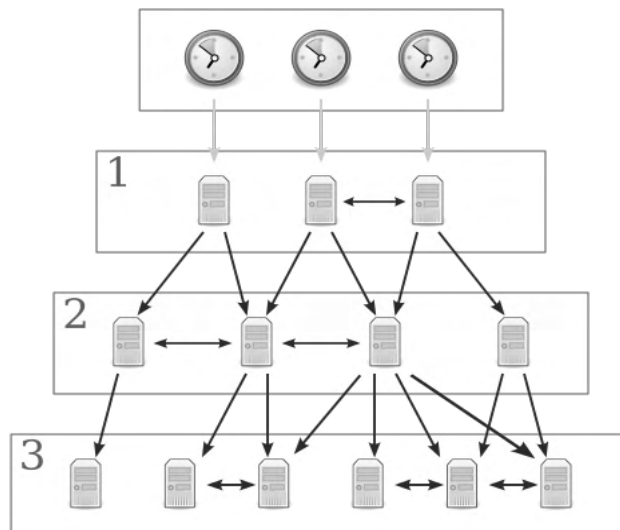

NTP structure is organized in 0-15 level STRATA tree. Beginning from Stratum 2 each computer acts client to STRATUM-1 server and server for STRATUM-3. Servers can PEER providing redundancy and improving robustness of synchronization. Other protocols as SNTP and PTP do not support STRATUM hierarchy. They operate CLIENT-SERVER (Master-Slave) structure only.

### NTP – Network Time Protocol

**Network Time Protocol (NTP)** is a networking protocol for clock synchronization between computer systems over packet-switched, variable-latency data networks. In operation since before 1985, NTP is one of the oldest and stable Internet protocols in current use. NTP was designed by David L. Mills of the University of Delaware.

NTP is intended to synchronize all participating computers operating over public Internet to within a few milliseconds of Coordinated Universal Time (UTC). Using NTP's family of products this accuracy can be improved inside local networks up to level of tens of microseconds.

NTP uses the intersection algorithm, a modified version of Marzullo algorithm, to select accurate time servers and is designed to mitigate the effects of variable network latency. This algorithm is also used to detect time manipulations if several time servers are available as primary reference of time.

NTP uses a hierarchical 0-15, semi-layered system of time sources. Each level of this hierarchy is termed a *stratum* and is assigned a number starting with zero for the reference clock at the top. A server synchronized to a stratum  $n$  server runs at stratum  $n + 1$ . The number represents the distance from the reference clock and is used to prevent cyclical dependencies in the hierarchy.

***Important Note!*** Stratum is not always an indication of quality or reliability

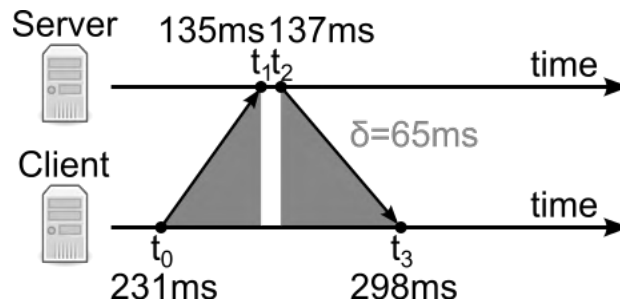

A typical NTP client will regularly poll three or more servers on diverse networks. To synchronize its clock, the client must compute its time offset and round-trip delay. Time offset  $\theta$  is defined by

$$\theta = \frac{(t_1 - t_0) + (t_2 - t_3)}{2}$$

and the round-trip delay  $\delta$  by

$$\delta = (t_3 - t_0) - (t_2 - t_1)$$

Where:

- t0** is the client's timestamp of the request packet transmission,
- t1** is the server's timestamp of the request packet reception,
- t2** is the server's timestamp of the response packet transmission and
- t3** is the client's timestamp of the response packet reception

The values for  $\theta$  and  $\delta$  are passed through filters and subjected to statistical analysis. Outliers are discarded and an estimate of time offset is derived from the best three remaining candidates. The clock frequency is then adjusted to reduce the offset gradually, creating a feedback loop.

The synchronization is correct when both the incoming and outgoing routes between the client and the server have symmetrical nominal delay. If the routes do not have a common nominal delay, there will be a systematic bias of half the difference between the forward and backward travel times.

## . **SNTP - Simple Network Time Protocol**

SNTP (Simple Network Time Protocol) and NTP (Network Time Protocol) are describing exactly the same network package format, the differences can be found in the way how a system deals with the content of these packages in order to synchronize its time. They are basically two different ways of how to deal with time synchronization. It is especially important for client side - responsible for accuracy, security and stability of synchronization.

Compering to NTP, the SNTP does not support multisource and cryptographic authentication.

While a full featured NTP client reaches a very high level of accuracy and avoids abrupt timesteps as much as possible by using different mathematical and statistical methods and smooth clock speed adjustments, SNTP client can only be recommended for simple applications, where the requirements for accuracy and reliability are not too demanding.

By disregarding drift values and using simplified ways of system clock adjustment methods (often simple time stepping), SNTP client achieves only a low-quality time synchronization when compared with a full NTP implementation.

SNTP version 4 is defined in RFC2030, where it reads: *"It is strongly recommended that SNTP be used only at the extremities of the synchronization subnet. SNTP clients should operate only at the leaves (highest stratum) of the subnet and in configurations where no NTP or SNTP client is dependent on another SNTP client for synchronization. SNTP servers should operate only at the root (stratum 1) of the subnet and then only in configurations where no other source of synchronization other than a reliable radio or modem time service is available. The full degree of reliability ordinarily expected of primary servers is possible only using the redundant sources, diverse subnet paths and crafted algorithms of a full NTP implementation "*

Therefore, SNTP servers can supports both NTP and SNTP clients if server provides reliable high security and trustable source of time. In all other term "NTP time server" or "NTP compatible client" can - by definition - describe a system with a fully implemented NTP as well as any other product which uses and understands the NTP protocol but achieves far worse levels of reliability, accuracy and security

## . **PTP – Precision Time Protocol (IEEE1588)**

The Precision Time Protocol (PTP) is a protocol used to synchronize clocks throughout a computer network. On a local area network, it achieves clock accuracy in the sub-microsecond range, making it suitable for measurement and control systems. IEEE 1588 is designed for local systems requiring accuracies beyond those attainable using NTP.

The IEEE 1588 standards describe a hierarchical master-slave architecture for clock distribution. Under this architecture, a time distribution system consists of one or more communication media (network segments), and one or more clocks. An ordinary clock is a device with a single network connection and is either the source of (PTP-master) or destination for (PTP-slave) a synchronization reference. A boundary clock has multiple network connections and can accurately synchronize one network segment to another. A synchronization PTP-master is selected for each of the network segments in the system. The root timing reference is called the grandmaster. The grandmaster transmits synchronization information to the clocks residing on its network segment. The boundary clocks with a presence on that segment then relay accurate time to the other segments to which they are also connected.

A simplified PTP system frequently consists of ordinary clocks connected to a single network, and no boundary clocks are used. A grandmaster is selected, and all other clocks synchronize directly to it.

IEEE 1588: 2008 standard introduces a clock associated with network equipment used to convey PTP messages. The transparent clock modifies PTP messages as they pass through the device. Timestamps in the messages are corrected for time spent traversing the network equipment. This scheme improves distribution accuracy by compensating for delivery variability across the network.

PTP typically uses the same epoch as Unix time (start of 1 January 1970). While the Unix time is based on Coordinated Universal Time (UTC) and is subject to leap seconds, PTP is based on International Atomic Time (TAI). The PTP grandmaster communicates the current offset between UTC and TAI, so that UTC can be computed from the received PTP time.

## . **DEYTIME RFC867 RFC868**

When NTP on LAN1-LAN2 are operational they automatically also support older Unix DAYTIME RFC687 and RFC688. No additional configuration is required for DAYTIME



# APPENDIX

For detailed product technical specification please visit:

[www.elpromatime.com](http://www.elpromatime.com)

tel. +48 227517680 fax. +48227517681